



**Urology Instruments**  
**Instrumentais para Urologia**  
**Instrumentes Urologiques**

**Tel# 0092-52-4260785**

**Fax# 0092-52-4266804**

**Email. [Info@benison.com.pk](mailto:Info@benison.com.pk)**

**Urethral Sounds, Metal Catheters**
 $\frac{1}{4}$ 

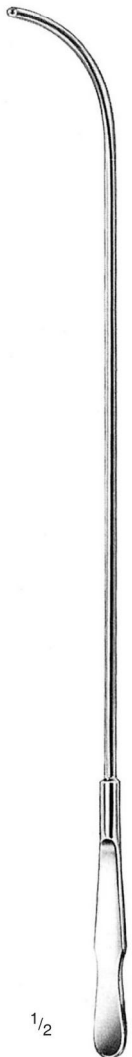
 $\frac{1}{2}$ 

**VAN BUREN**  
**39.06.08 – 39.06.30**  
 27.5 cm / 11"  
 Charrier (French)  
 No. (8-30)

 $\frac{1}{4}$ 

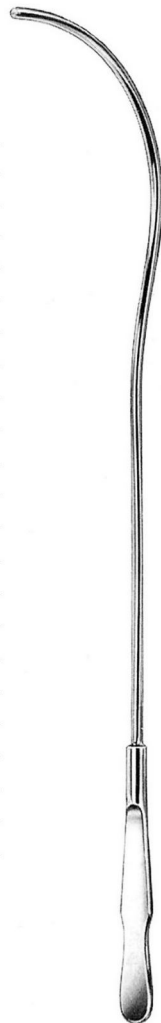
 $\frac{1}{2}$ 

**GUYON**  
**39.07.10 – 39.07.30**  
 27.5 cm / 11"  
 Charrier (French)  
 No. (10-30)

**CHARRIERE**  
 (French)

VAN BUREN		GUYON
<b>39.06.08</b>	8	–
<b>39.06.10</b>	10	<b>39.07.10</b>
	11	<b>39.07.11</b>
<b>39.06.12</b>	12	<b>39.07.12</b>
	13	<b>39.07.13</b>
<b>39.06.14</b>	14	<b>39.07.14</b>
	15	<b>39.07.15</b>
<b>39.06.16</b>	16	<b>39.07.16</b>
	17	<b>39.07.17</b>
<b>39.06.18</b>	18	<b>39.07.18</b>
	19	<b>39.07.19</b>
<b>39.06.20</b>	20	<b>39.07.20</b>
	21	<b>39.07.21</b>
<b>39.06.22</b>	22	<b>39.07.22</b>
	23	<b>39.07.23</b>
<b>39.06.24</b>	24	<b>39.07.24</b>
	25	<b>39.07.25</b>
<b>39.06.26</b>	26	<b>39.07.26</b>
	27	<b>39.07.27</b>
<b>39.06.28</b>	28	<b>39.07.28</b>
	29	<b>39.07.29</b>
<b>39.06.30</b>	30	<b>39.07.30</b>

**39.06.00**                      **39.07.00**  
 (Set of 12, pcs)              (Set 21, pcs)



 $\frac{1}{2}$ 

**39.07.56 – 39.07.66**  
 Charrier (French)  
 No. 6-16,  
 16 cm / 6  $\frac{1}{4}$ "

 Charriere  
 (French)

<b>39.07.56</b>	– 6
<b>39.07.58</b>	– 8
<b>39.07.60</b>	– 10
<b>39.07.62</b>	– 12
<b>39.07.63</b>	– 13
<b>39.07.64</b>	– 14
<b>39.07.65</b>	– 15
<b>39.07.66</b>	– 16

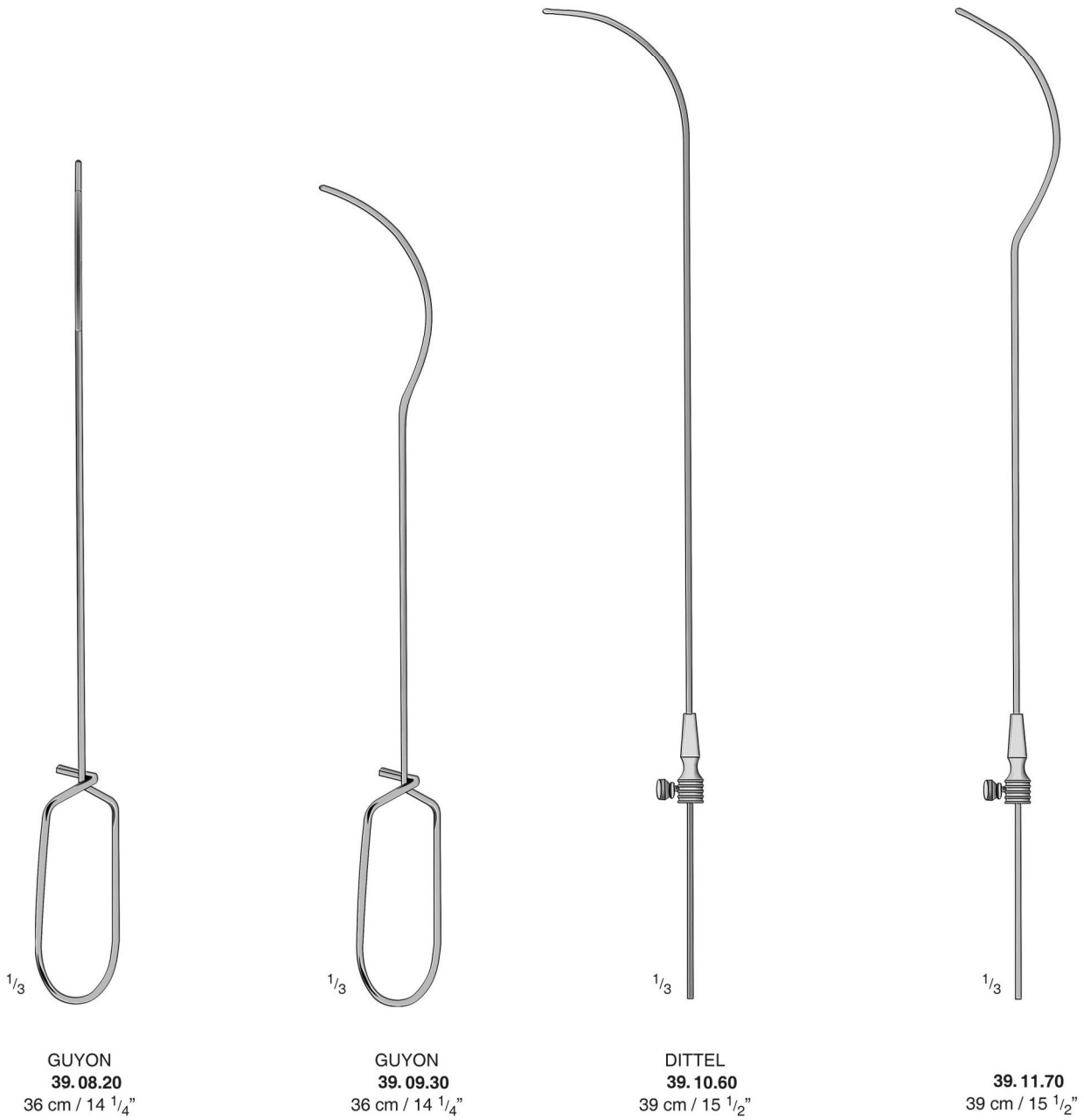
Catheter Guides



**Bladder Spatula & Retractors**



LEGUEU  
39.16.15  
27 cm / 10 1/2"

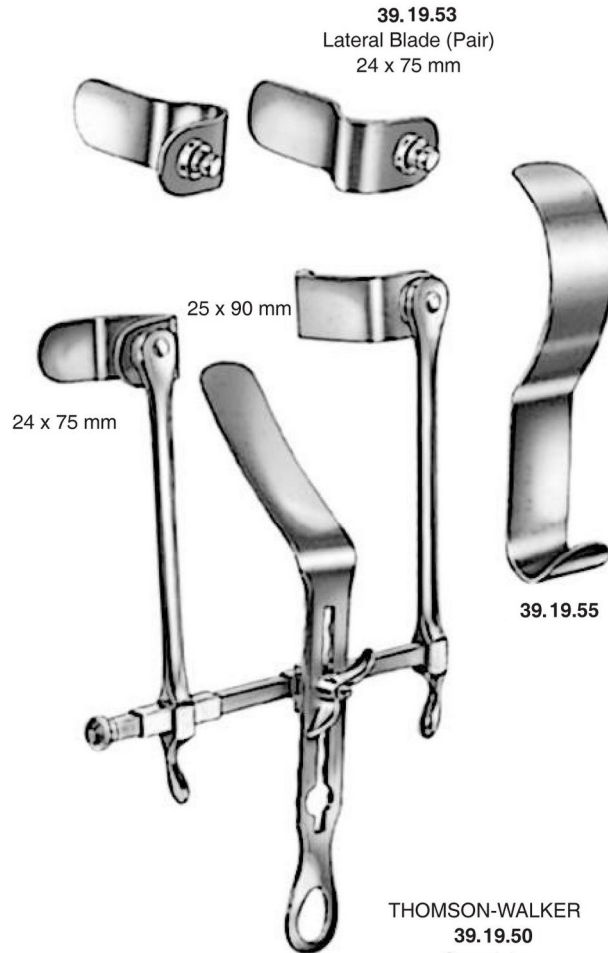

THOMSON-WALKER  
39.19.50  
Complete



HRYNTSHCAK  
39.20.70

**Prostatic Retractors, Prostatic Instruments**

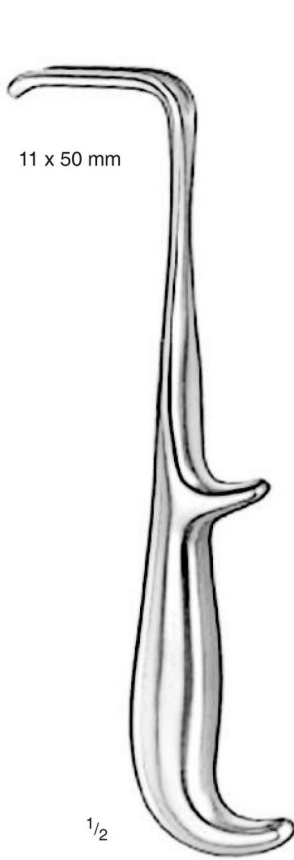

YOUNG  
39. 23.01  
21 cm / 8 1/4"



YOUNG  
39. 24.02  
22 cm / 8 3/4"



YOUNG  
39. 25.03  
21 cm / 8 1/4"

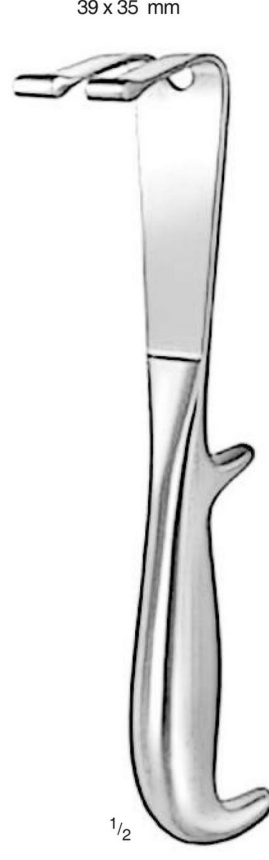

YOUNG  
39. 28.04  
22 cm / 8 3/4"

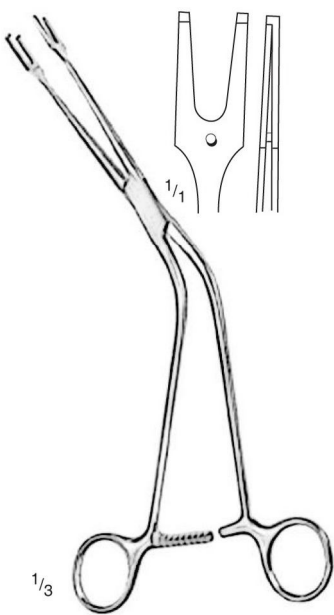

MILLIN  
39. 26.03  
24 cm / 9 1/2"

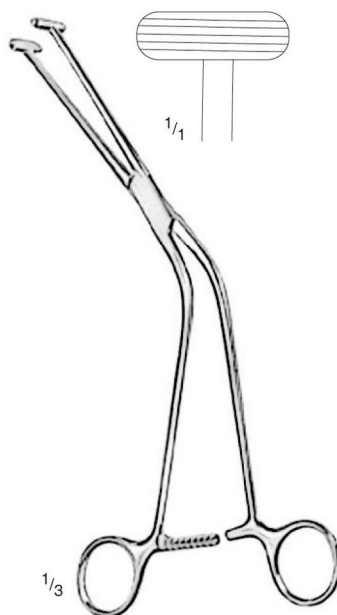

MILLIN  
39. 31.01  
23 cm / 9"

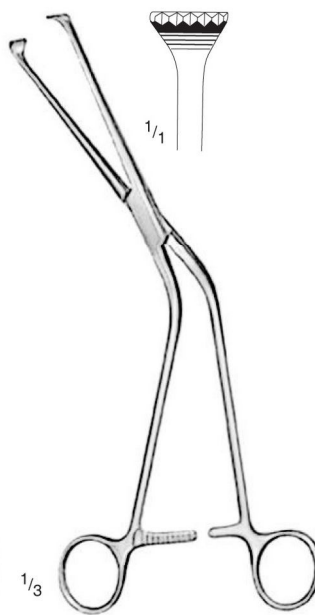

MILLIN  
39. 32.02  
23 cm / 9"

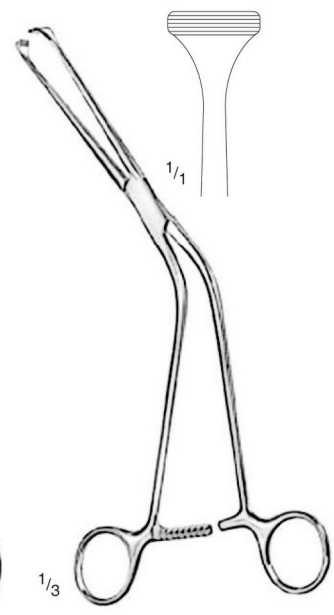

MILLIN  
39. 32.04  
23 cm / 9"

Bladder Neck Spreader, Meatus Clamps, Foreign Body Forceps



MILLIN  
39.33.50  
28 cm / 11"

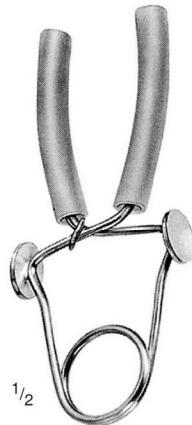

STRAUSS  
39.04.10  
12 cm / 4 3/4"



STOCKMANN  
39.05.05  
8 cm / 3 1/8"

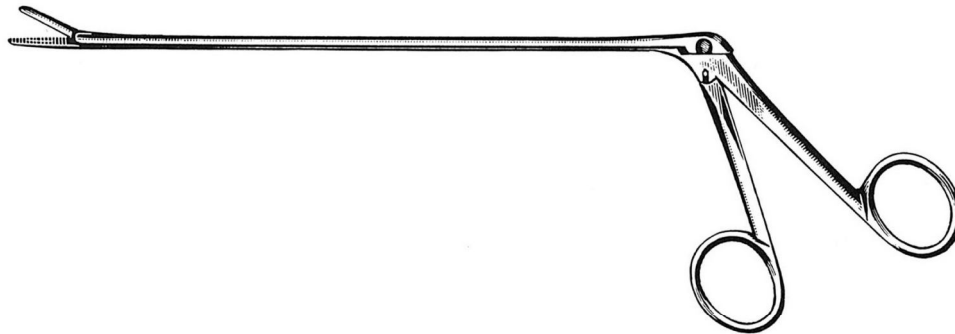

MATHIEU  
39.21.20 - 20 cm / 8"  
39.21.28 - 28 cm / 11"

**Kidney Stone Forceps**

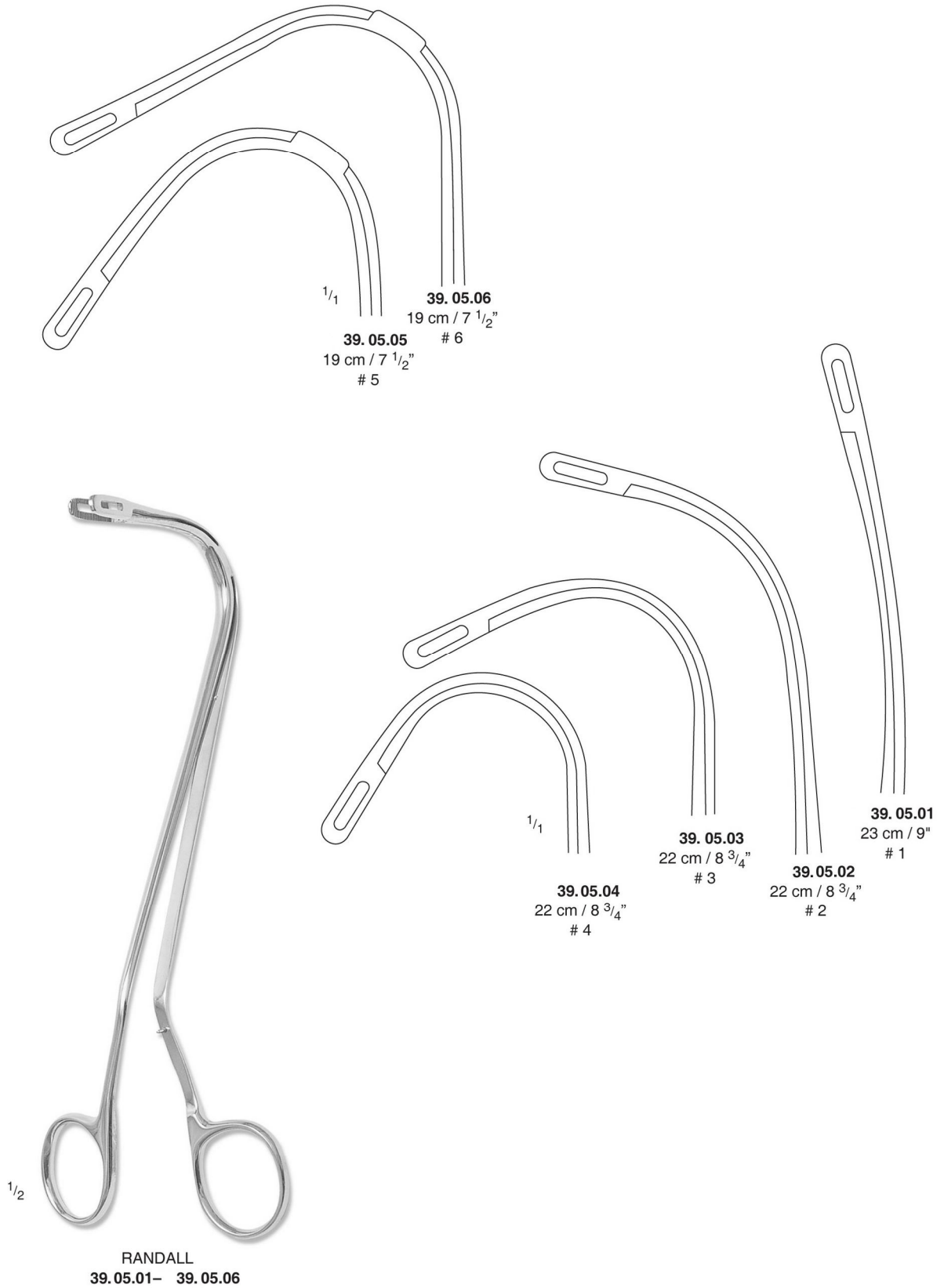



**Kidney Pedical Clamps, Vaginal Forceps**



GUYON  
39. 15.20 – 39. 15.24

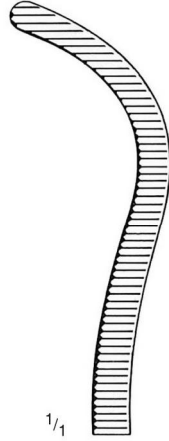

39. 15.20  
20 cm / 8"

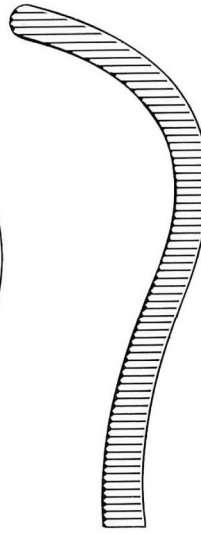

39. 15.22  
22 cm / 8 3/4"

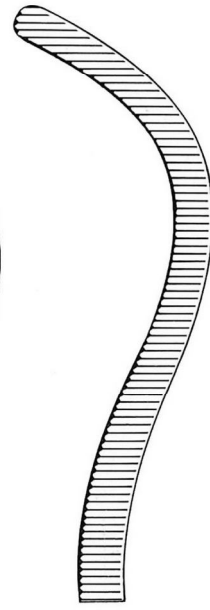

39. 15.24  
24 cm / 9 1/2"

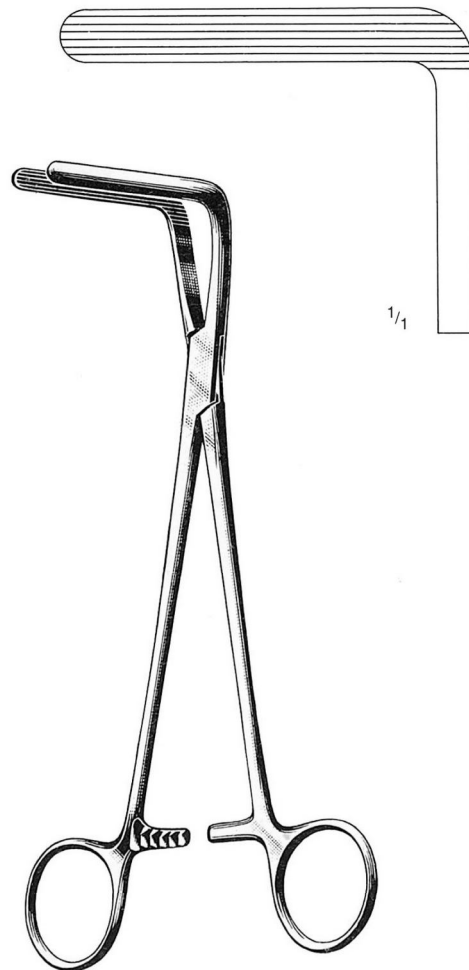

WERTHEIM-CULLEN  
39. 04.23  
23 cm / 9"



**Kidney Pedicle Clamps**

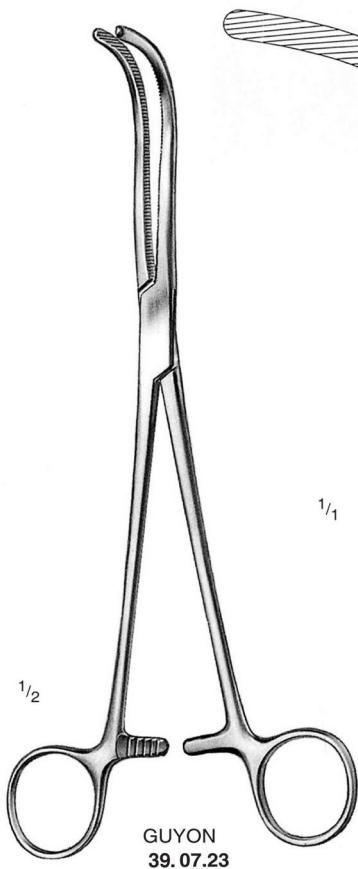

GUYON  
39.07.23



GUYON-MAYO  
39.08.23  
23 cm / 9"

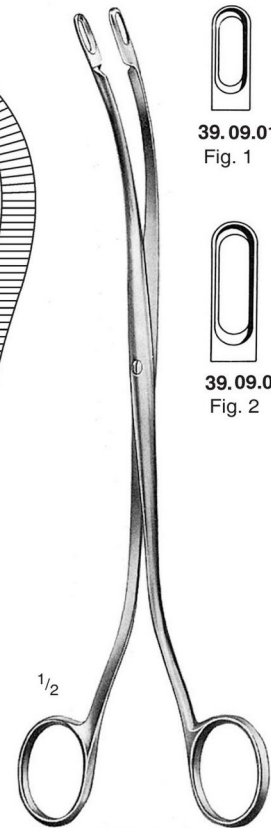

DESJARDINS  
39.09.01 - 39.09.02  
23 cm / 9"

39.09.01  
Fig. 1

39.09.02  
Fig. 2

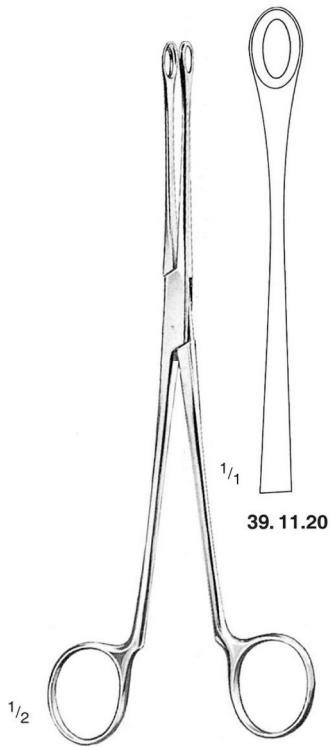

BLAKE  
39.11.20 - 39.12.20  
20 cm / 8"

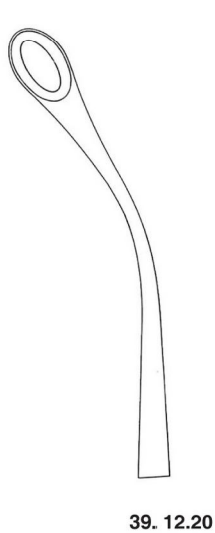

39.12.20



MAYO-BLAKE  
39.13.20  
20 cm / 8"

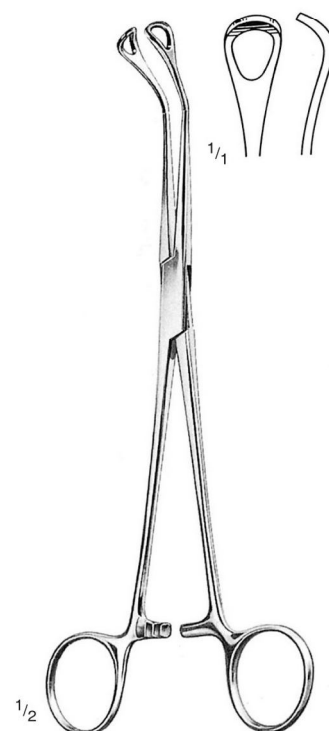

MAYO-BLAKE  
39.14.20  
20 cm / 8"

**Gall Bladder Scissors, Probes, Dilators**

**THOREK**  
39. 16.19 – 19 cm / 7 1/2"  
39. 16.23 – 23 cm / 9"

**DESJARDINS**  
39.36.01 – 39.36.03  
26 cm / 10 1/4"  
39. 36.00  
Set of 3 probes

**BAKES**  
39. 32.01 – 39. 32.13  
32 cm / 13"  
Malleable Shaft  
39. 32.00  
Set of 13 dilators

1 mm  
39. 32.01 # 1

2 mm  
39. 32.02 # 2

3 mm  
39. 32.03 # 3

4 mm  
39. 32.04 # 4

5 mm  
39. 32.05 # 5

6 mm  
39. 32.06 # 6

7 mm  
39. 32.07 # 7

8 mm  
39. 32.08 # 8

9 mm  
39. 32.09 # 9

10 mm  
39. 32.10 # 10

11 mm  
39. 32.11 # 11

12 mm  
39. 32.12 # 12

13 mm  
39. 32.13 # 13

Side View

1/2

1/2

1/4