

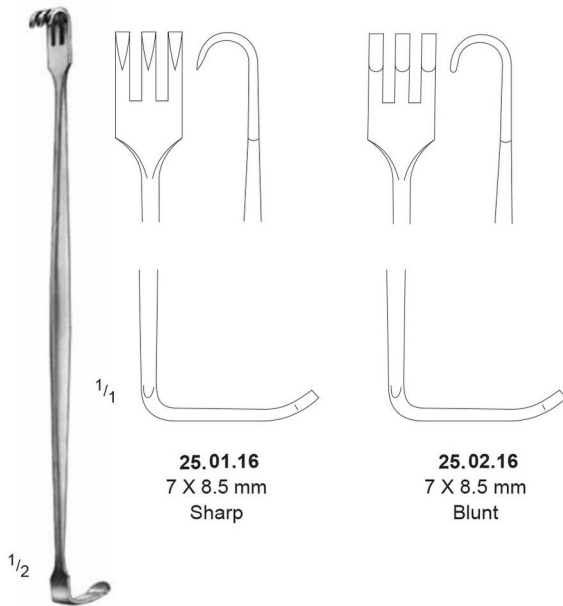

Retractors
Afastadores
Ecarteurs

Tel# 0092-52-4260785
Fax# 0092-52-4266804
Email. Info@benison.com.pk

Retractors, Vein Hooks



25.01.16
7 X 8.5 mm
Sharp

25.02.16
7 X 8.5 mm
Blunt

SEN MILLER
25.01.16 - 25.02.16
16 cm / 6 1/4"

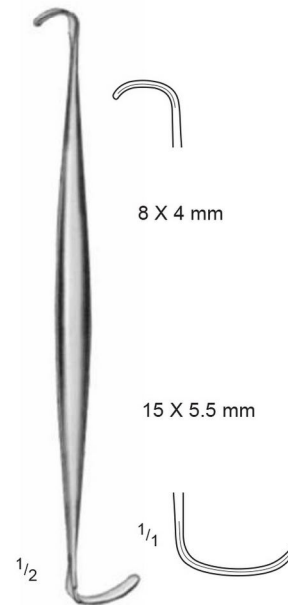

8 X 4 mm

15 X 5.5 mm

RAGNELL - DAVIS
25.05.16
16 cm / 6 1/4"

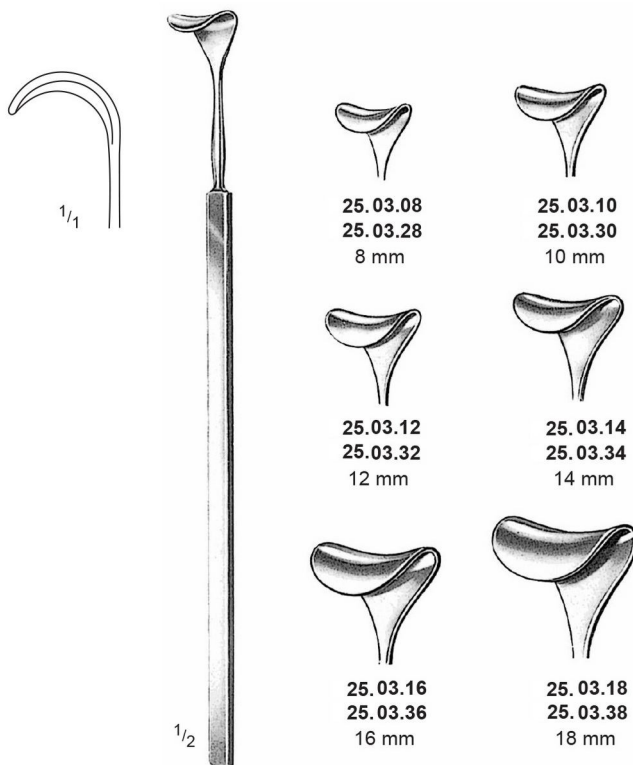

25.03.08
25.03.28
8 mm

25.03.10
25.03.30
10 mm

25.03.12
25.03.32
12 mm

25.03.14
25.03.34
14 mm

25.03.16
25.03.36
16 mm

25.03.18
25.03.38
18 mm

CUSHING
25.03.08 - 25.03.18
20 cm / 8"



CUSHING
25.03.28 - 25.03.38
24 cm / 9 1/2"

Hooks and Retractors

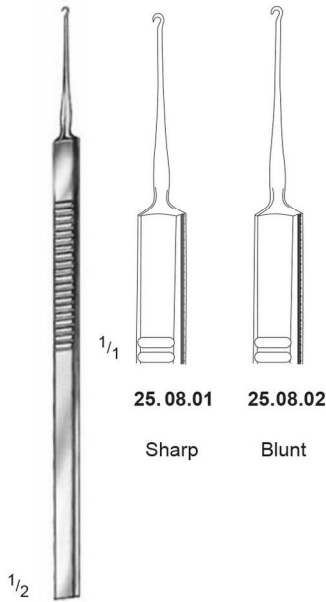

GRAEFE
25.08.01 - 25.08.02
16 cm / 6 1/4"

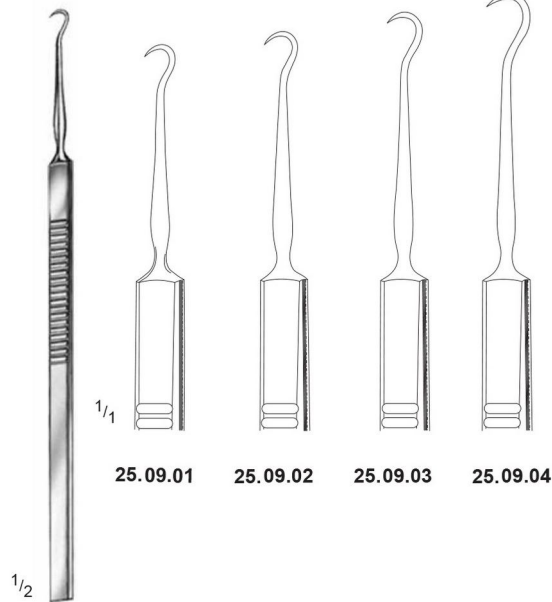

25.09.01 - 25.09.04
16 cm / 6 1/4"



GILLIES
25.12.19 - 25.12.20
19 cm / 7 1/2"

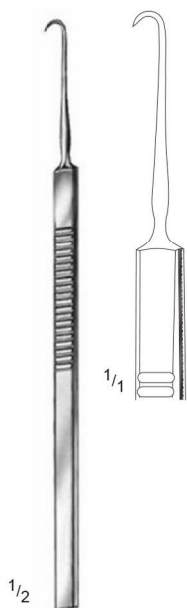

O'CONNOR
25.13.16
16 cm / 6 1/4"

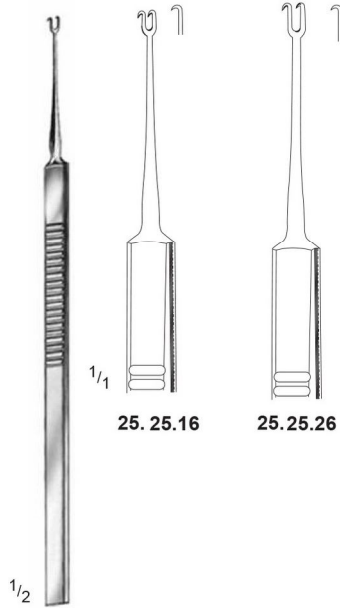

GUTHRIE
25.25.16 - 25.25.26
16 cm / 6 1/4"



25.26.16
16 cm / 6 1/4"

Retractors

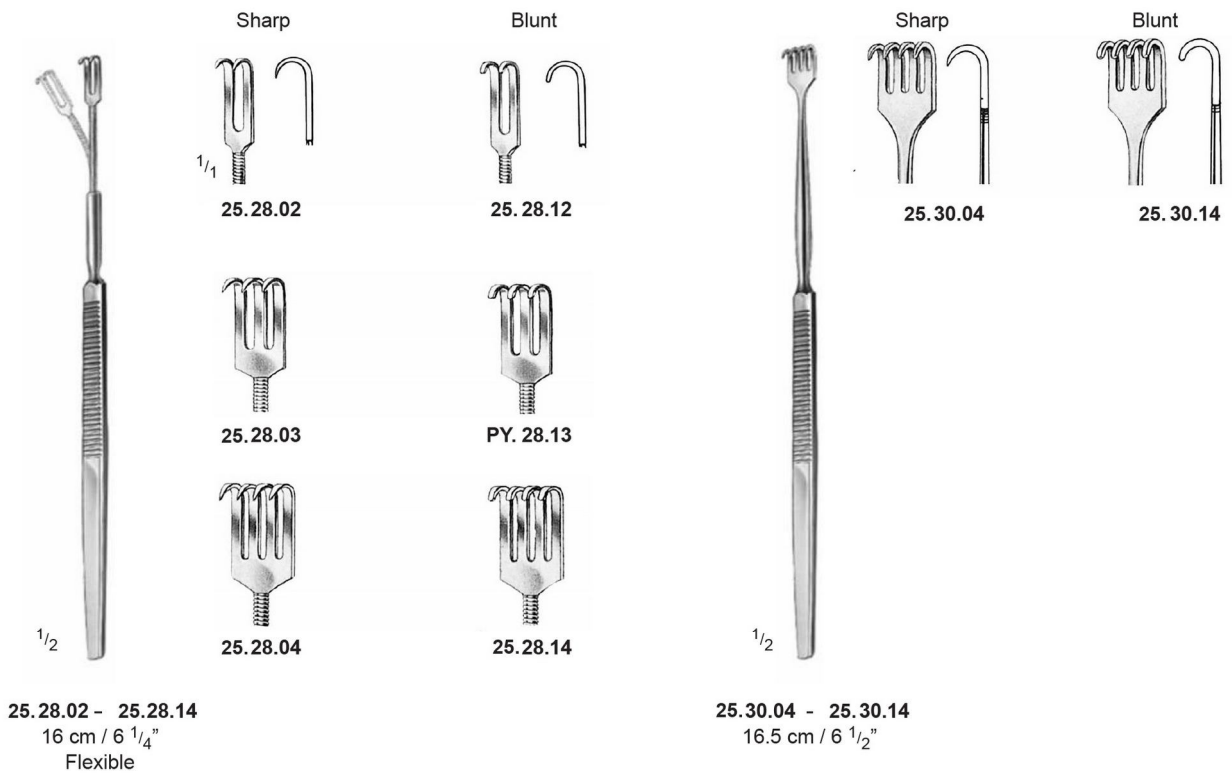
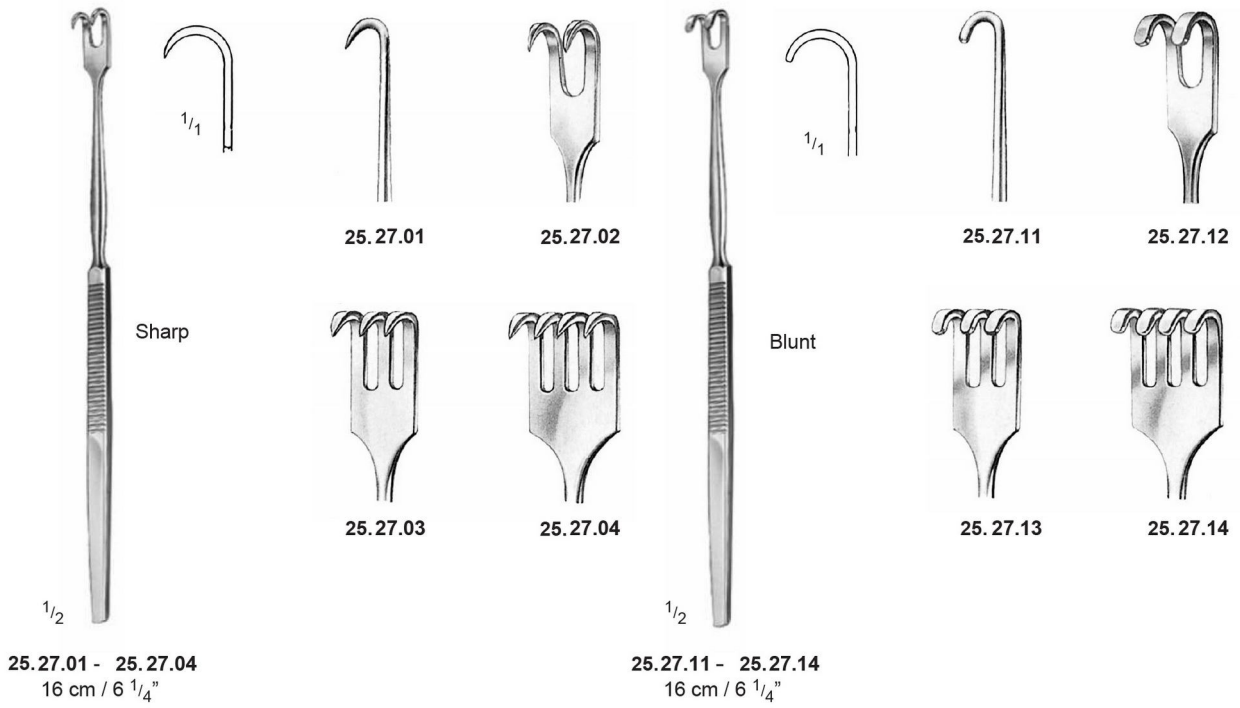

Retractors

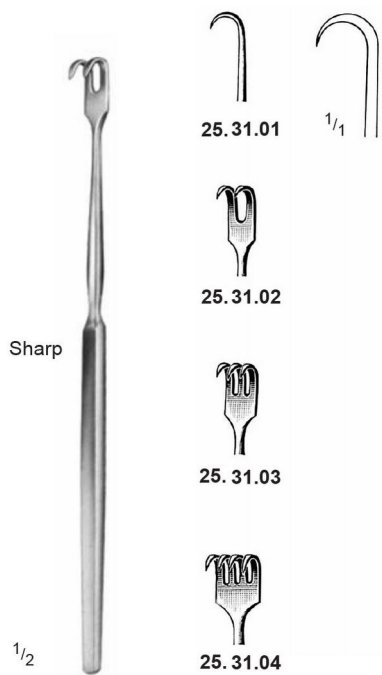

25.31.01 - 25.31.04
16.5 cm / 6 1/2"

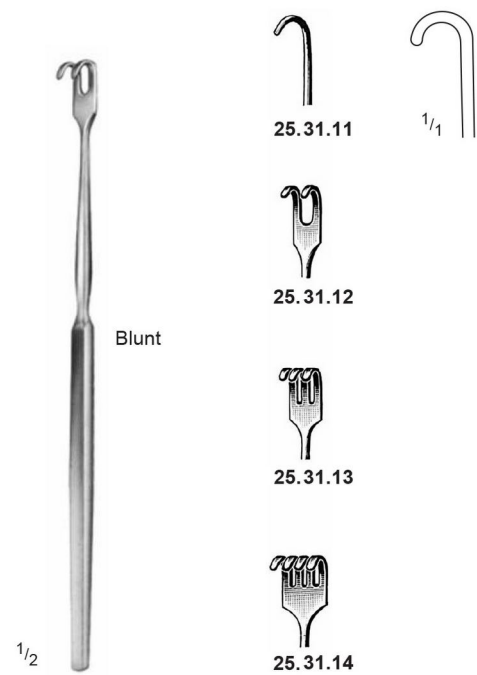

25.31.11 - 25.31.14
16.5 cm / 6 1/2"



MINI-LANGENBECK
25.32.10 - 25.32.22
16 cm / 6 1/4"

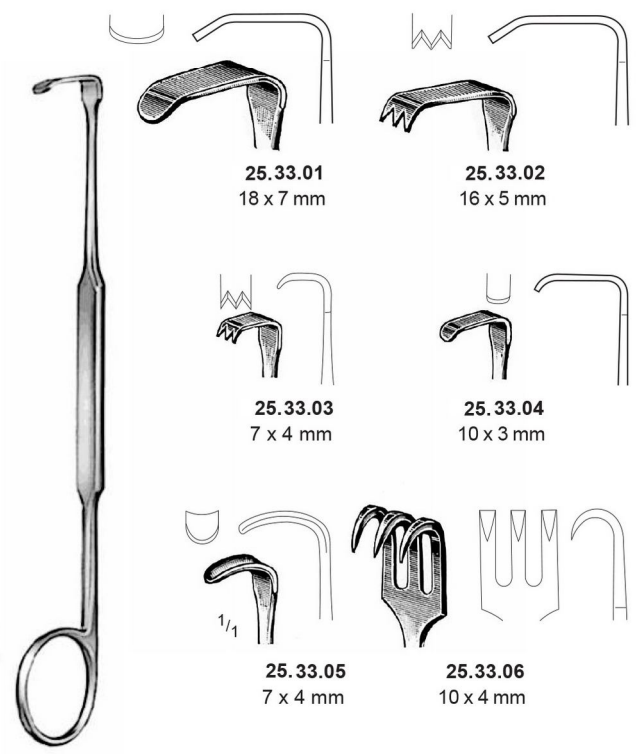

MEYERDING
25.33.01 - 25.33.06
18 cm / 7"

Abdominal Spatulas, Ribbon Retractors

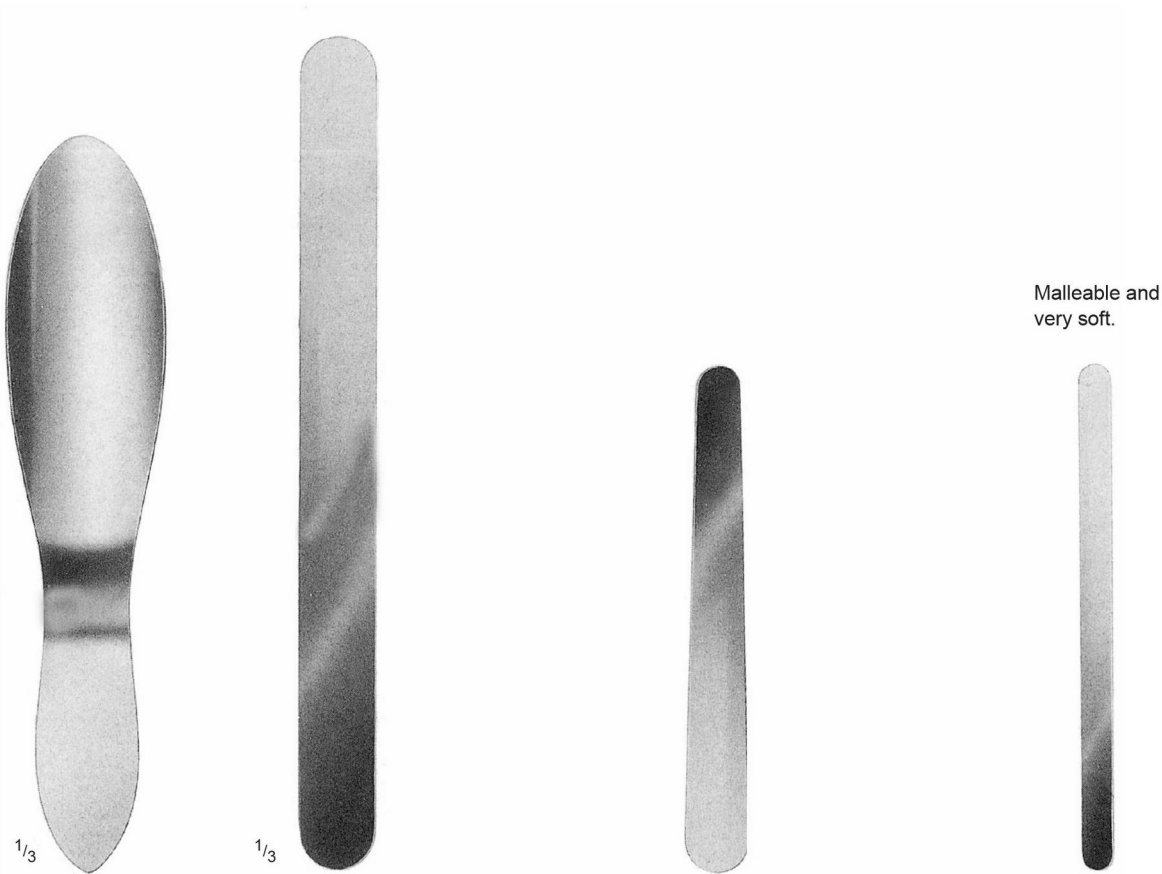

1/3

1/3

REVERDIN
25.36.28
28 cm / 11"
45 x 60 mm

OCHSNER
25.38.30 30 mm
25.38.40 40 mm
25.38.50 50 mm
33 cm / 13"

Flexible

HABERER
25.40.20
20 cm / 8", 17/25 mm
25.40.28
28 cm / 11", 25/30 mm
25.40.30
30 cm / 12", 37/45 mm

Flexible

Malleable and
very soft.

PROFESSIONAL
25.41.06 – 6 x 200 mm
25.41.10 – 10 x 200 mm
25.41.12 – 12 x 200 mm
25.41.17 – 17 x 200 mm
25.41.20 – 20 x 200 mm
25.41.25 – 25 x 200 mm
25.41.55 – 27 x 250 mm
25.41.65 – 35 x 250 mm

Retractors

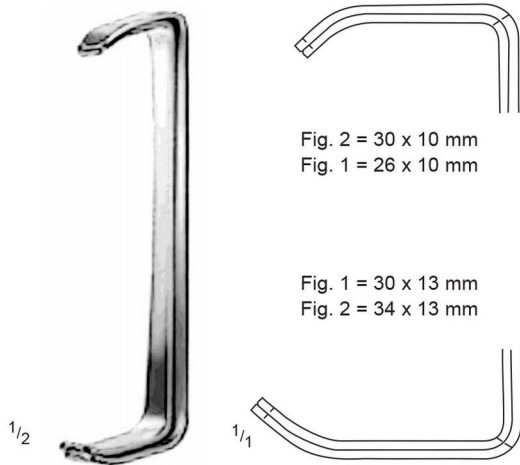

FARABEU
25.46.12 – Set of 2
12 cm / 4 3/4"

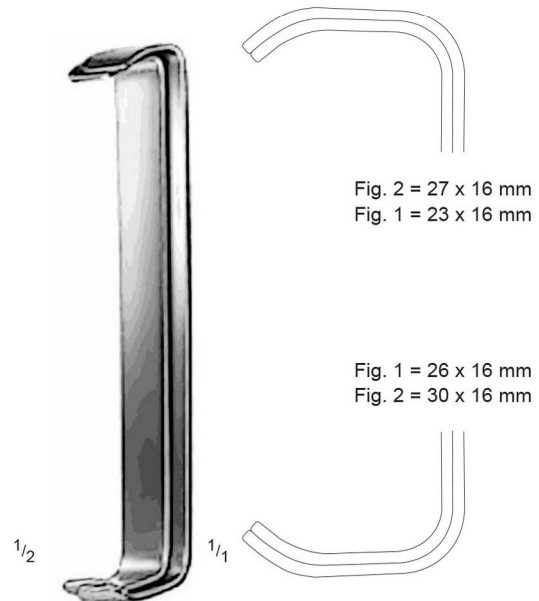

FARABEU
25.47.15 – Set of 2
15 cm / 6"

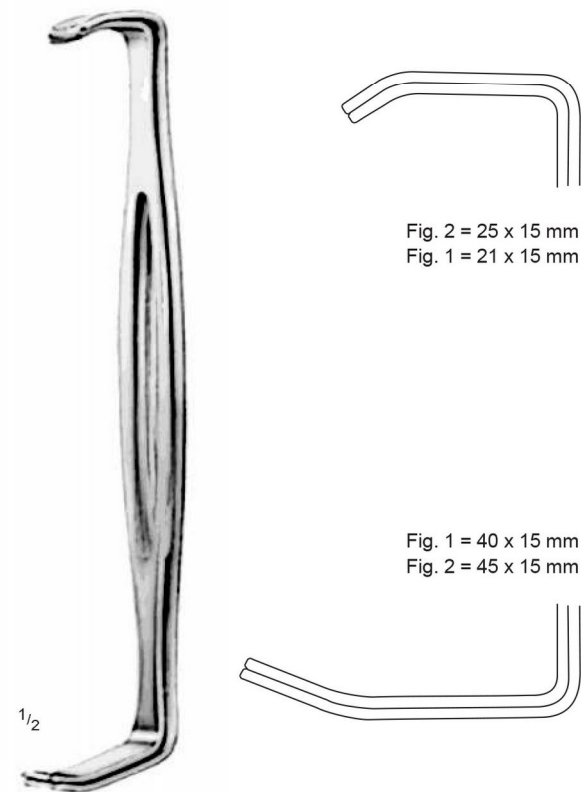

PARKER - LANGENBECK
25.48.21 – Set of 2
21 cm / 8 1/4"

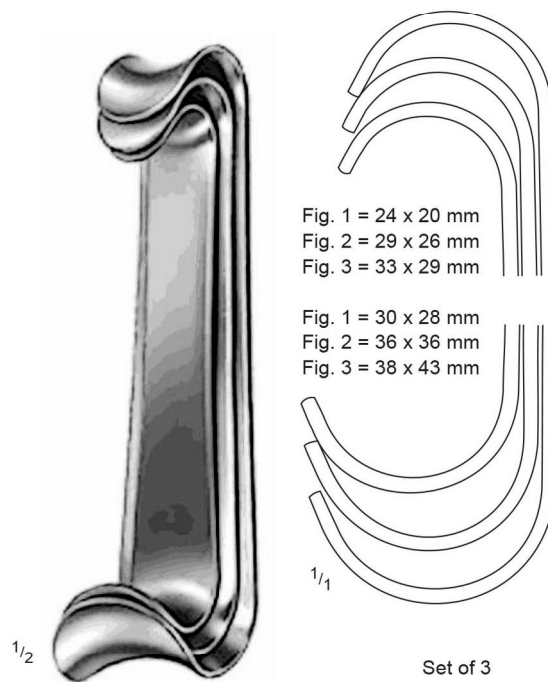

ROUX
25.49.01 – Fig 1 = 15 cm / 6"
25.49.02 – Fig 2 = 16 cm / 6 1/4"
25.49.03 – Fig 3 = 17 cm / 6 3/4"

Set of 3
25.49.10

Retractors, Hooks

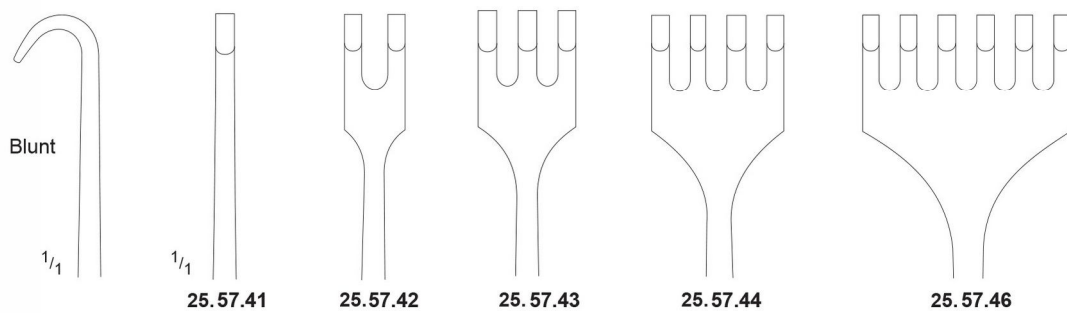
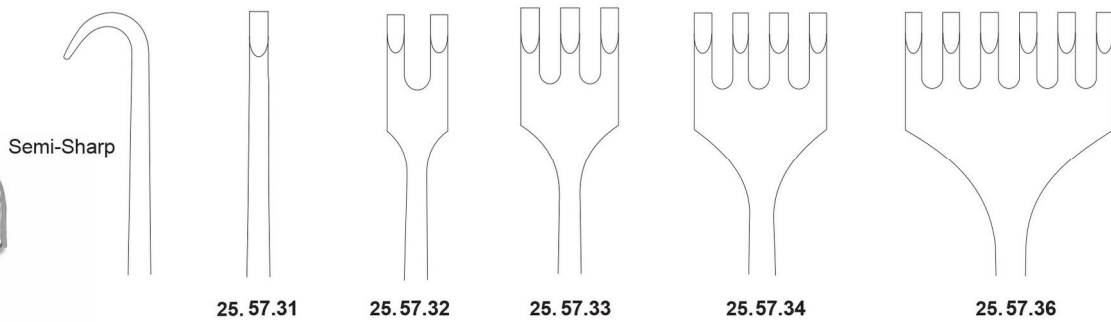
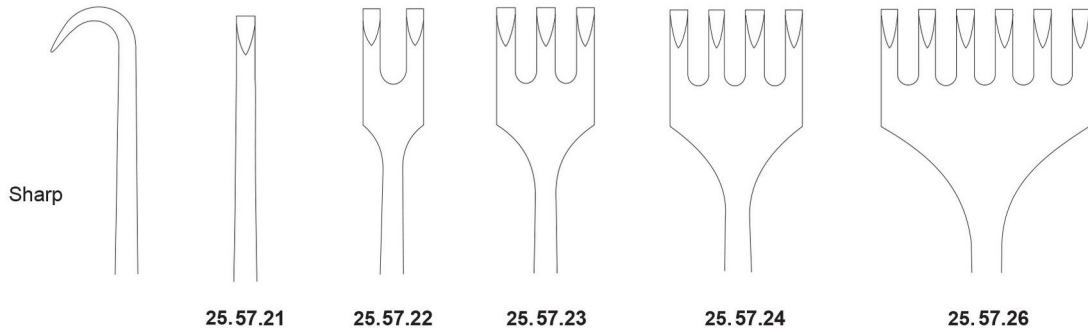

VOLKMANN
25.57.21 - 25.62.22
22 cm / 8 $\frac{3}{4}$ "

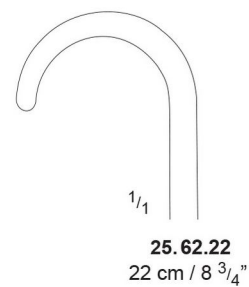
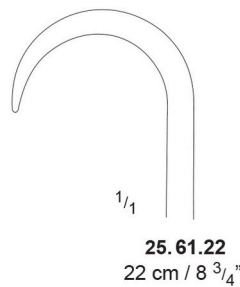

Retractors



Blunt

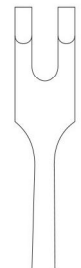

25.58.02

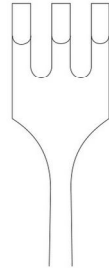

25.58.03

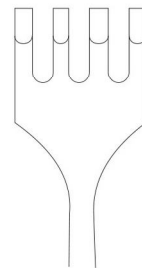

25.58.04

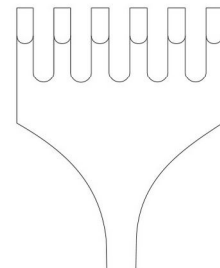

25.58.06

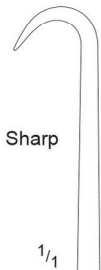

Sharp

1/1

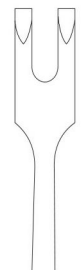

25.58.22

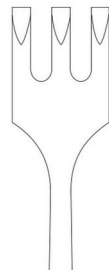

25.58.23

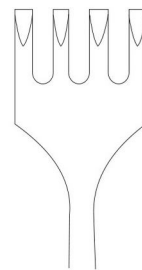

25.58.24

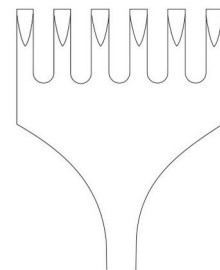

25.58.26

1/2

VOLKMANN
25.58.02 - 25.58.26
21.5 cm / 8 1/2"

Retractors



Sharp



25.63.02



25.63.03

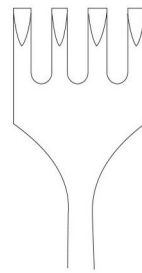

25.63.04

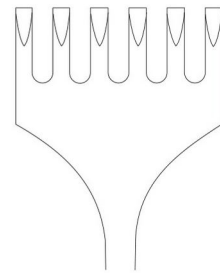

25.63.06

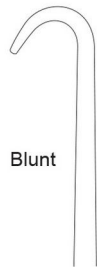

Blunt



25.63.07

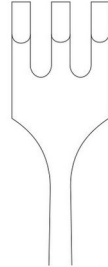

25.63.08

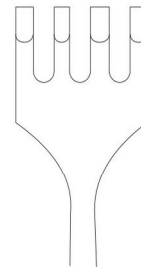

25.63.09

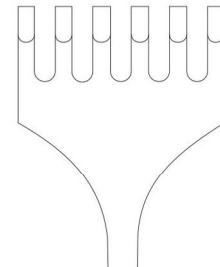

25.63.10



Semi Sharp

$\frac{1}{4}$



25.63.12



25.63.13

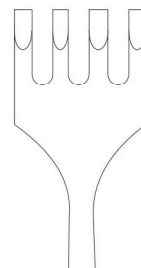

25.63.14

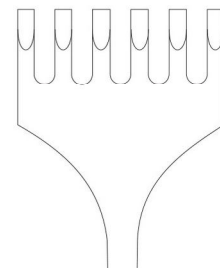

25.63.16



$\frac{1}{2}$

KOCHER

25.63.02 - 25.63.16

22 cm / 8 $\frac{3}{4}$ "

Retractors

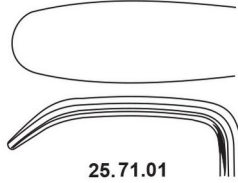

25.71.01
25.72.01
30 x 11 mm

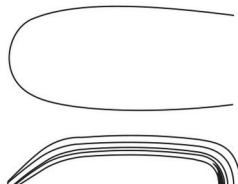

25.71.02
25.72.02
30 x 14 mm

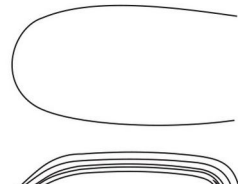

25.71.03
25.72.03
30 x 16 mm

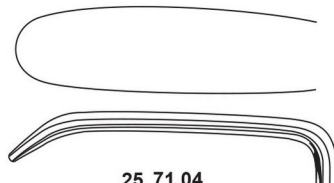

25.71.04
25.72.04
40 x 11 mm

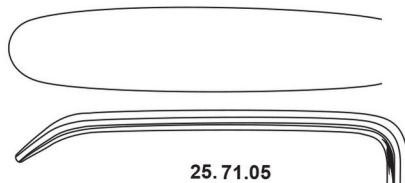

1/4
25.71.05
25.72.05
50 x 11 mm



1/2

LANGENBECK
25.71.01 - 25.71.05
21 cm / 8 1/4"



1/2

LANGENBECK
25.72.01 - 25.72.05
21 cm / 8 1/4"

Retractors

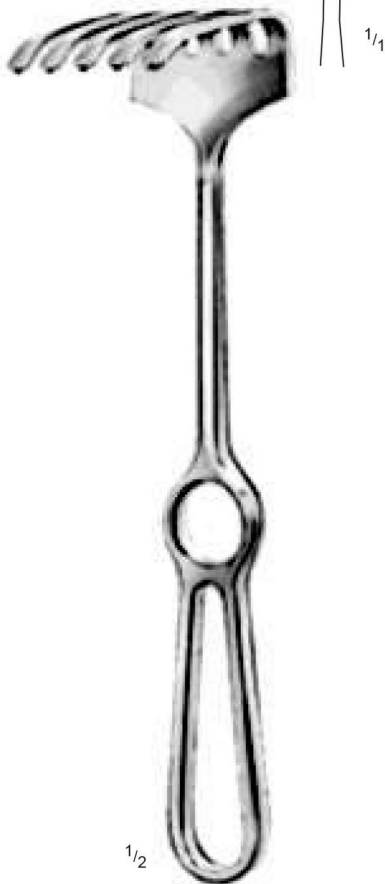
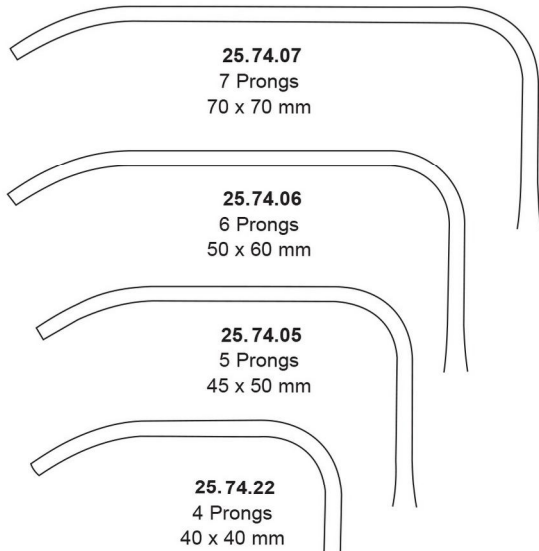

ISRAEL
25.74.07 - 25.74.22
25 cm / 10"

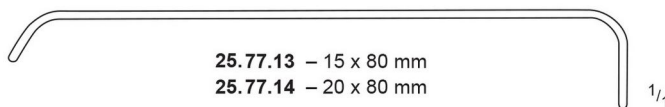
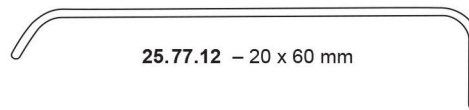
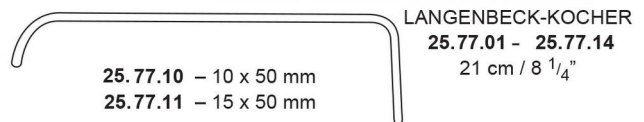
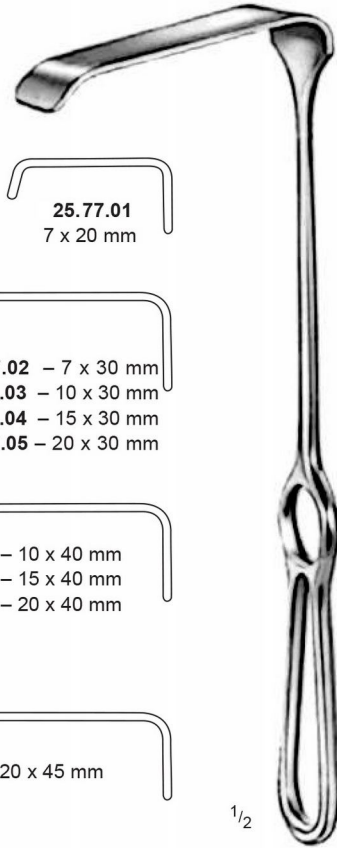

Retractors

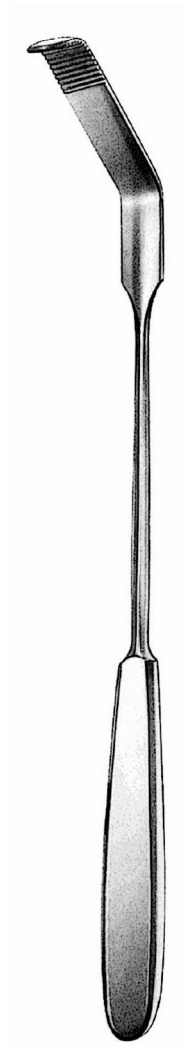

ZENKER
25.84.25 - 25.86.99

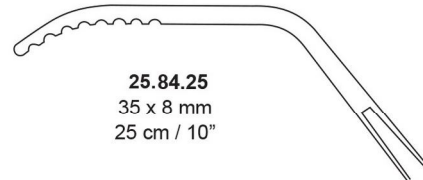

25.84.25
35 x 8 mm
25 cm / 10"

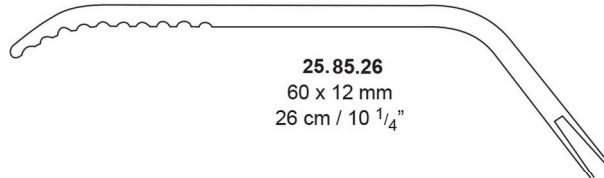

25.85.26
60 x 12 mm
26 cm / 10 1/4"

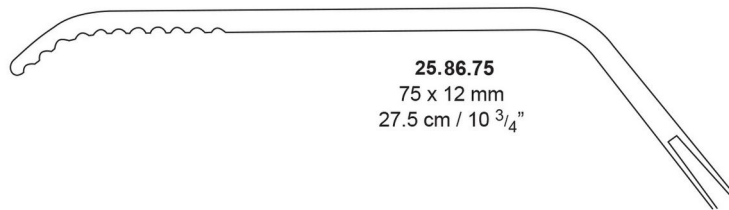

25.86.75
75 x 12 mm
27.5 cm / 10 3/4"

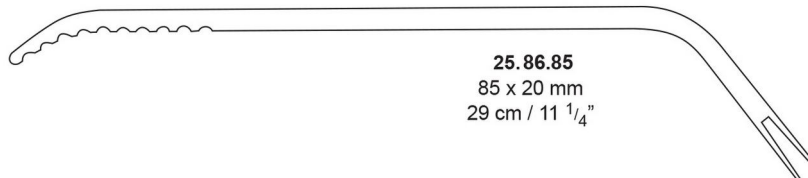

25.86.85
85 x 20 mm
29 cm / 11 1/4"

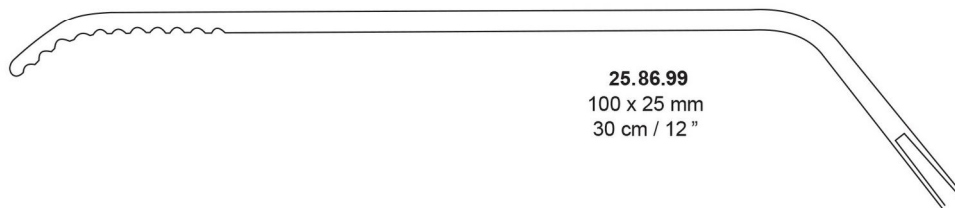

25.86.99
100 x 25 mm
30 cm / 12"

Retractors

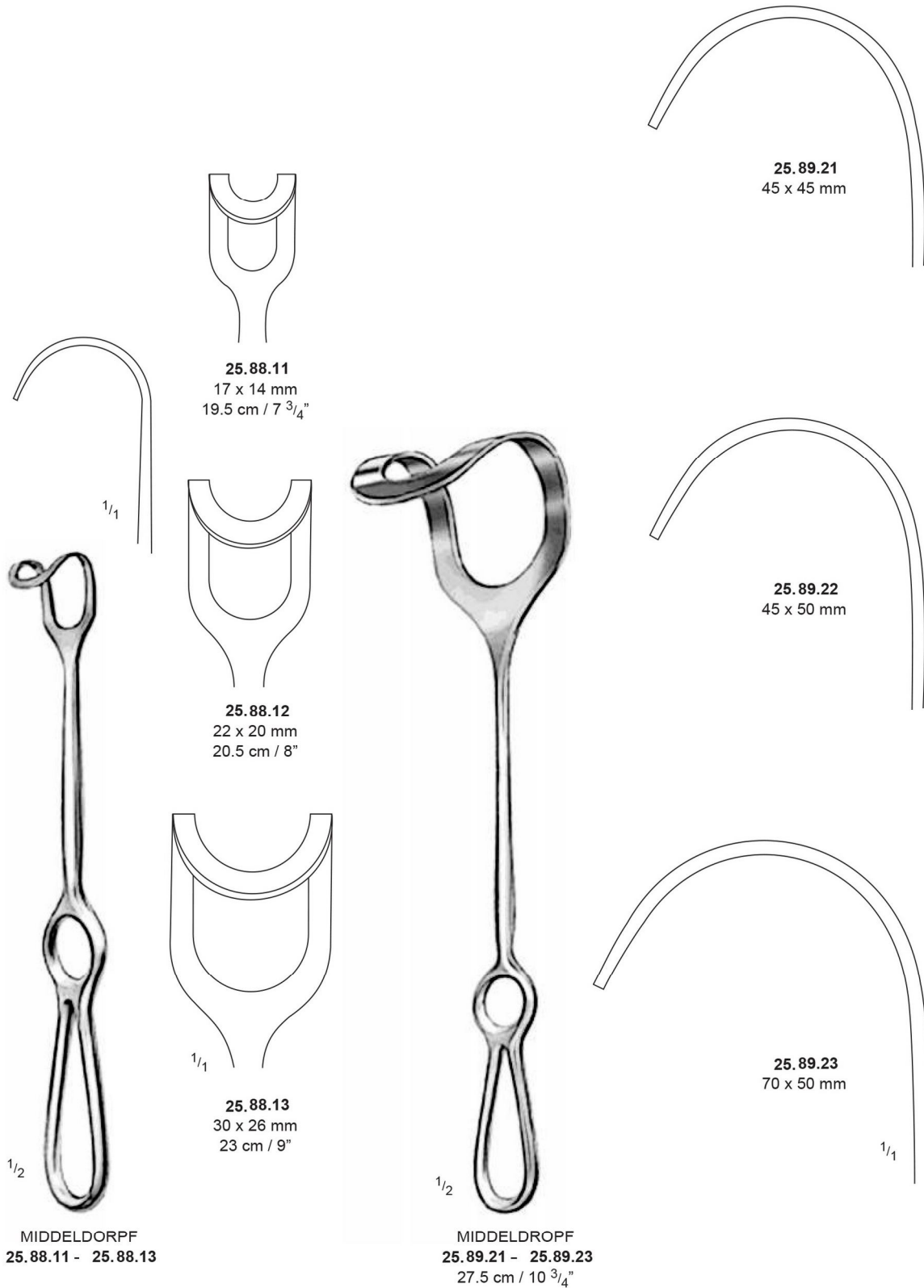

Retractors

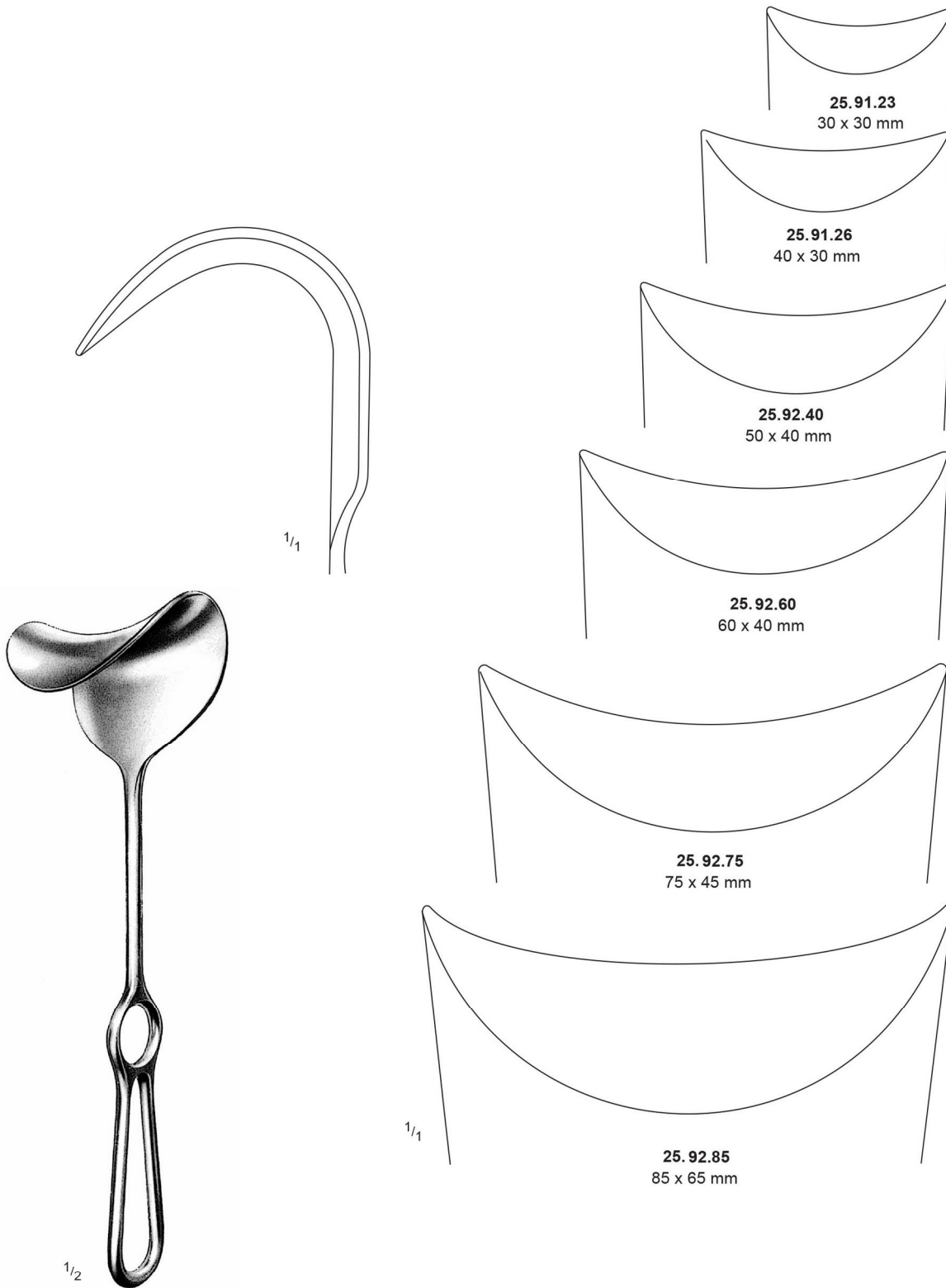

FRITSCH
25.91.23 - 25.92.85
23 cm / 9"

Retractors

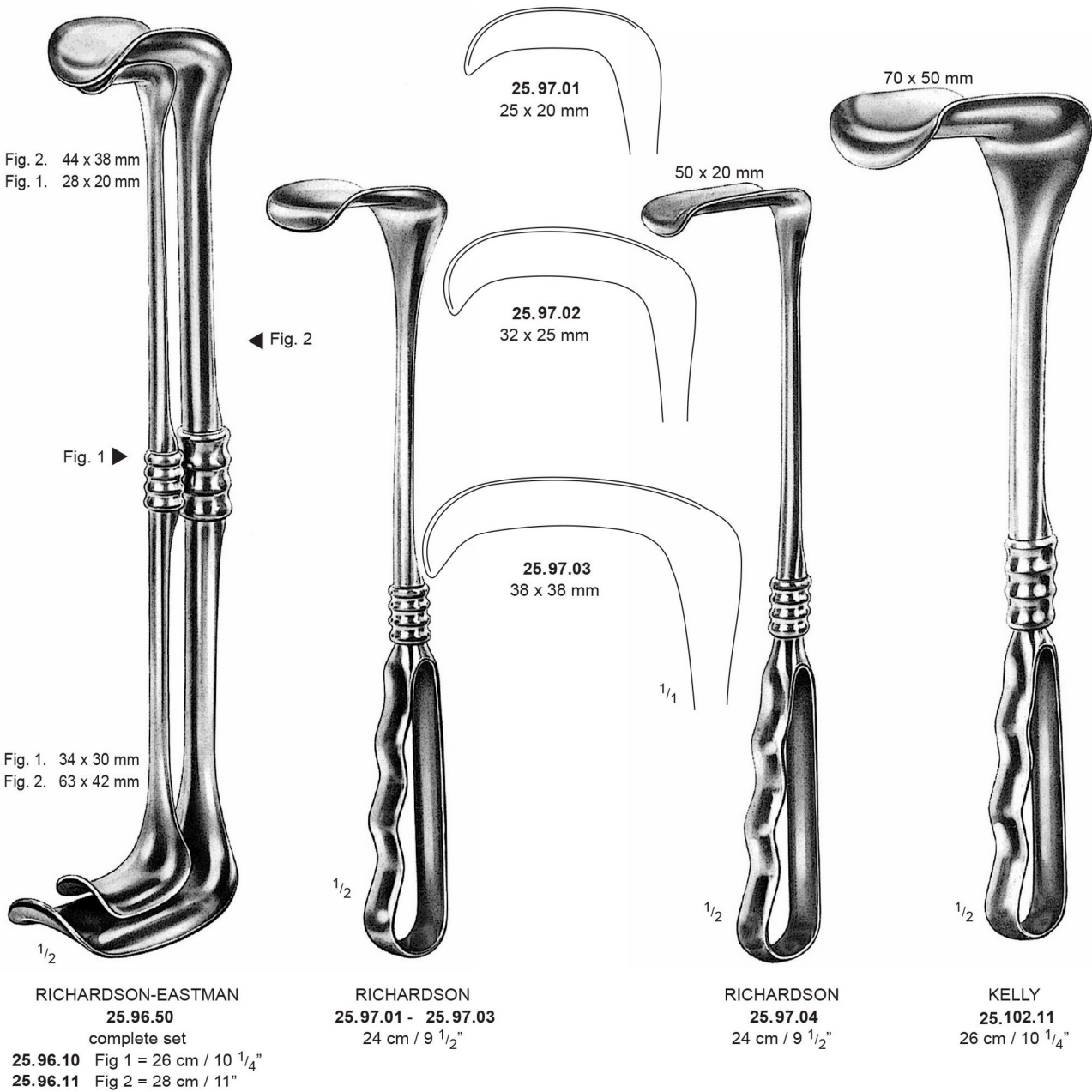

Retractors

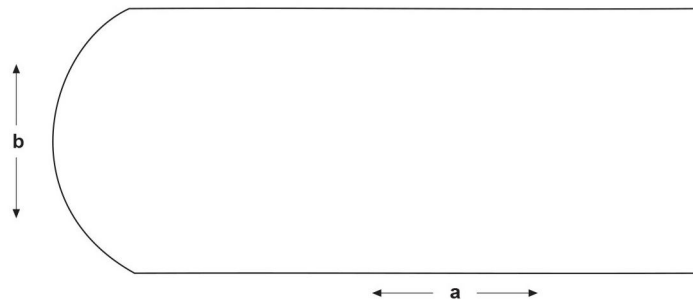

DOYEN
25.94.80
24 cm / 9 1/2"

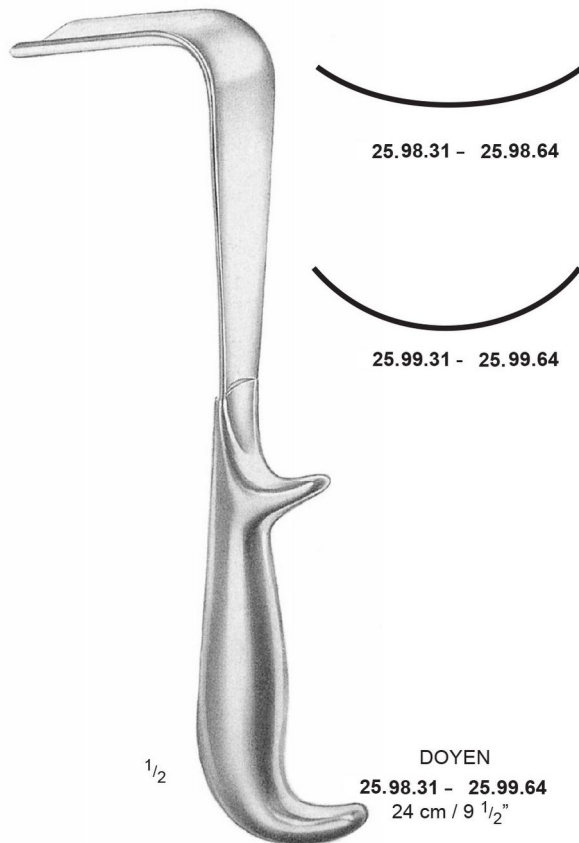

a	b	Slightly Concave	Medium Hollow
mm	mm		
55	35	25.98.31	25.99.31
85	35	25.98.32	25.99.32
115	35	25.98.33	25.99.33
55	45	25.98.41	25.99.41
85	45	25.98.42	25.99.42
115	45	25.98.43	25.99.43
160	45	25.98.44	25.99.44
55	60	25.98.61	25.99.61
85	60	25.98.62	25.99.62
115	60	25.98.63	25.99.63
160	60	25.98.64	25.99.64

Retractors



Splanchin Retractors

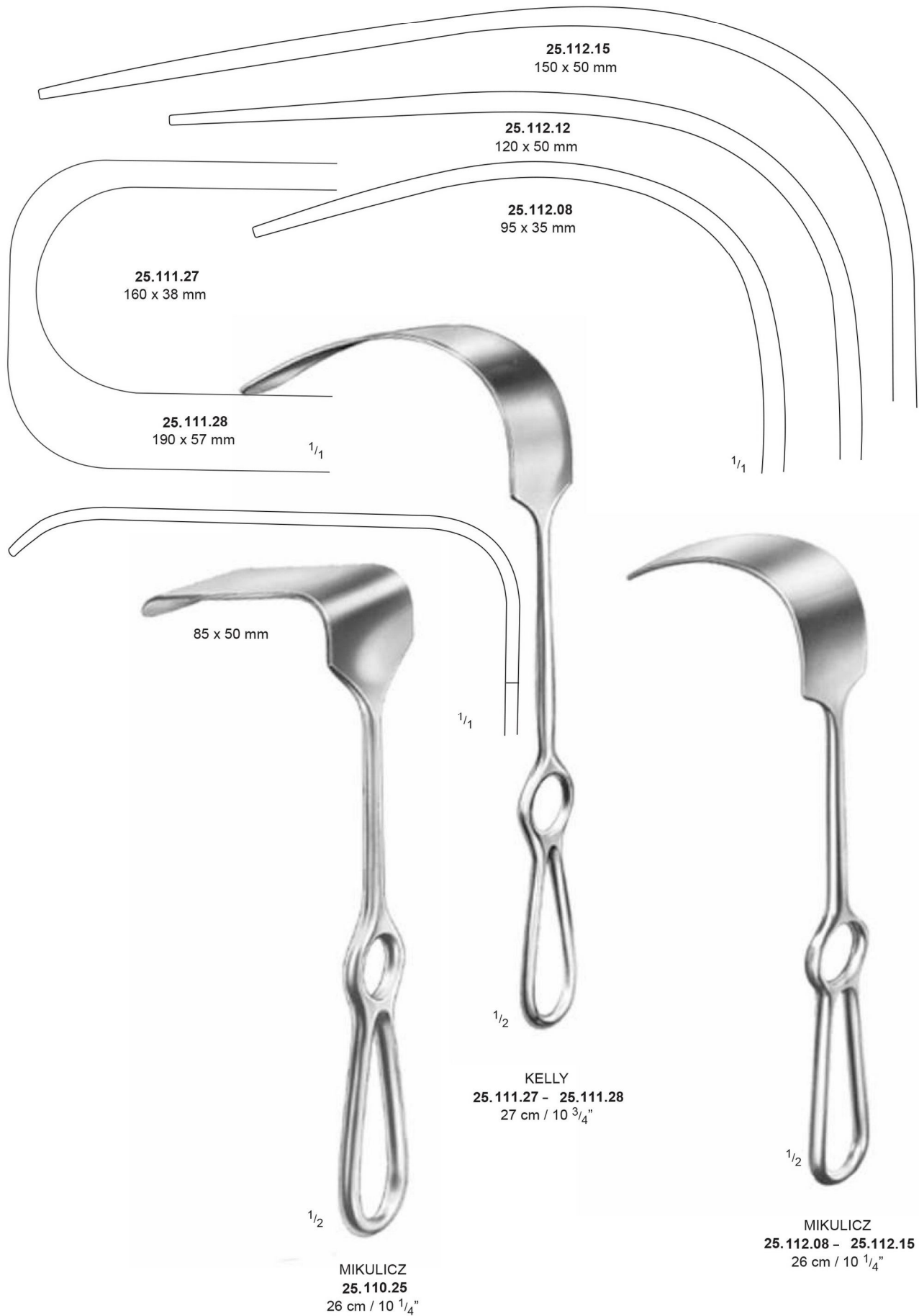

Splanchnic Retractors

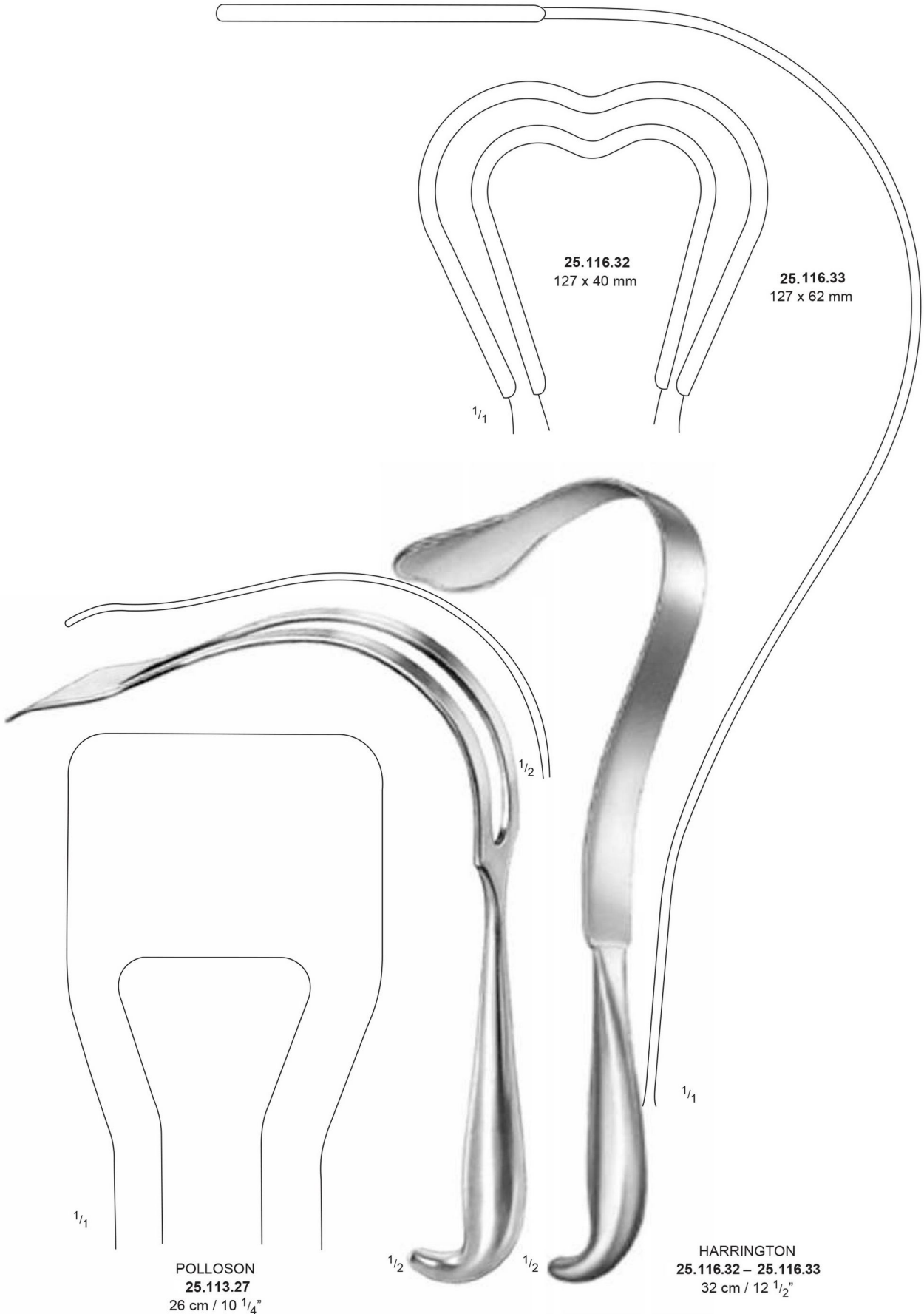

Deaver Retractors



Deaver Retractor



25.118.03
30 cm / 12"

25.118.04
30 cm / 12"

25.118.05 – 75 mm
30 cm / 12"

25.118.06 – 100 mm
30 cm / 12"

Abdominal Retractor, Spatula

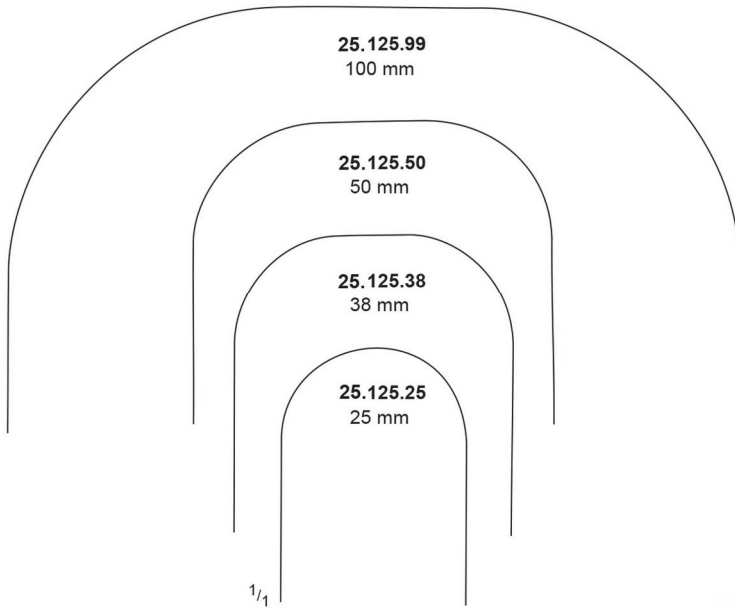

DEAVER
25.125.25 - 25.125.99
32 cm / 12 1/2"

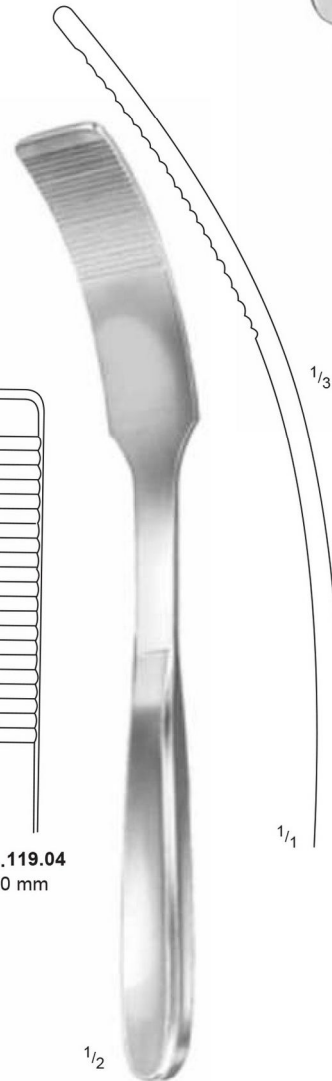
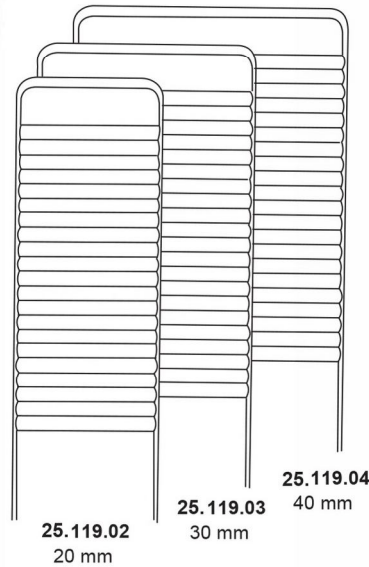

KADER
25.119.02 - 25.119.04
27 cm / 10 3/4"

KOERTE
25.122.30
30 cm / 12"

Self Retaining Retractor

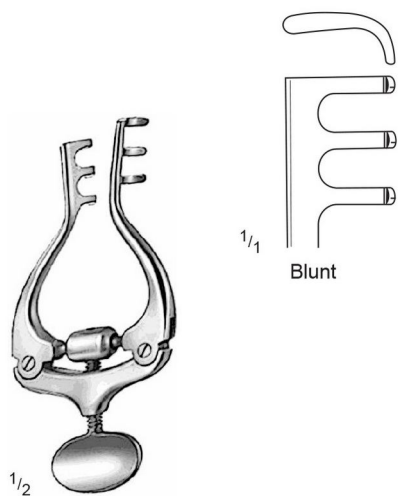

JANSEN
25.05.20
10 cm / 4"
3 x 3 teeth

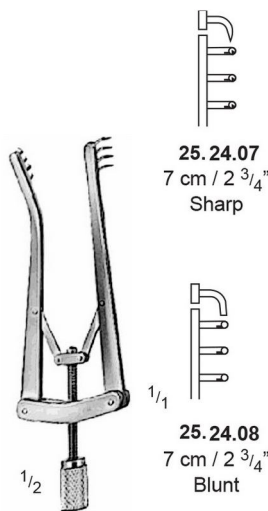

ALM
25.24.07 - 25.25.10
4 X 4 teeth

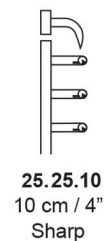

25.25.10
10 cm / 4"
Sharp

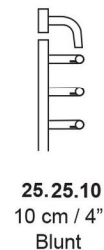

25.25.10
10 cm / 4"
Blunt

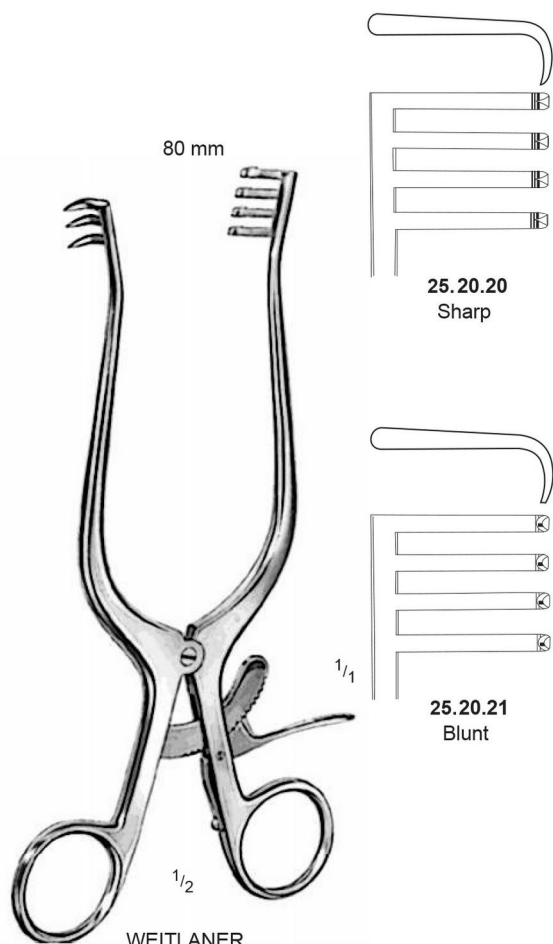

WEITLANER
25.20.20 - 25.20.21
20 cm / 8"
3 x 4 teeth

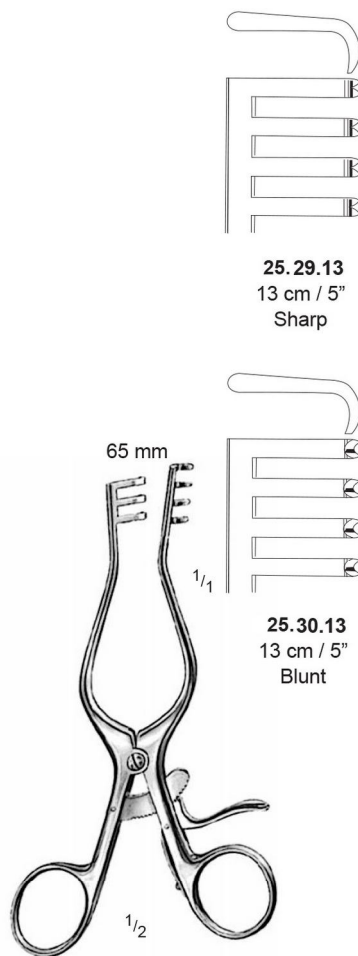

WEITLANER
25.29.13 - 25.30.16
3 x 4 teeth

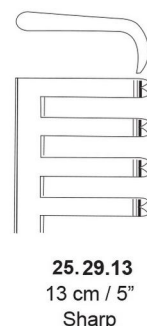

25.29.13
13 cm / 5"
Sharp

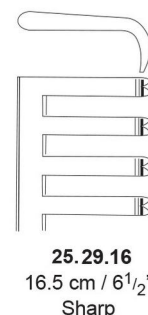

25.29.16
16.5 cm / 6 1/2"
Sharp

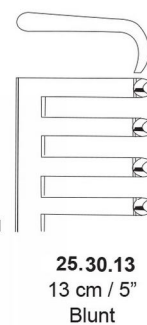

25.30.13
13 cm / 5"
Blunt

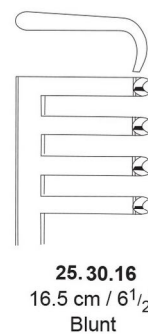

25.30.16
16.5 cm / 6 1/2"
Blunt

Self Retaining Retractors

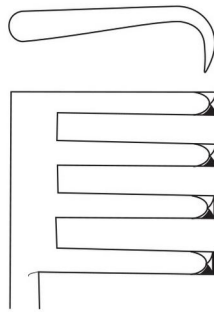

25.38.26
Sharp
3 x 4 teeth

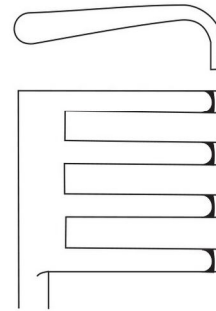

25.38.27
Blunt
3 x 4 teeth



ADSON
25.38.26 25.38.37
26.5 cm / 10 1/2"

1/4

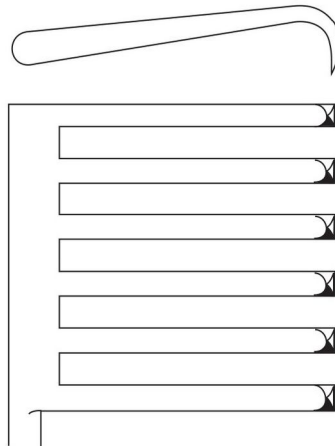

25.38.36
Sharp
6 x 6 teeth

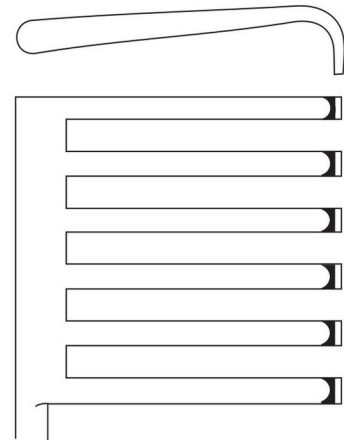

25.38.37
Blunt
6 x 6 teeth

Self Retaining Retractors

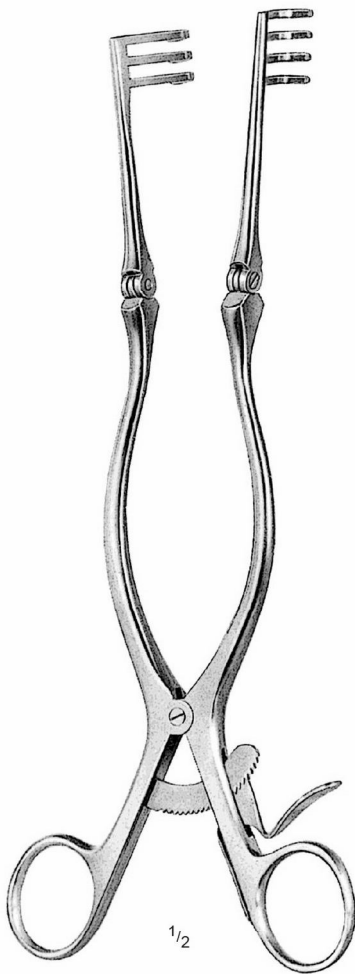

ADSON
25.39.13 25.39.27
3 x 4 teeth

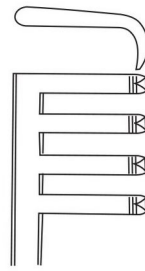

25.39.13
13 cm / 5"

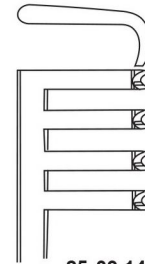

25.39.14
13 cm / 5"

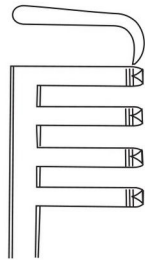

25.39.16
16 cm / 6 1/4"

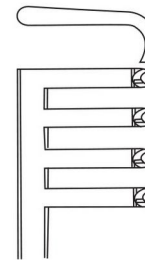

25.39.17
16 cm / 6 1/4"

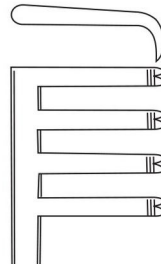

25.39.20
20 cm / 8"

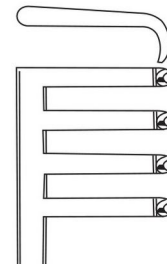

25.39.21
20 cm / 8"

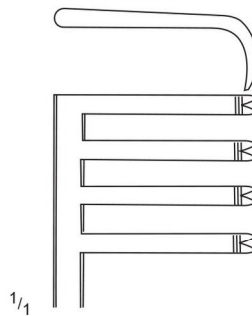

25.39.26
26 cm / 10 1/4"

Sharp

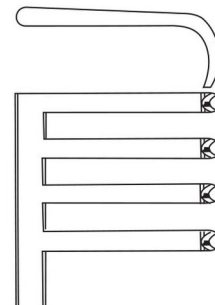

25.39.27
26 cm / 10 1/4"

Blunt

Self Retaining Retractors

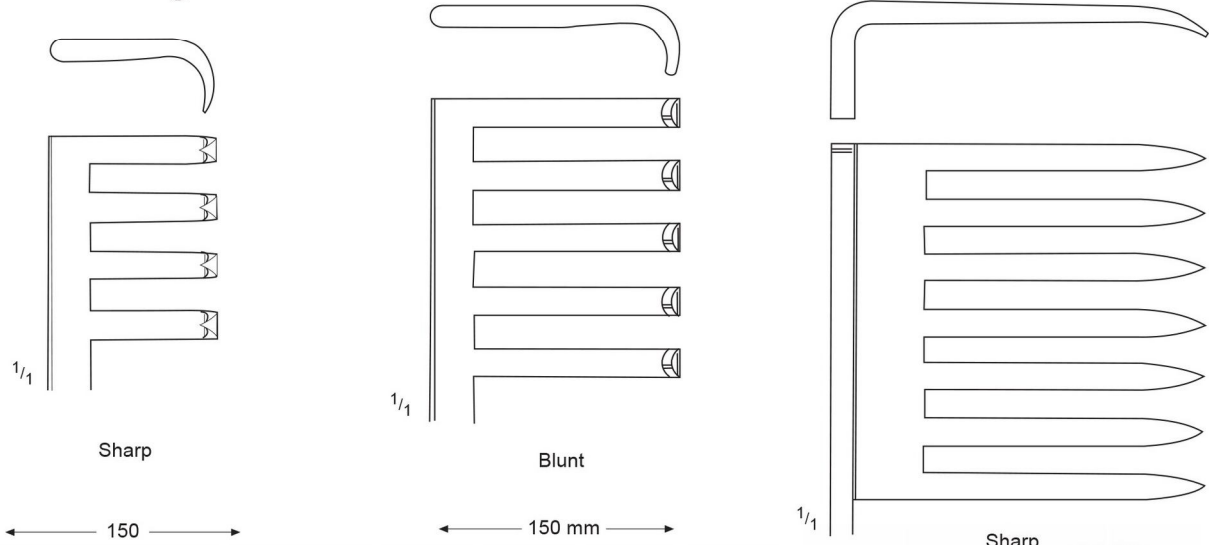

BECKMANN
25.40.31
31 cm / 12 1/4"
4 x 4 teeth

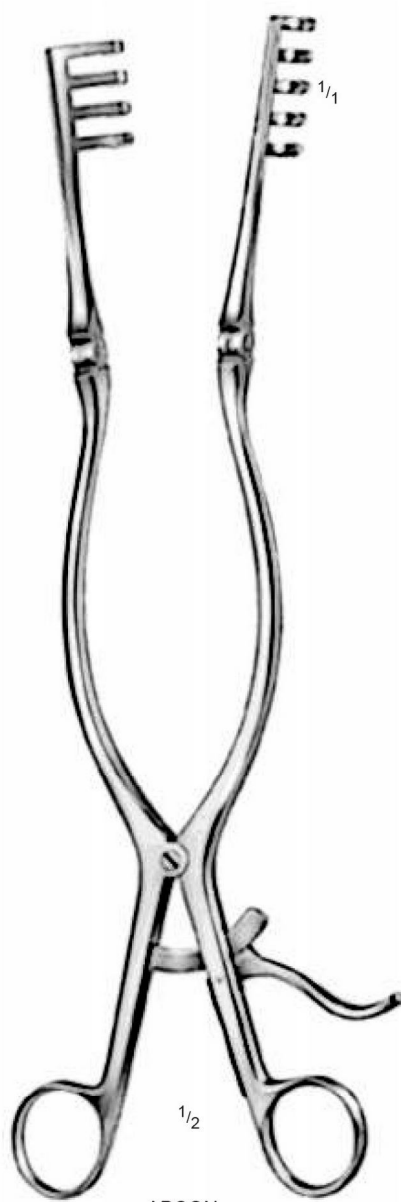

ADSON
25.40.32
32 cm / 12 1/2"
4 x 5 teeth

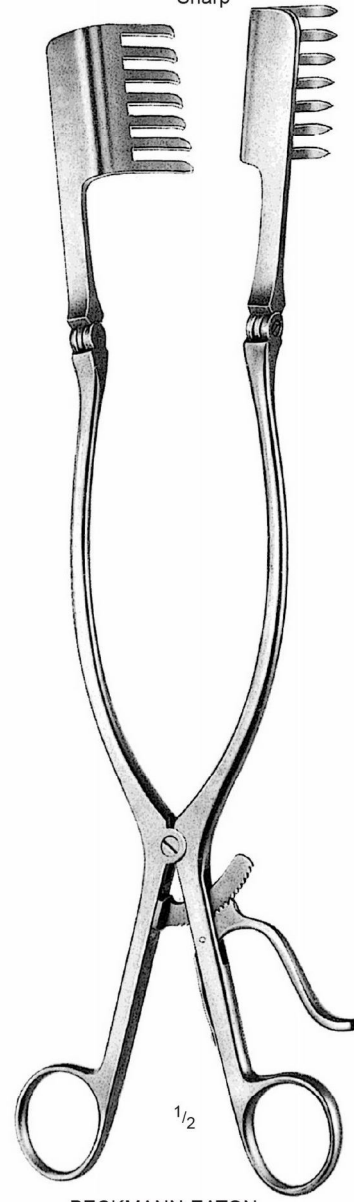

BECKMANN-EATON
25.40.62
32 cm / 12 1/2"
7 x 7 teeth

Self-retaining Retractors



BECKMANN-ADSON
25.40.51 - 25.40.54
31 cm / 12 1/4"
4 x 4 teeth

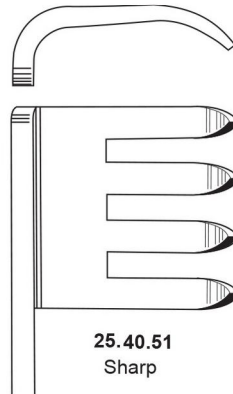

25.40.51
Sharp

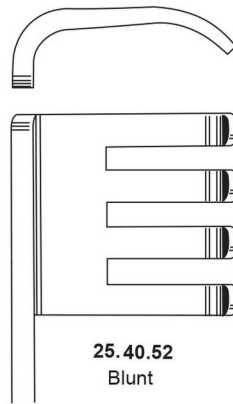

25.40.52
Blunt

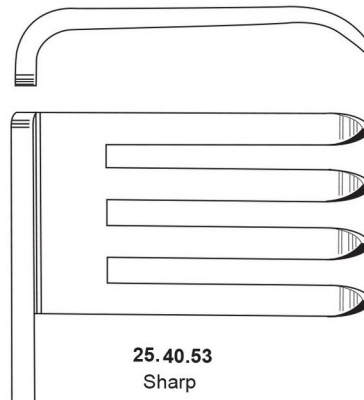

25.40.53
Sharp

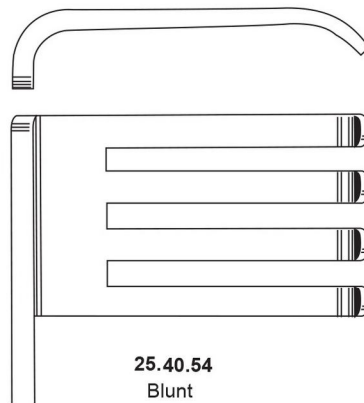

1/1

25.40.54
Blunt

Abdominal Retractors

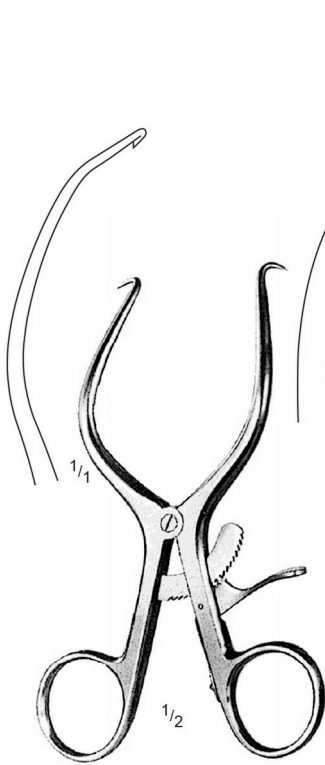

GELPI
25.43.14
14 cm / 5 1/2"

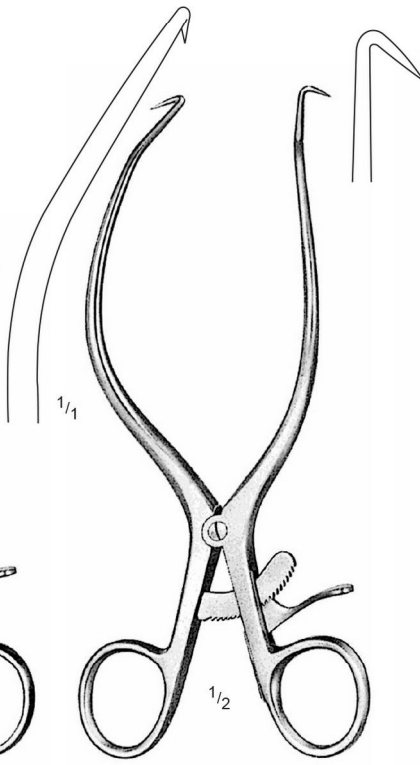

GELPI
25.44.17
17 cm / 6 3/4"

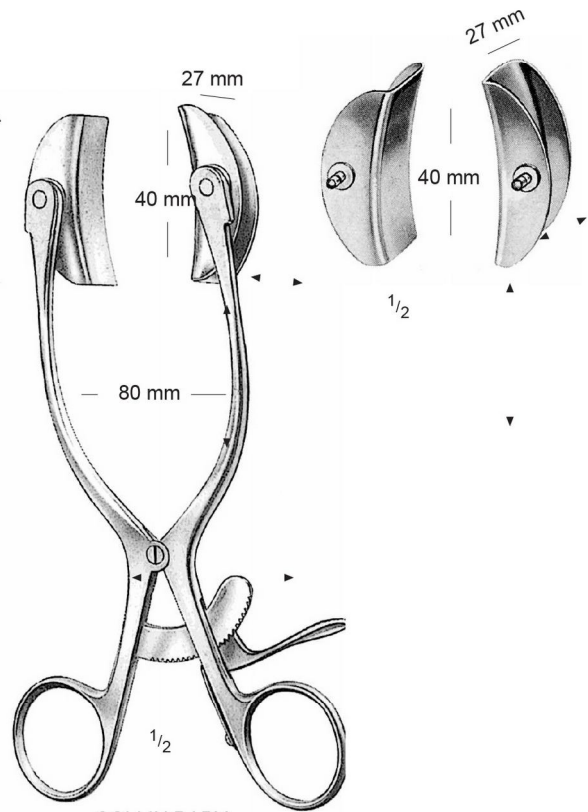

COLLIN BABY
25.48.00
complete with two pair of blades

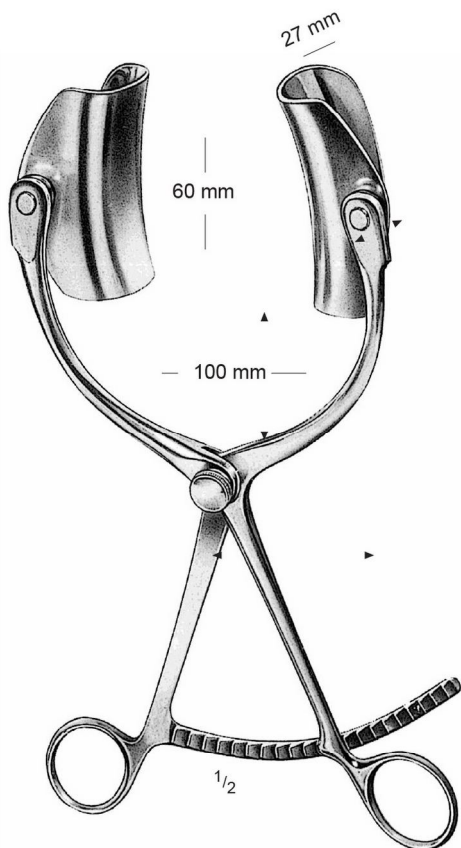

COLLIN
25.48.24
24 cm / 9 1/2"



COLLIN
Lateral Blades Centre Blades
25.54.00 = 38 x 60 mm - 38 x 55 mm
25.54.01 = 38 x 80 mm - 50 x 75 mm

Abdominal Retractors

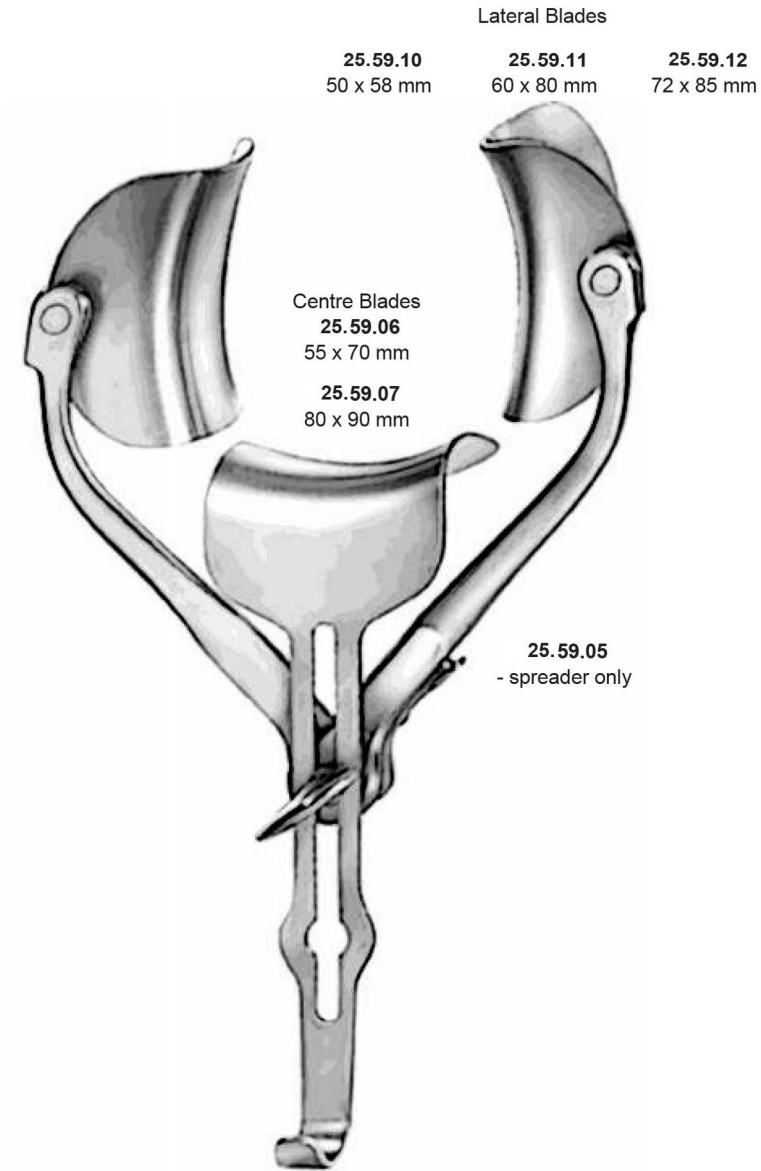

Lateral Blades

25.59.10
50 x 58 mm

25.59.11
60 x 80 mm

25.59.12
72 x 85 mm

Centre Blades
25.59.06
55 x 70 mm
25.59.07
80 x 90 mm

25.59.05
- spreader only

RICARD
25.59.00 – 28 cm / 11"
25.59.01 – 30 cm / 12"
complete

Abdominal Retractors

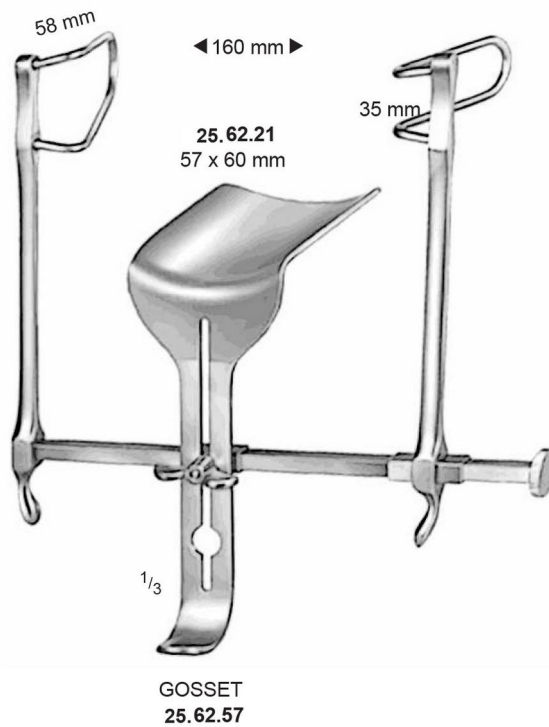
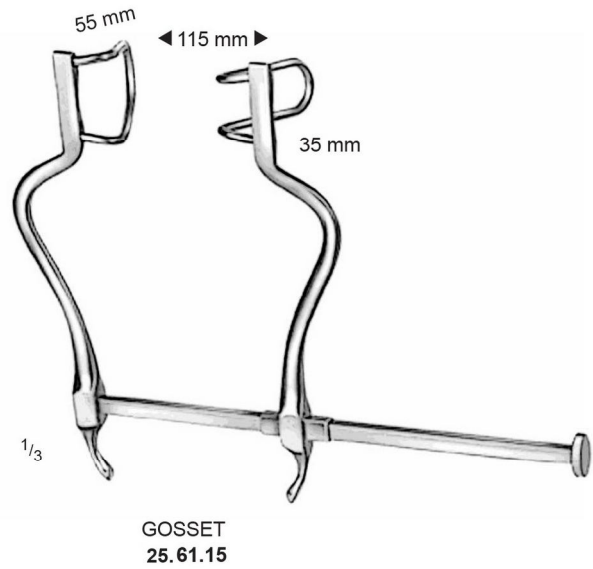
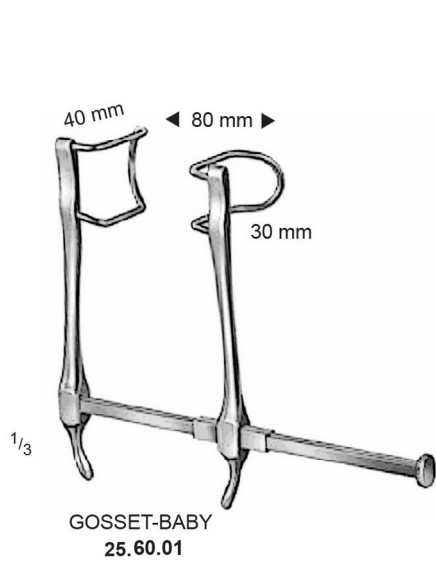

Abdominal Retractors

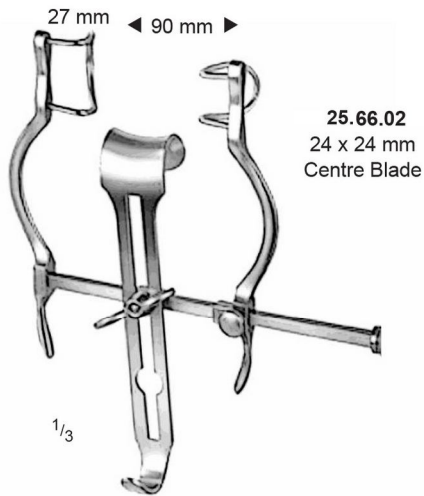

BALFOUR BABY
25.66.01

25.66.02
24 x 24 mm
Centre Blade

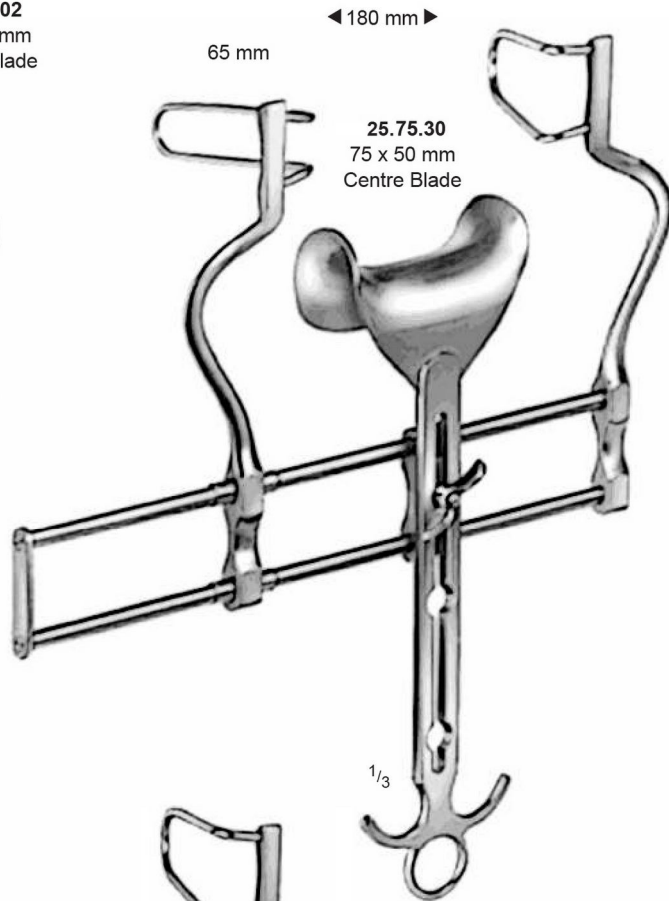

25.75.30
75 x 50 mm
Centre Blade

BALFOUR
25.69.10

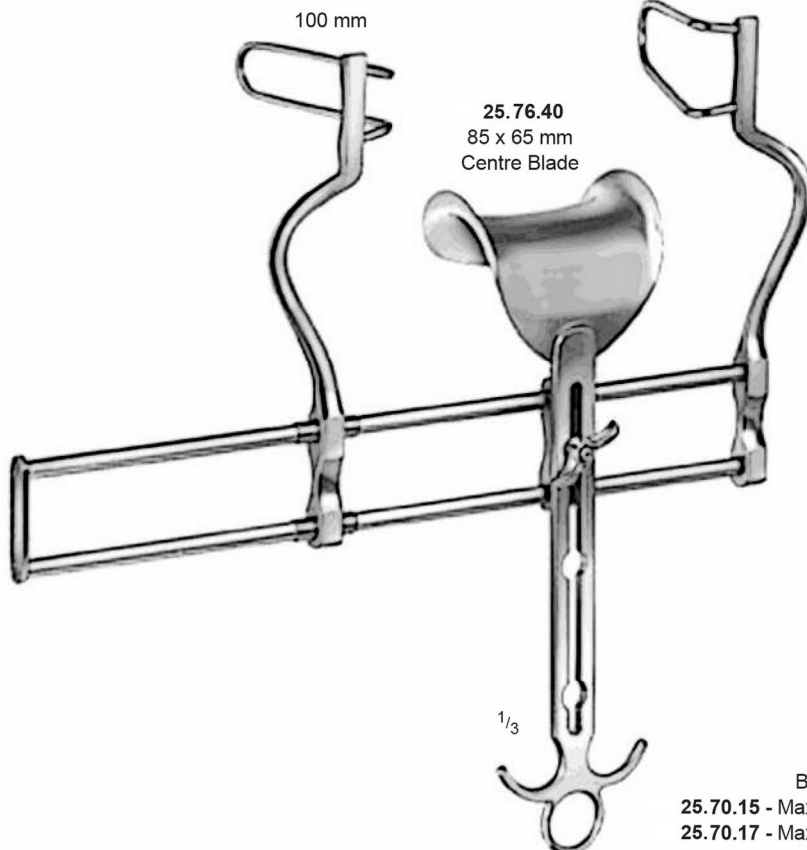

25.76.40
85 x 65 mm
Centre Blade

BALFOUR
25.70.15 - Maximum Spread 180 mm
25.70.17 - Maximum Spread 250 mm

Abdominal Retractors

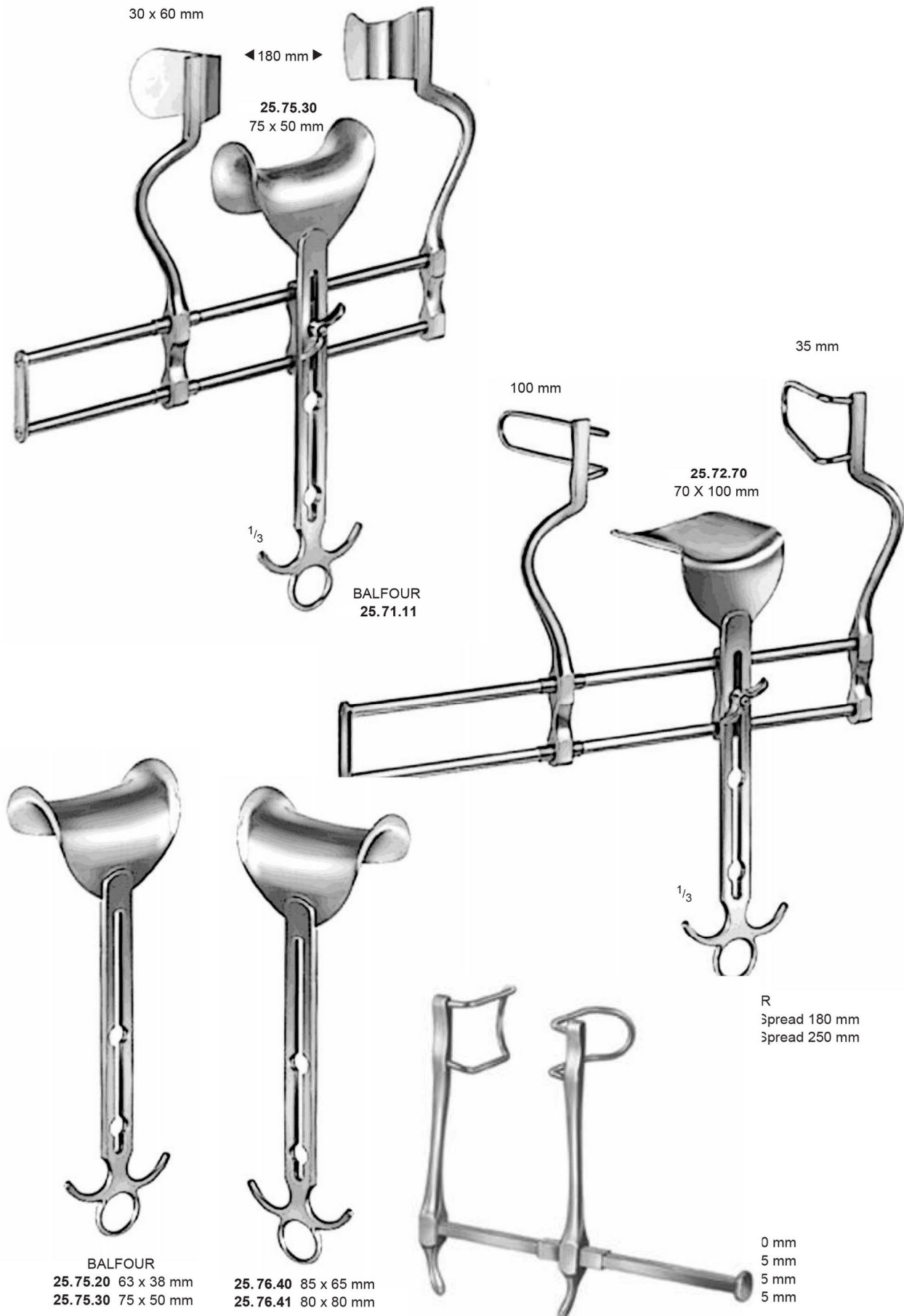

Abdominal Retractors

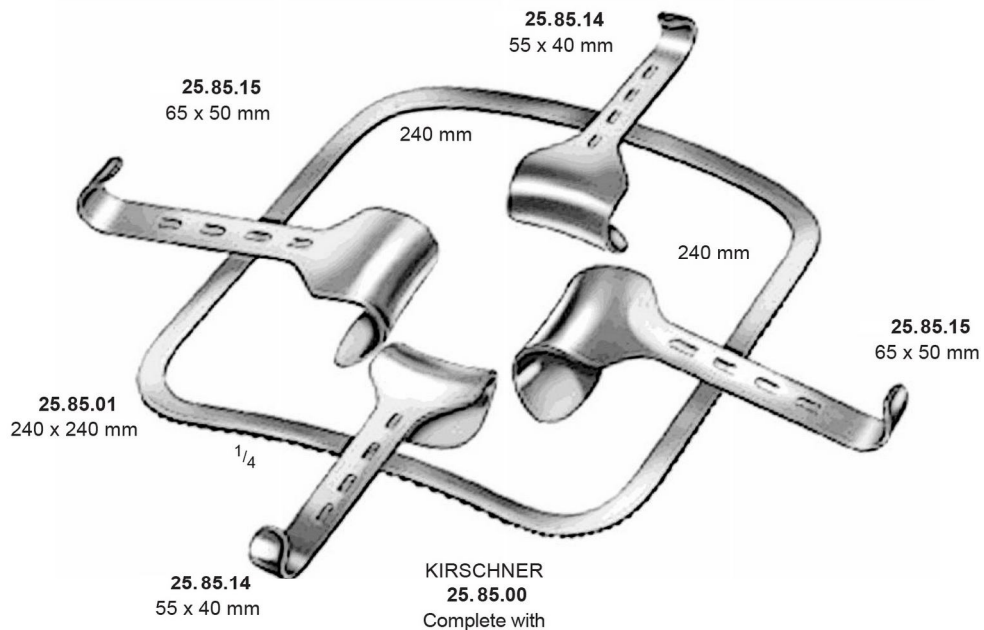

- KIRSCHNER
25.85.00**
Complete with
- 25.85.01** 1 Frame rigid - 240 x 240 mm
 - 25.85.15** 2 Hook on retractors, 65 x 50 mm
 - 25.85.14** 2 Hook on Retractors, 55 x 40 mm

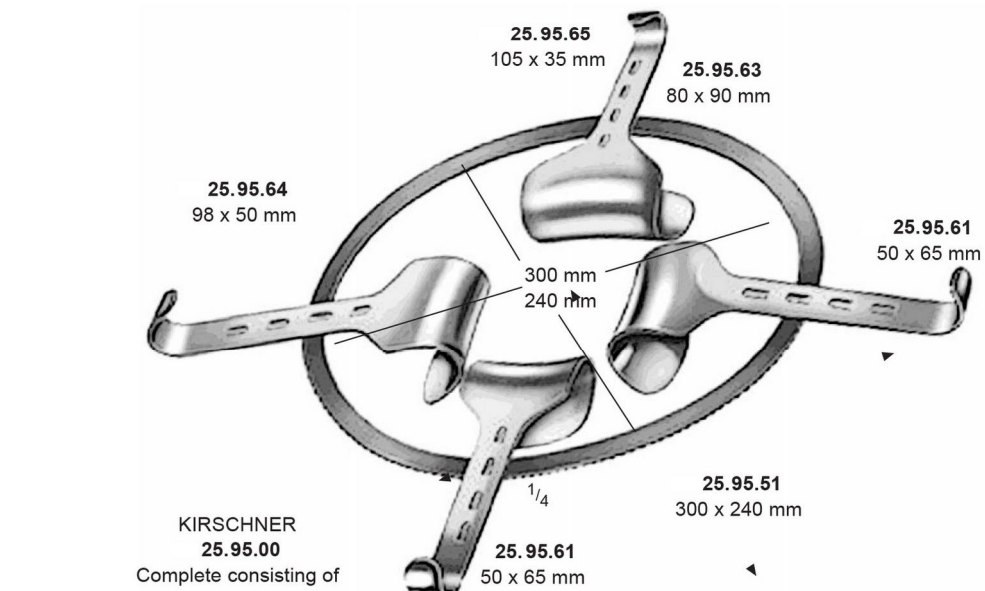

- KIRSCHNER
25.95.00**
Complete consisting of
- 25.95.51** 1 Frame, 300 x 240 mm
 - 25.95.61** 3 hook-on retractors, 50 x 65 mm
 - 25.95.63** 1 retractor, 80 x 90 mm
 - 25.95.64** 1 retractor, 98 x 50 mm
 - 25.95.65** 1 retractor, 105 x 35 mm