

**Neurosurgery**  
**Neurocirurgia**  
**Neuro-Chirurgie**

**Tel# 0092-52-4260785**

**Fax# 0092-52-4266804**

**Email. [Info@benison.com.pk](mailto:Info@benison.com.pk)**

**Intervertebral Disc Rongeurs**

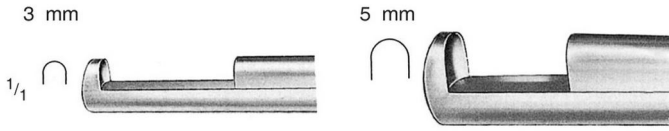

	Length of Shaft	
	15 cm / 6"	20 cm / 8"
Jaws 3 mm wide	<b>37.01.03</b>	<b>37.02.03</b>
Jaws 5 mm wide	<b>37.01.05</b>	<b>37.02.05</b>

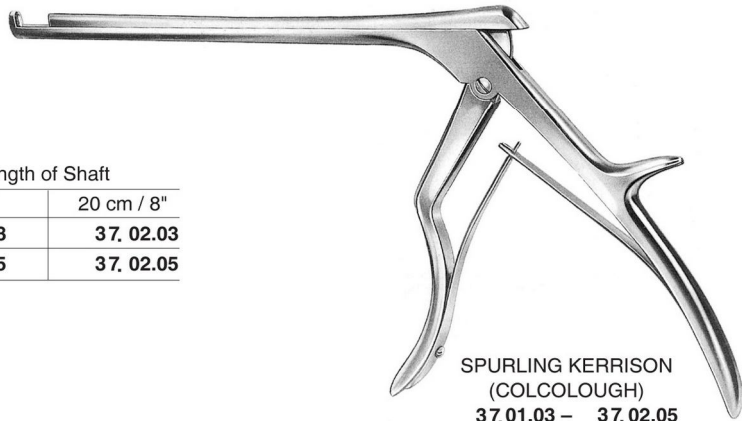

SPURLING KERRISON  
(COLCOLOUGH)  
37.01.03 – 37.02.05

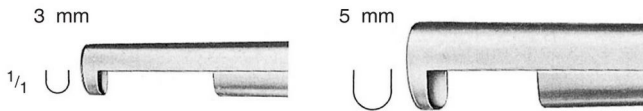

	Length of Shaft	
	15 cm / 6"	20 cm / 8"
Jaws 3 mm wide	<b>37.01.13</b>	<b>37.02.13</b>
Jaws 5 mm wide	<b>37.01.15</b>	<b>37.02.15</b>

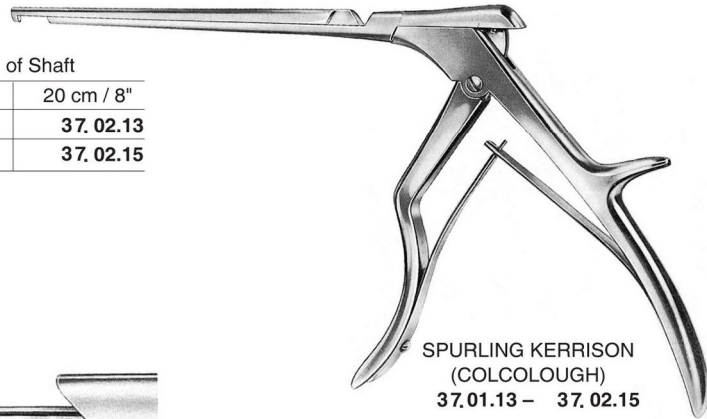

SPURLING KERRISON  
(COLCOLOUGH)  
37.01.13 – 37.02.15

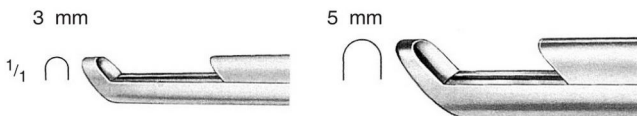

	Length of Shaft	
	15 cm / 6"	20 cm / 8"
Jaws 3 mm wide	<b>37.01.23</b>	<b>37.02.23</b>
Jaws 5 mm wide	<b>37.01.25</b>	<b>37.02.25</b>







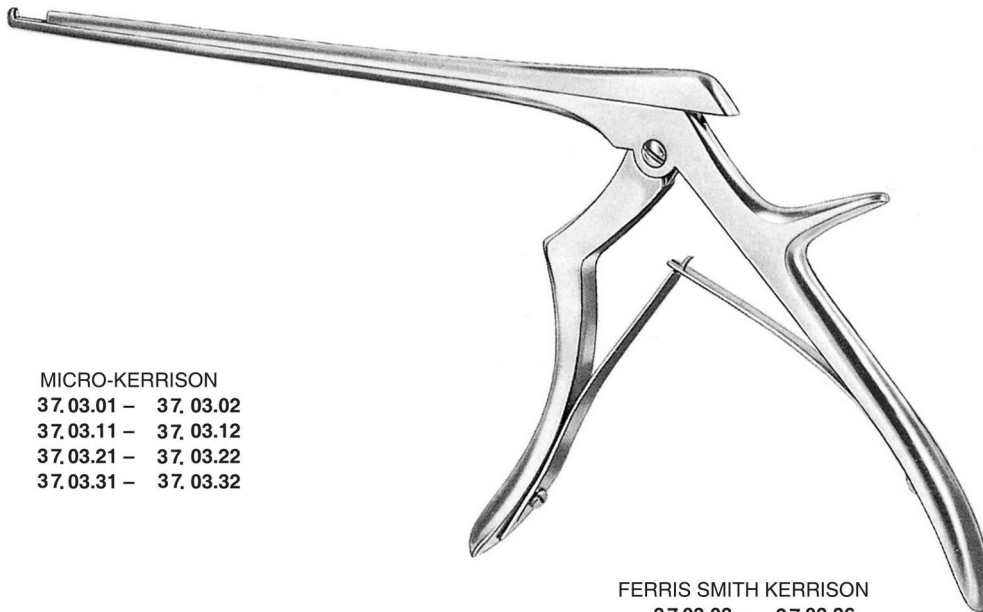



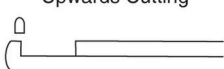
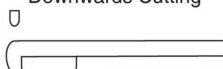
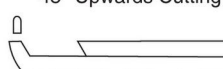
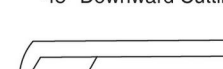
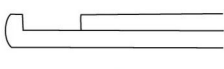
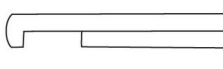
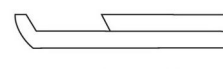
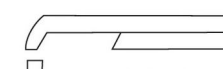

SPURLING KERRISON  
(COLCOLOUGH)  
37.01.23 – 37.02.25

**Intervertebral Disc Rongeurs**

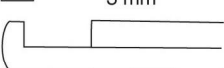
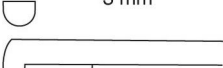

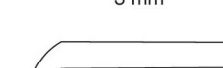
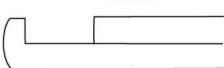
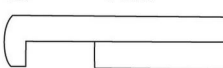
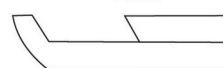
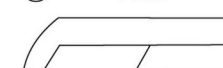
MICRO-KERRISON  
37.03.01 – 37.03.02  
37.03.11 – 37.03.12  
37.03.21 – 37.03.22  
37.03.31 – 37.03.32

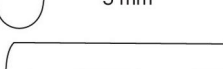
FERRIS SMITH KERRISON  
37.03.03 – 37.03.36

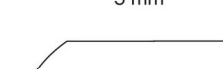

Upwards Cutting	Downwards Cutting	45° Upwards Cutting	45° Downward Cutting
 <b>37.03.01</b> 1 mm	 <b>37.03.11</b> 1 mm	 <b>37.03.21</b> 1 mm	 <b>37.03.31</b> 1 mm
 <b>37.03.02</b> 2 mm	 <b>37.03.12</b> 2 mm	 <b>37.03.22</b> 2 mm	 <b>37.03.32</b> 2 mm
 <b>37.03.03</b> 3 mm	 <b>37.03.13</b> 3 mm	 <b>37.03.23</b> 3 mm	 <b>37.03.33</b> 3 mm
 <b>37.03.04</b> 4 mm	 <b>37.03.14</b> 4 mm	 <b>37.03.24</b> 4 mm	 <b>37.03.34</b> 4 mm
 <b>37.03.05</b> 5 mm	 <b>37.03.15</b> 5 mm	 <b>37.03.25</b> 5 mm	 <b>37.03.35</b> 5 mm
 <b>37.03.06</b> 6 mm	 <b>37.03.16</b> 6 mm	 <b>37.03.26</b> 6 mm	 <b>37.03.36</b> 6 mm

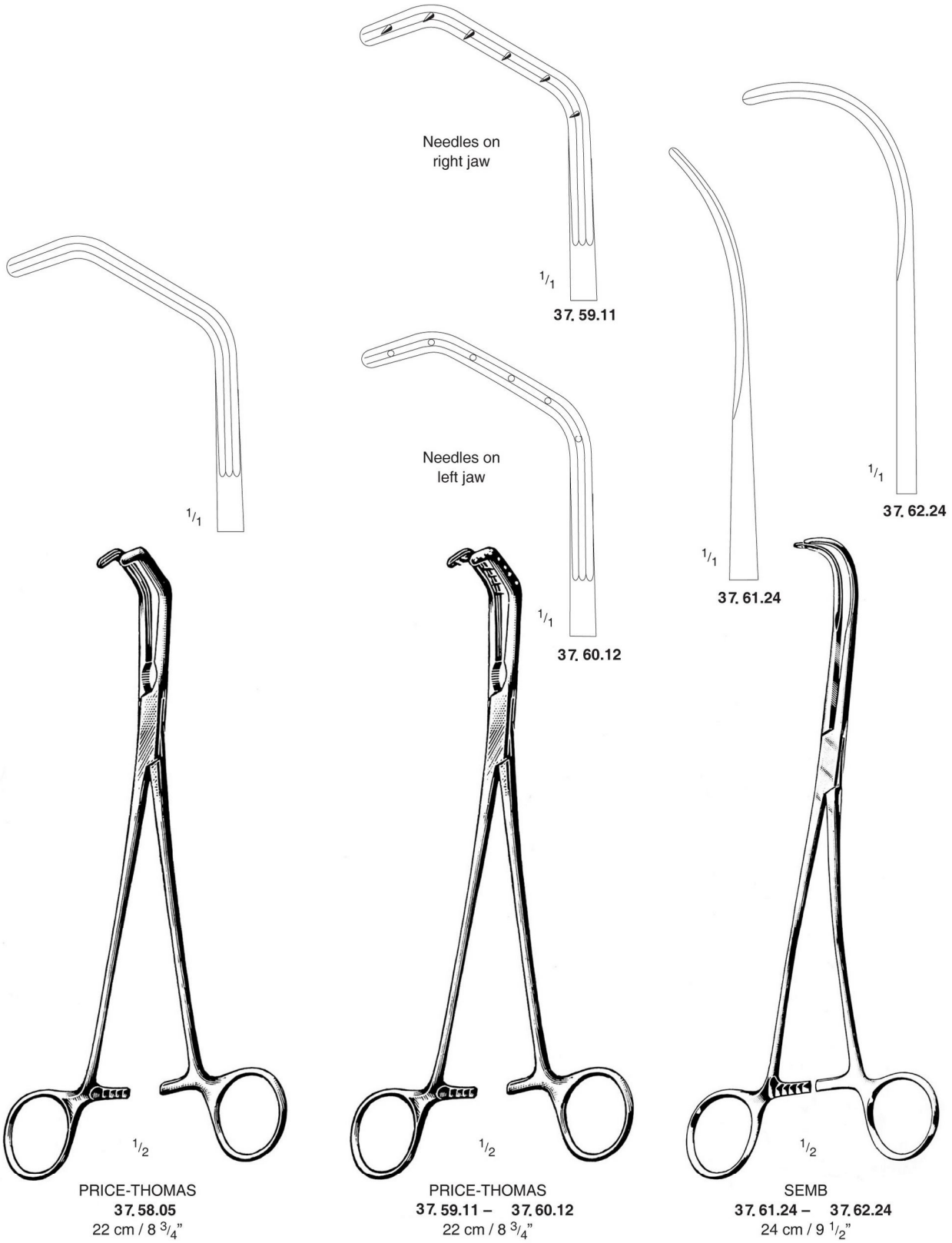
**Bronchus Forceps**

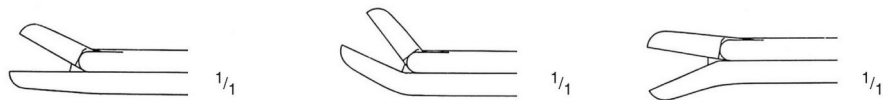
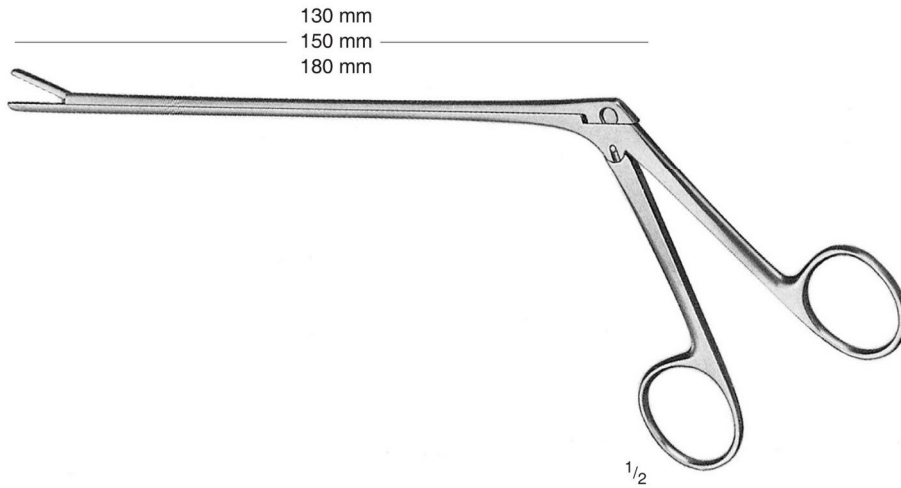

### Laminectomy Rongeurs



	Shaft Size	Straight	Upward	Downwards
<b>CUSHING</b> 2 x 10 mm 	13.0 cm / 5"	<b>37.04.02</b>	<b>37.04.32</b>	<b>37.04.62</b>
	15.0 cm / 6"	<b>37.04.15</b>	<b>37.04.45</b>	<b>37.04.75</b>
	18.0 cm / 7"	<b>37.04.22</b>	<b>37.04.52</b>	<b>37.04.82</b>
<b>LOVE-GRUENWALD</b> 3 x 10 mm 	13.0 cm / 5"	<b>37.08.03</b>	<b>37.08.33</b>	<b>37.08.63</b>
	15.0 cm / 6"	<b>37.08.15</b>	<b>37.08.45</b>	<b>37.08.75</b>
	18.0 cm / 7"	<b>37.08.23</b>	<b>37.08.53</b>	<b>37.08.83</b>
<b>SPURLING</b> 4 x 10 mm 	13.0 cm / 5"	<b>37.11.83</b>	<b>37.11.93</b>	<b>37.11.94</b>
	15.0 cm / 6"	<b>37.11.85</b>	<b>37.11.95</b>	<b>37.11.96</b>
	18.0 cm / 7"	<b>37.11.88</b>	<b>37.11.98</b>	<b>37.11.99</b>

**Laminectomy Rongeurs**

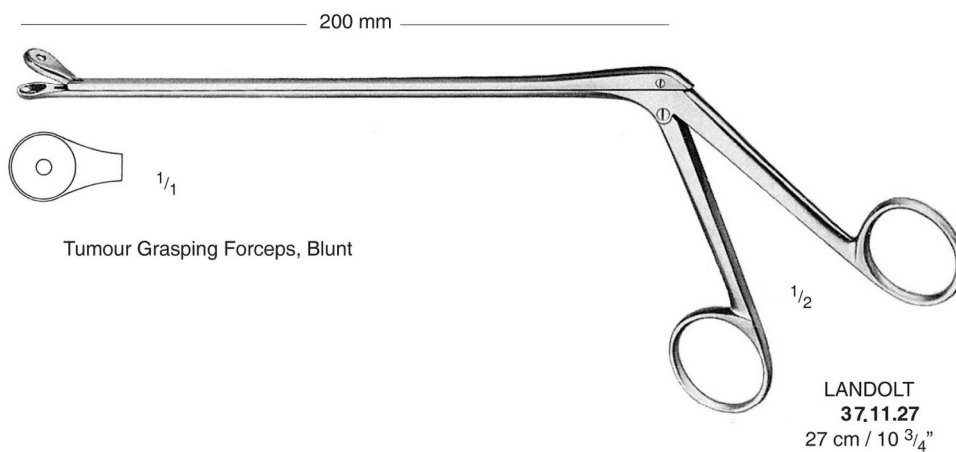
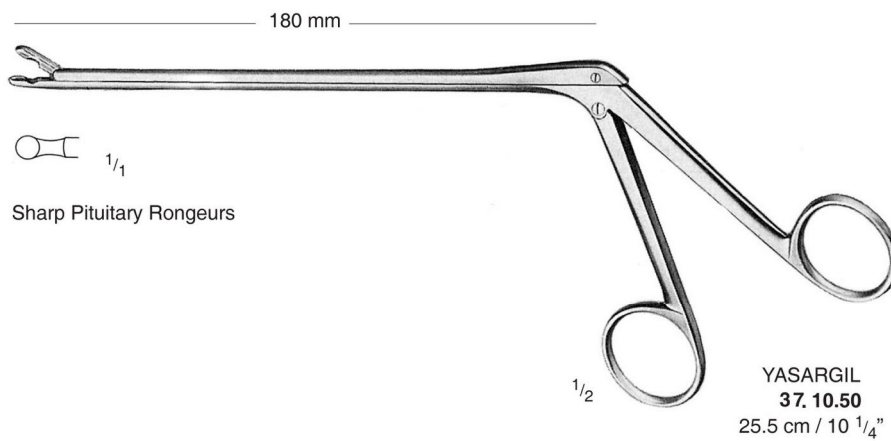
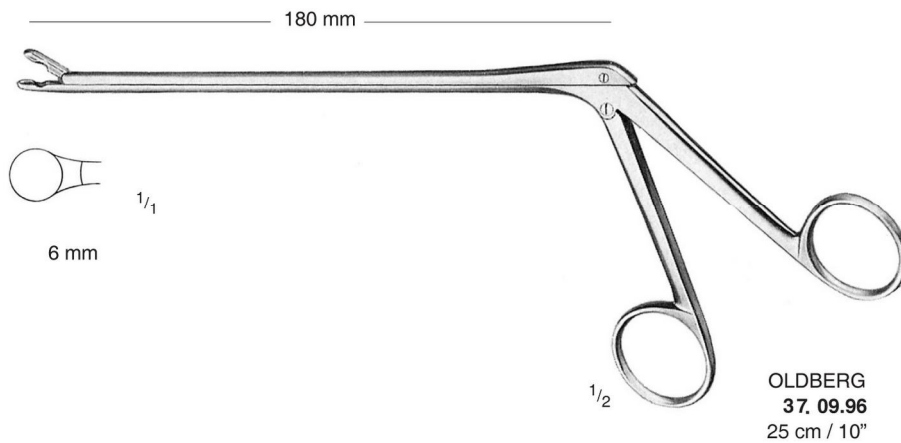

**Brain Spatulas, Dura Dissectors**

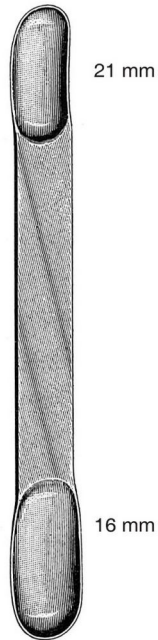

**CUSHING**  
37.15.17 – 17 cm / 6 3/4"  
37.15.20 – 20 cm / 8"

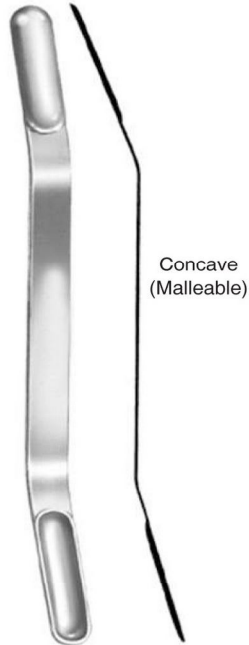

**OILVECRONA**  
18 cm (7 1/8")  
37.16.09 – 7 + 9 mm  
37.16.13 – 11 + 13 mm  
37.16.18 – 15 + 18 mm  
37.16.22 – 18 + 22 mm

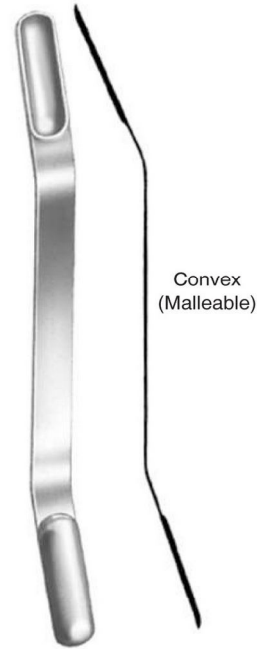

**OILVECRONA**  
18 cm (7 1/8")  
37.17.39 – 7 + 9 mm  
37.17.43 – 11 + 13 mm  
37.17.48 – 15 + 18 mm  
37.17.52 – 18 + 22 mm



**FRAZIER**  
37.18.01  
15 cm / 6"



**HOEN**  
37.18.02  
15 cm / 6"



**HOEN**  
37.18.03  
15 cm / 6"



**DAVIS**  
37.41.24  
24.5 cm / 9 3/4"

**Dura Dissectors**

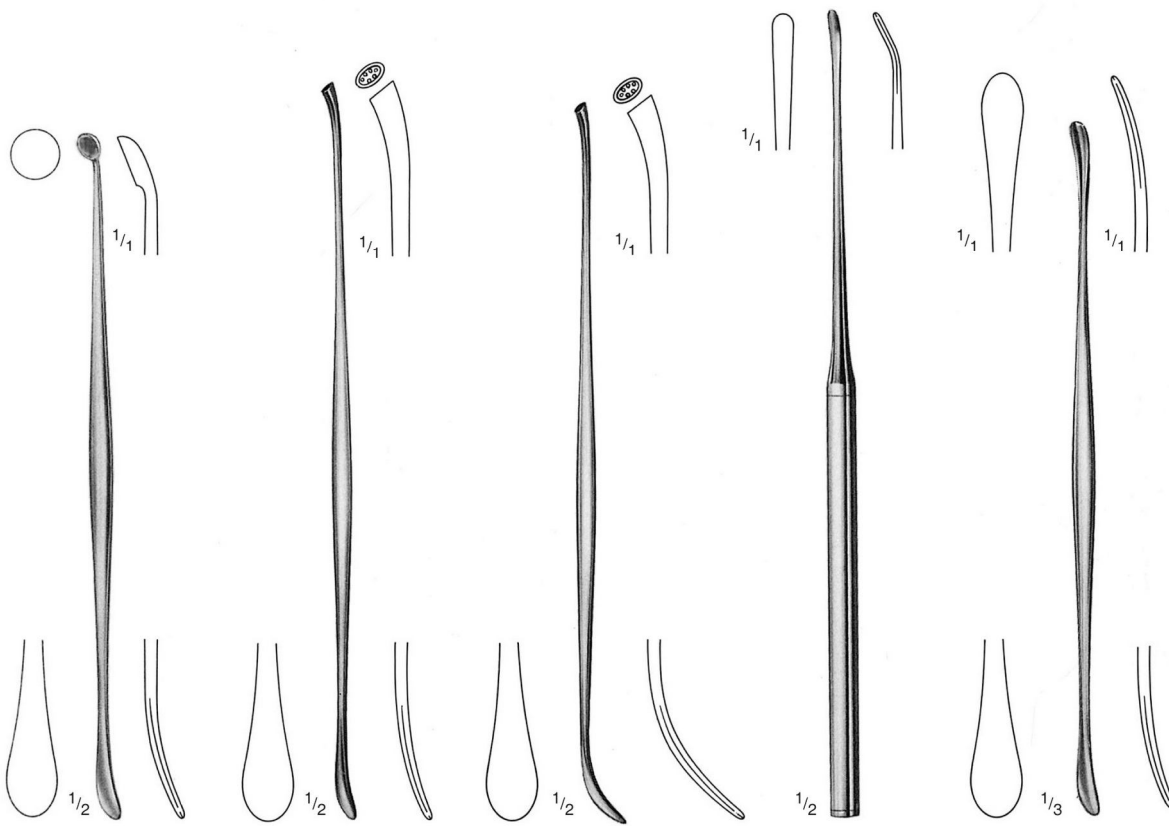

PENFIELD  
37.37.51  
Fig. 1  
17.5 cm / 7"

PENFIELD  
37.37.52  
Fig. 2  
19.5 cm / 7 3/4"

PENFIELD  
37.37.53  
Fig. 3  
19.5 cm / 7 3/4"

PENFIELD  
37.38.54  
Fig. 4  
21.5 cm / 8 1/2"

PENFIELD  
37.39.55  
Fig. 5  
29 cm / 11 1/2"



**Nerve Root Retractors**



SCOVILLE  
37.42.50  
23 cm / 9"

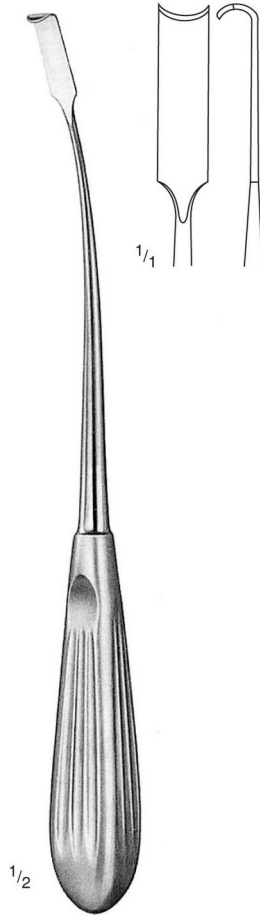

HOLSHER  
37.42.51  
24 cm / 9 1/2"

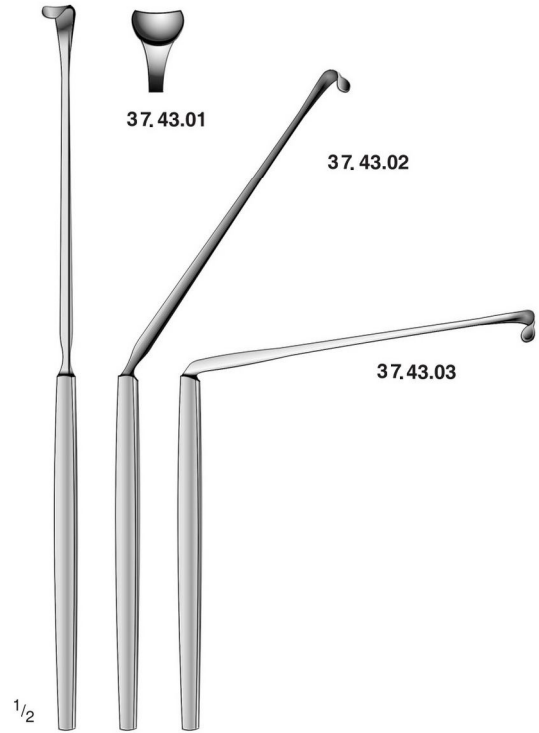

LOVE  
37.43.01 - 37.43.03

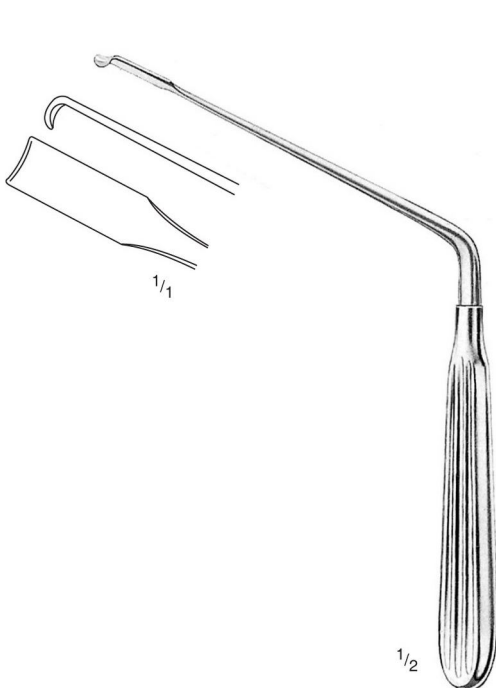

SCOVILLE  
37.43.51  
23 cm / 9"

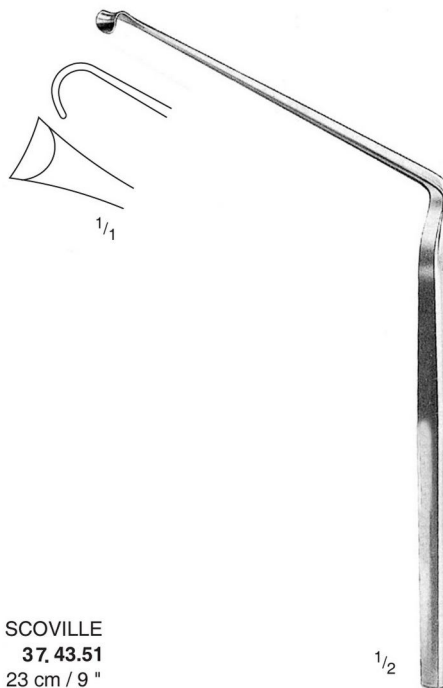

PROFESSIONAL  
37.44.52  
21 cm / 8 1/4"

Lamina Spreaders



CLOWARD  
37.49.75  
16 cm / 6 1/4"

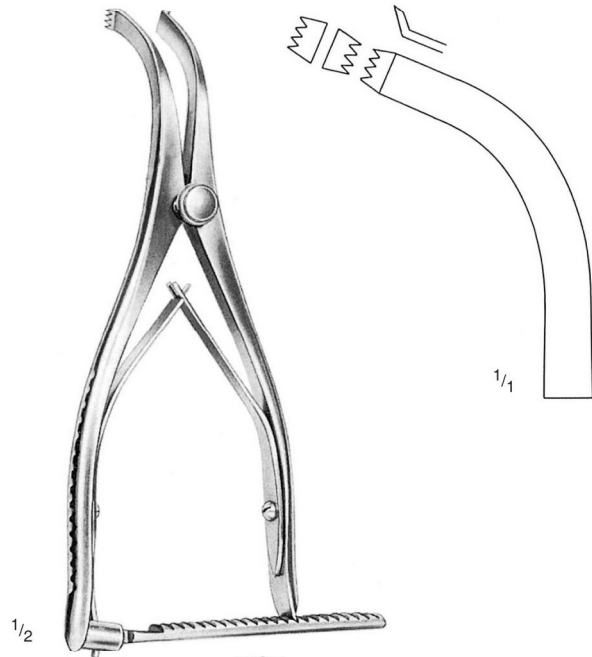

INGE  
37.50.05  
16 cm / 6 1/4"

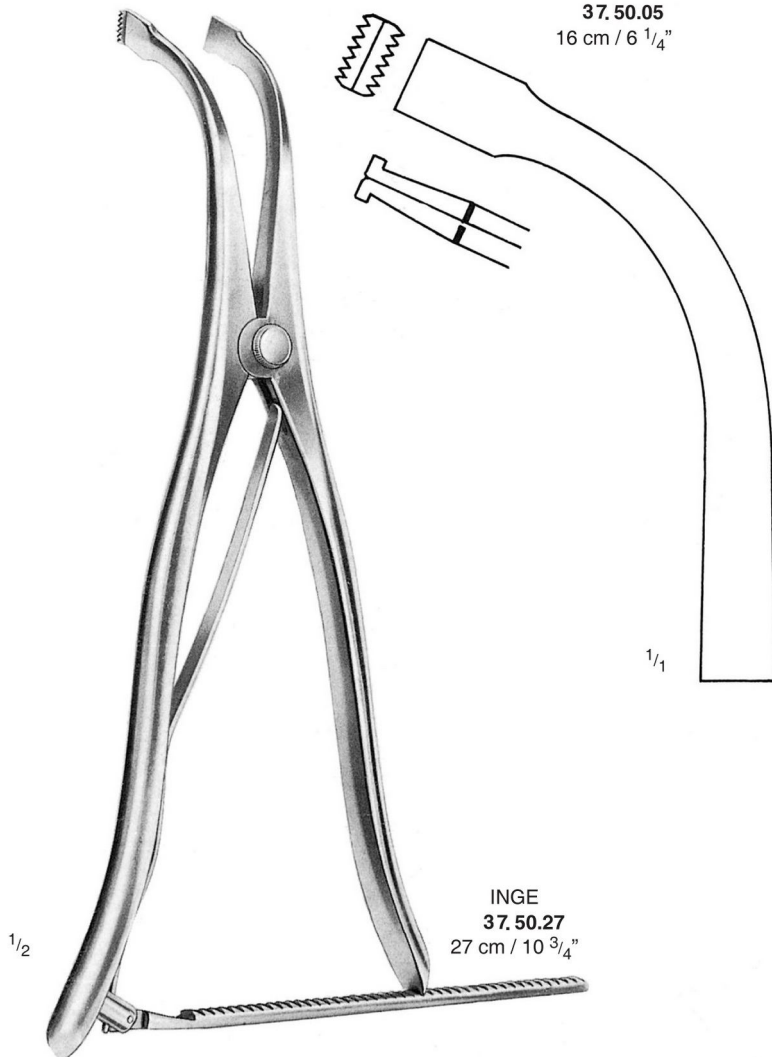

INGE  
37.50.27  
27 cm / 10 3/4"

Traction Tongs, Cranial Drills

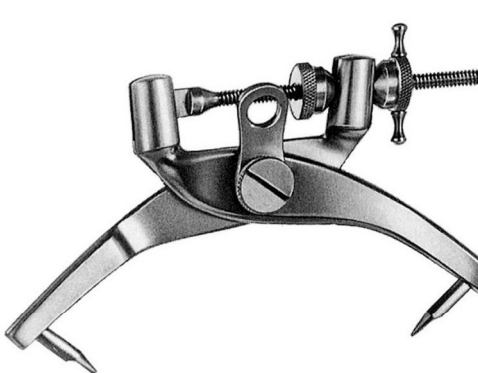

CRUTCHFIELD  
37.52.01

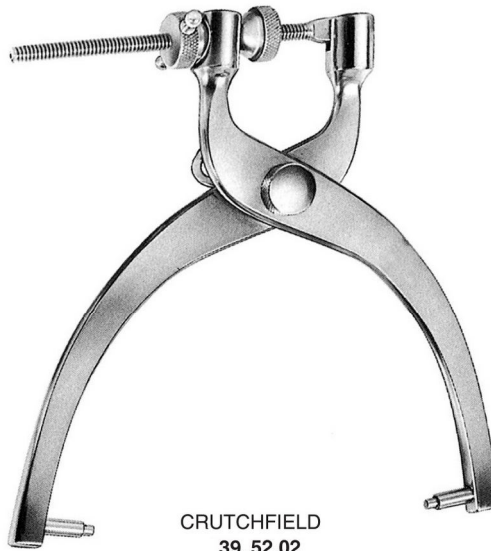

CRUTCHFIELD  
39.52.02



37.52.04  
ø 3.5 mm



37.52.05  
ø 5 mm

EXTENSION PIECE  
ONLY  
37.53.05



37.54.09  
ø 9 mm



37.54.14  
ø 14 mm



37.55.16  
ø 16 mm



37.55.22  
ø 22 mm



BRACE ONLY  
37.54.03

HUDSON  
Cranial Drill  
Complete with 4  
burs No.,  
37.54.09  
37.54.14  
37.55.16  
37.55.22



CUSHING  
37.56.34  
ø 13 mm



McKENZIE  
37.57.43  
ø 13 mm



D'ERRICO  
37.58.76  
ø 16 mm

**Brain Retractors, Spatulas**

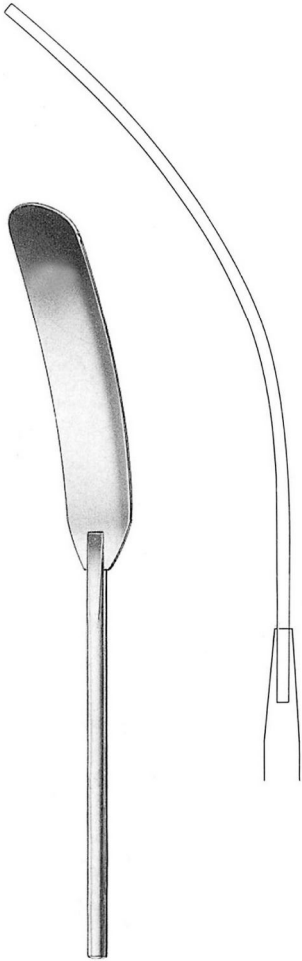

HEIFETZ  
20 cm / 8"  
37.70.68 8 mm  
37.70.71 11 mm  
37.70.74 14 mm  
37.70.77 17 mm  
37.70.80 20 mm

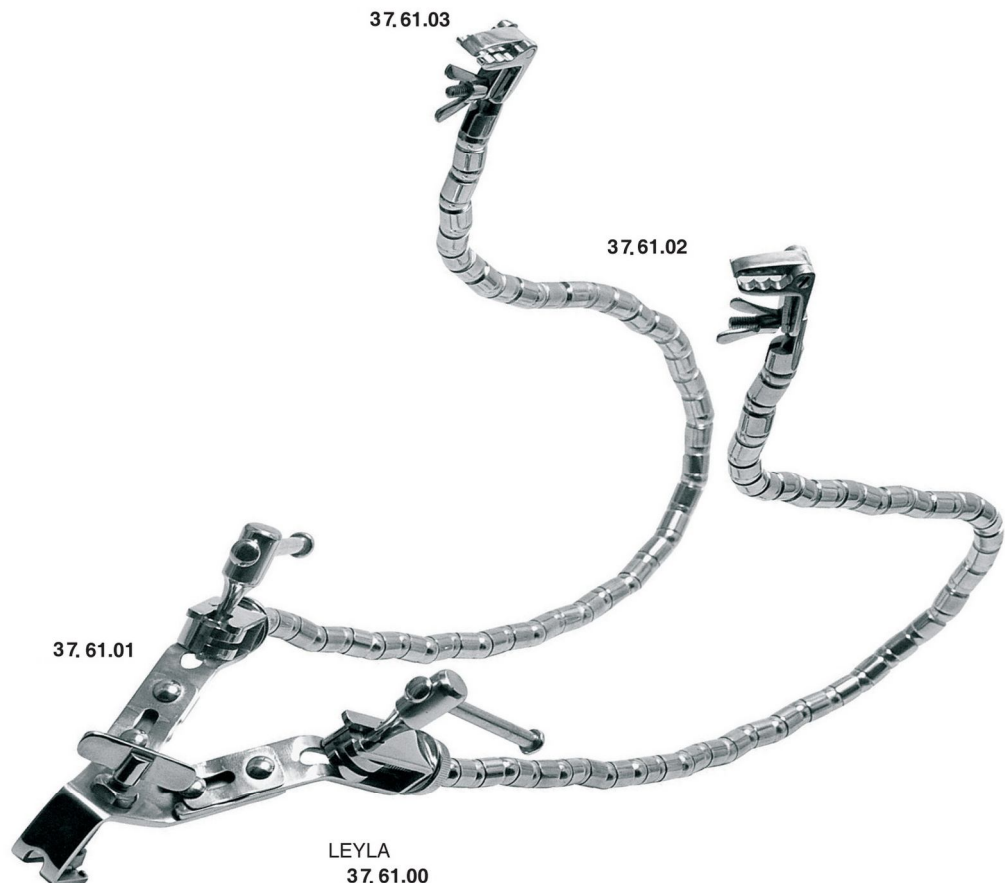

LEYLA  
37.61.00  
Complete with two flexible arms no. 37.61.02,  
one fixation base no 37.61.01 and two clamps  
No. 37.61.03 for holding brain spatulas