



Nasal Instruments
Instrumentais Nasais
Instrumentes Nasaux

Tel# 0092-52-4260785

Fax# 0092-52-4266804

Email. Info@benison.com.pk

Sinus Wash Canulae, Nasal Snares

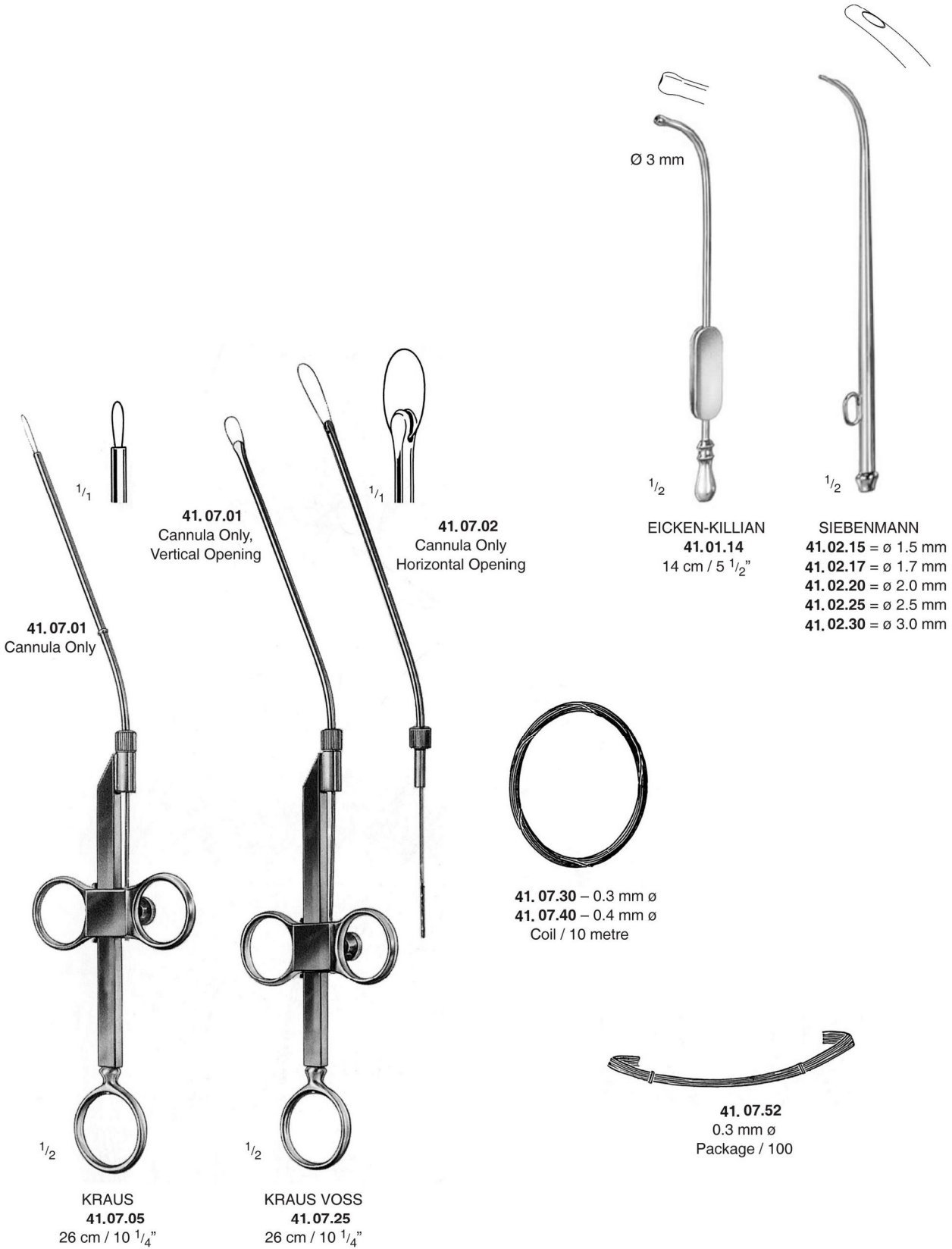

Dressing and Polypus Forceps

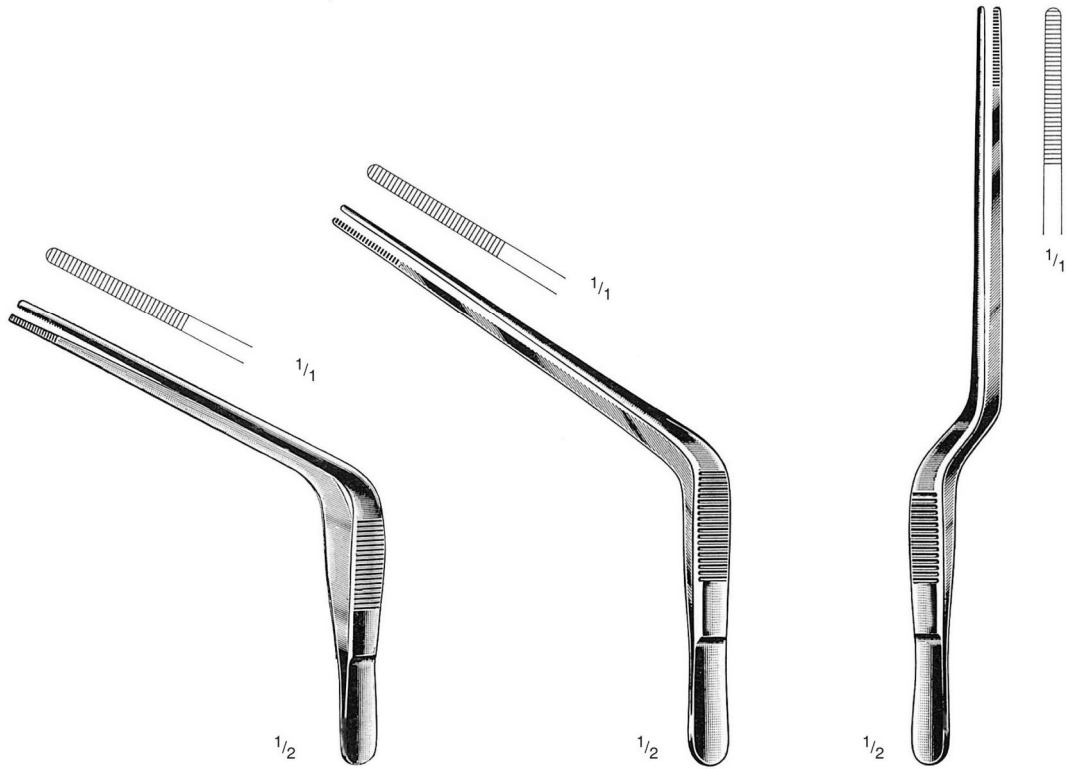

TROELTSCH
41.01.15
15 cm / 6"

TROELTSCH
41.02.18
18 cm / 7"

GRUENWALD (JANSEN)
41.03.20
20 cm / 8"

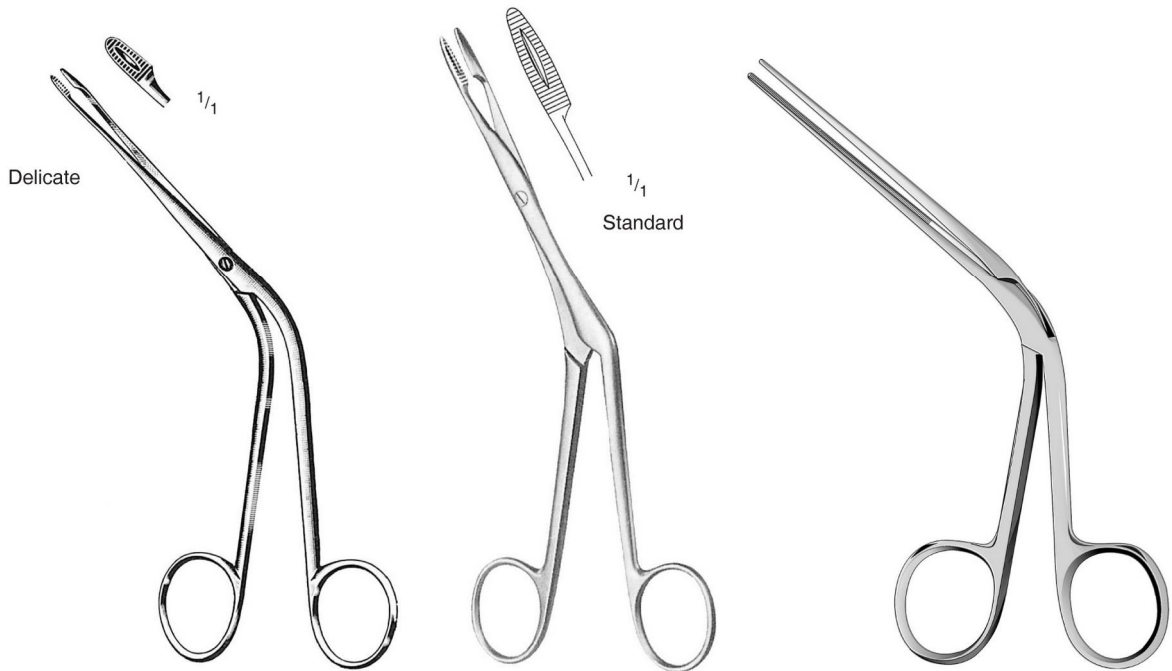

Delicate

Standard

HARTMANN
41.04.16
16 cm / 6 1/4"

HARTMANN
41.05.20
20 cm / 8"

TILLEY
41.07.35
17 cm / 6 3/4"

Nasal Specula

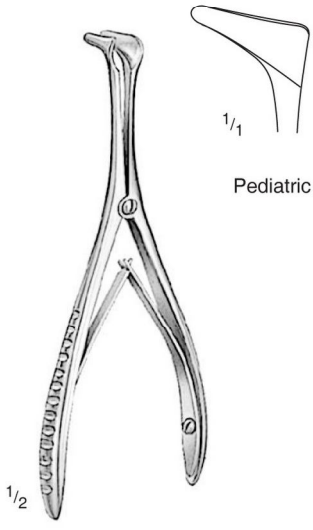

PROFESSIONAL
41.08.03
13 cm / 5"

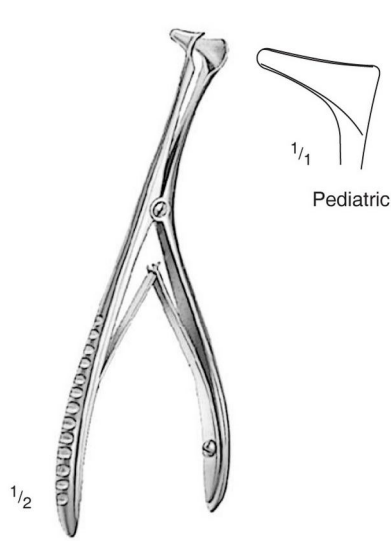

PROFESSIONAL
41.08.04
13 cm / 5"

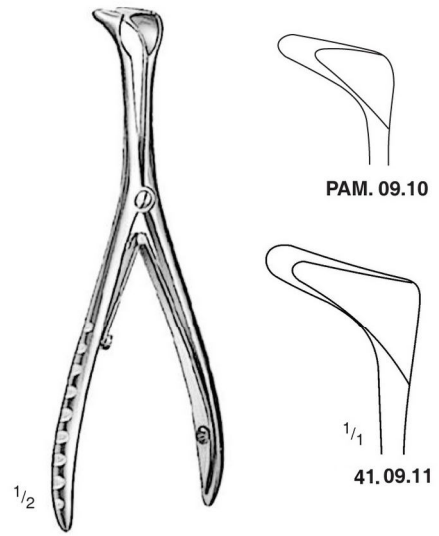

TIECK-HALLE
41.09.10 - 41.09.11
13.5 cm / 5 1/4"

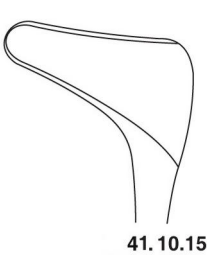

41.10.15

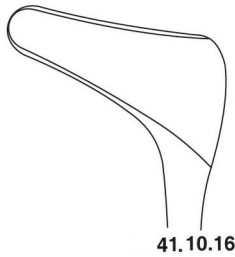

41.10.16

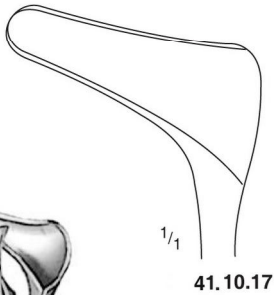

41.10.17



HARTMANN-HALLE
41.10.15 - 41.10.17
15 cm / 6"



COTTLE
41.11.50 - 41.11.53
15 cm / 6"

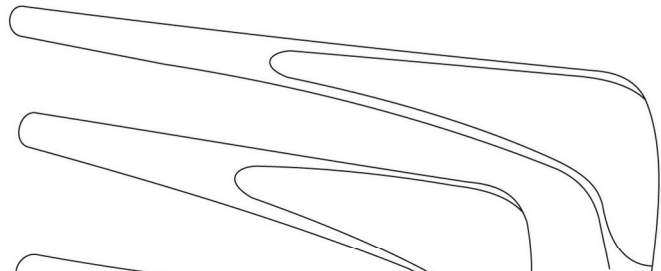

41.11.53
4

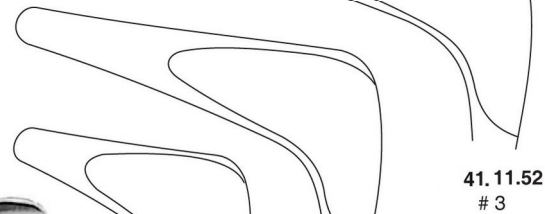

41.11.52
3

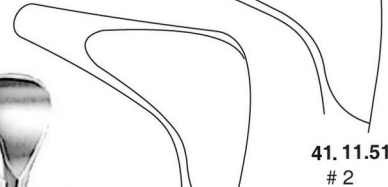

41.11.51
2

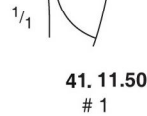

41.11.50
1

Nasal Specula

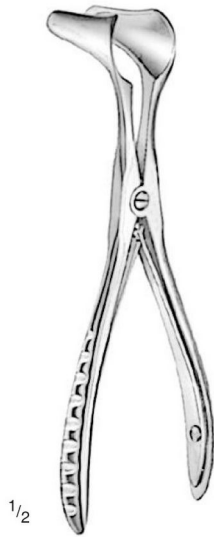

1/2

KILLIAN
41.14.14 – 41.14.17
14 cm / 5 1/2"

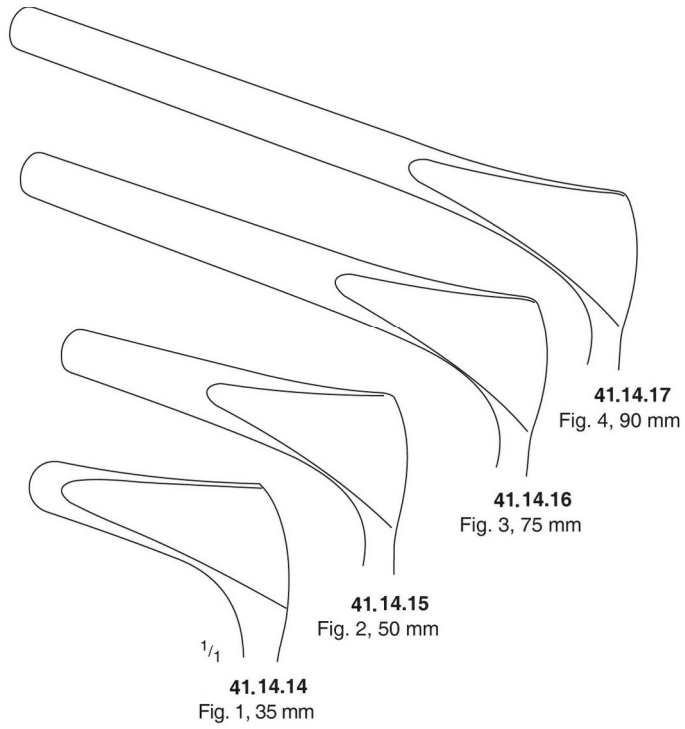

41.14.14
Fig. 1, 35 mm

41.14.15
Fig. 2, 50 mm

41.14.16
Fig. 3, 75 mm

41.14.17
Fig. 4, 90 mm

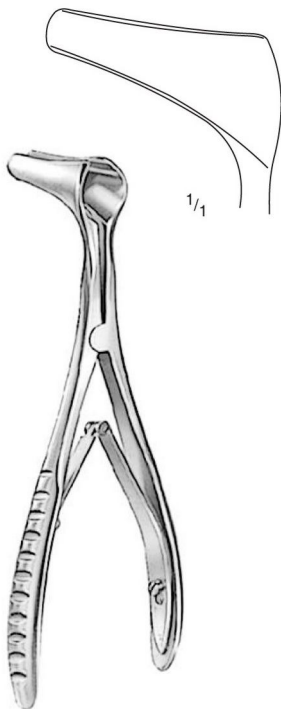

1/1

VIENNA PATTERN
41.16.16
15 cm / 6"

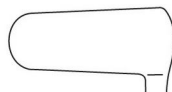

41.17.01
1

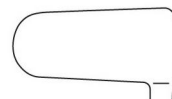

41.17.02
2

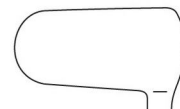

41.17.03
3



GOLDSMITH (THUDICUM)
41.17.01 – 41.17.03
6.5 cm / 2 1/2"

Nasal Scissors, Septum Knives, Septum Elevators

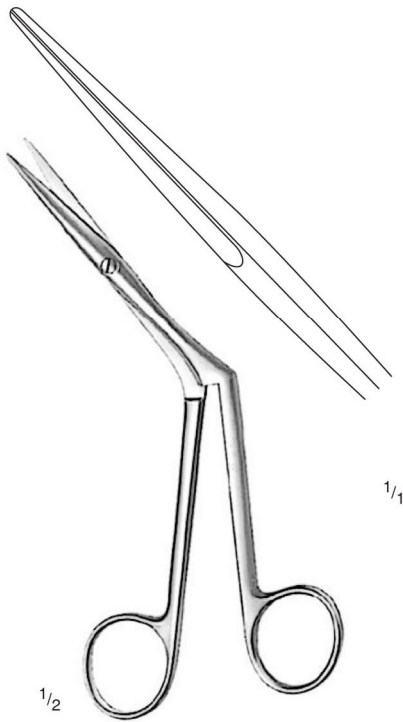

HEYMANN-KNIGHT
41.17.18
18 cm / 7"

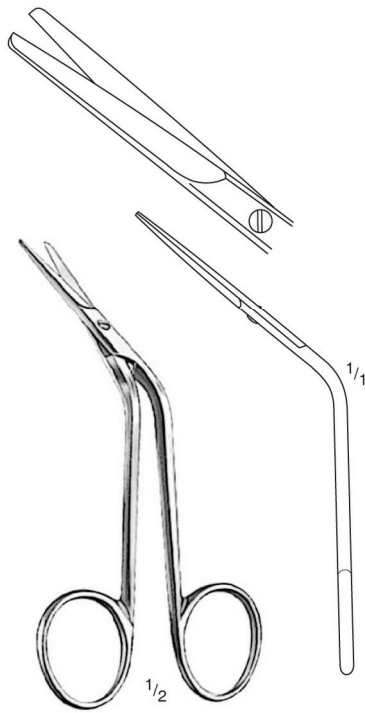

FOMON
41.50.15
15 cm / 6"

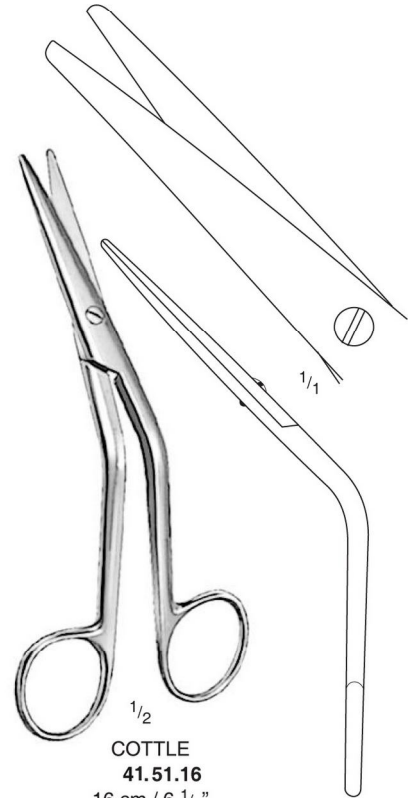

COTTLE
41.51.16
16 cm / 6 1/4"



BLALENGER
41.21.19 - 41.21.22
20 cm / 8"

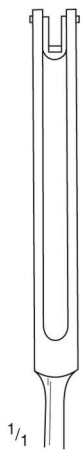

41.21.19
41.22.19
3.0 mm



41.21.20
41.22.20
4.0 mm

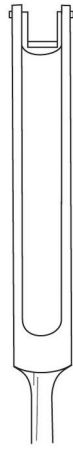

41.21.22
41.22.22
5.0 mm

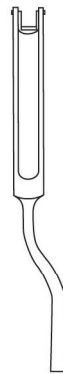

BLALENGER
Bayonet Shape
41.22.19 - 41.22.22
20 cm / 8"



FREER
41.28.21
21 cm / 8 1/4"

Septum Elevators, Compression Forceps

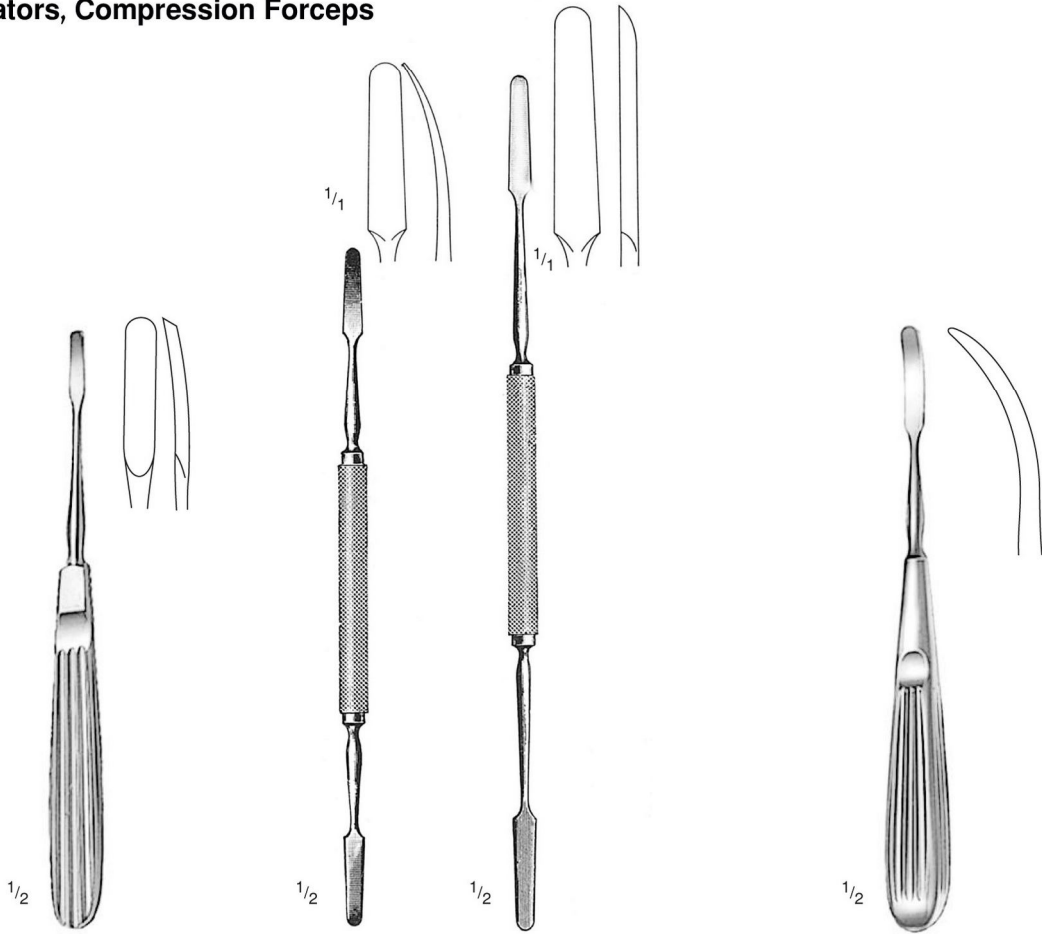

JOSEPH
41.33.16
16 cm / 6 1/4"

KILLIAN
41.34.18
18 cm / 7"

KILLIAN
41.34.22
22 cm / 8 3/4"

JOSEPH
41.35.16
16 cm / 6 1/4"

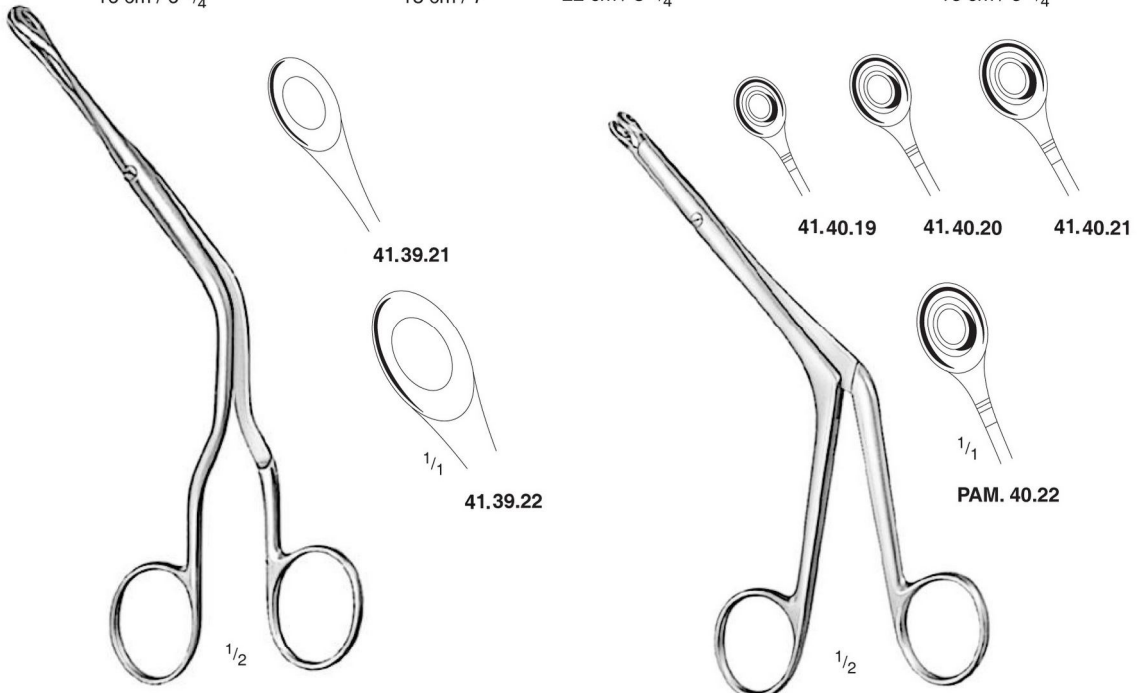

LUC
41.39.21 - 41.39.22
20 cm / 8"

BRUENINGS
41.40.19 - 41.40.22
19 cm / 7 1/2"

Nasal Cutting Forceps

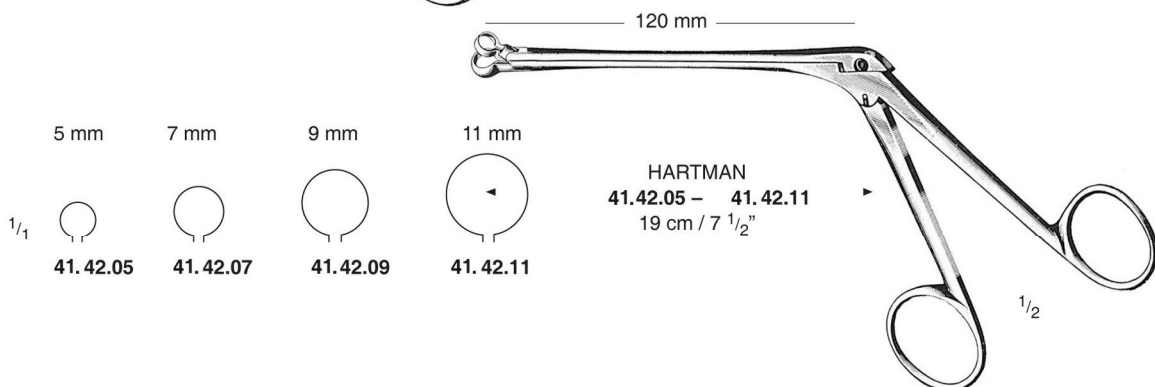
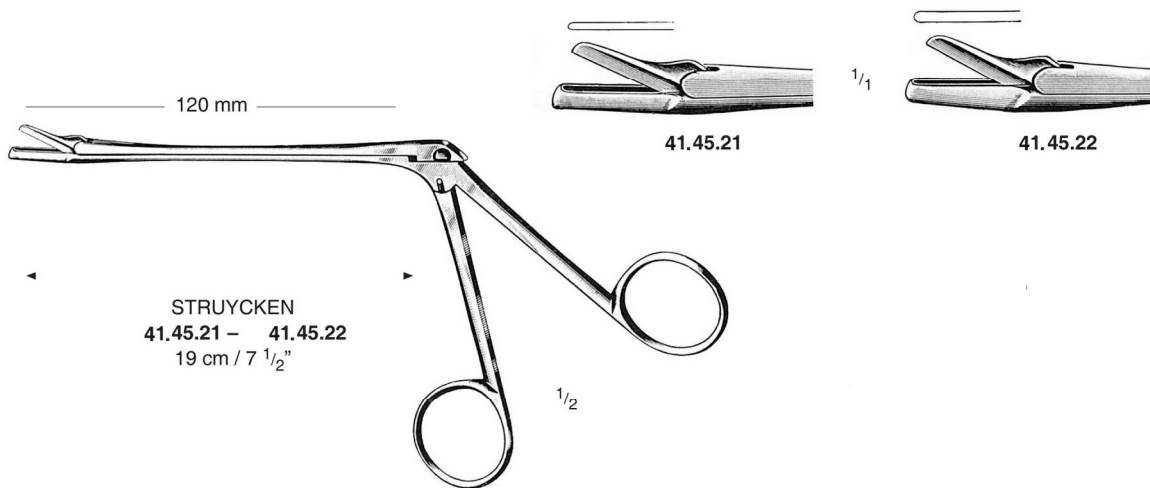
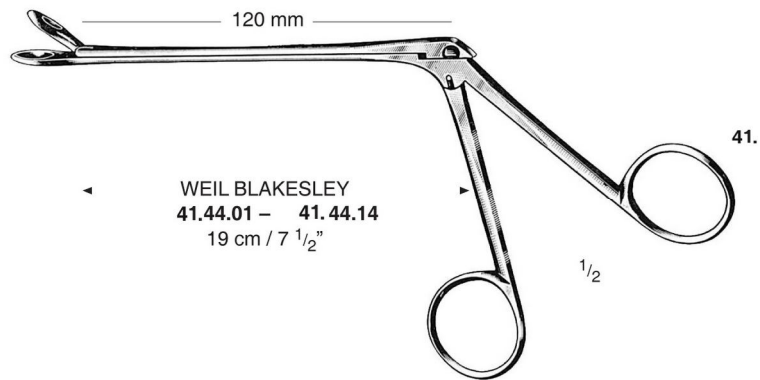

Septum Compression Forceps, Punch Forceps, Rhinoplastic Instruments



JANSEN MIDDLETON
41.49.19
19 cm / 7 1/2"

- 3 mm
41.65.01
- 4 mm
41.65.02
- 5 mm
41.65.03
- 6 mm
41.65.04



KERRISON
41.65.01 – 41.65.04
20 cm / 8"



FOMON
41.01.15
15 cm / 6"



JOSEPH
41.08.15
15 cm / 6"



CONVERSE
41.09.12
12 cm / 4 3/4"

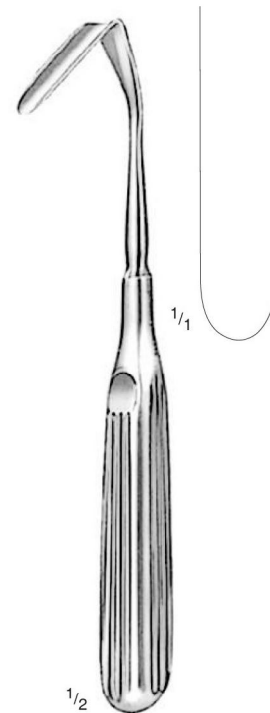

AUFRICHT
41.10.19
19 cm / 7 1/2"

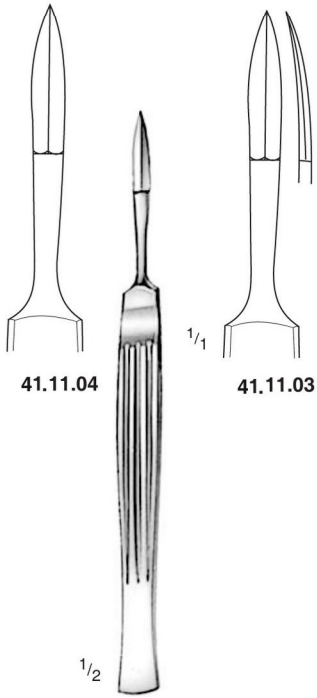

41.11.04

41.11.03

1/2

JOSEPH
41.11.03 – 41.11.04
16 cm / 6 1/4"

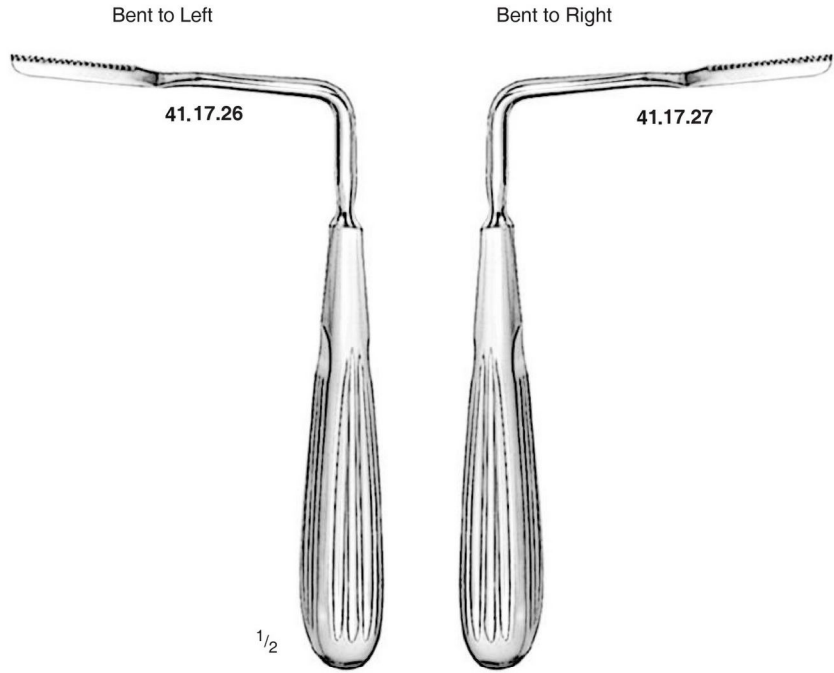

41.17.26

41.17.27

1/2

JOSEPH
41.17.26 – 41.17.27
17 cm / 6 3/4"

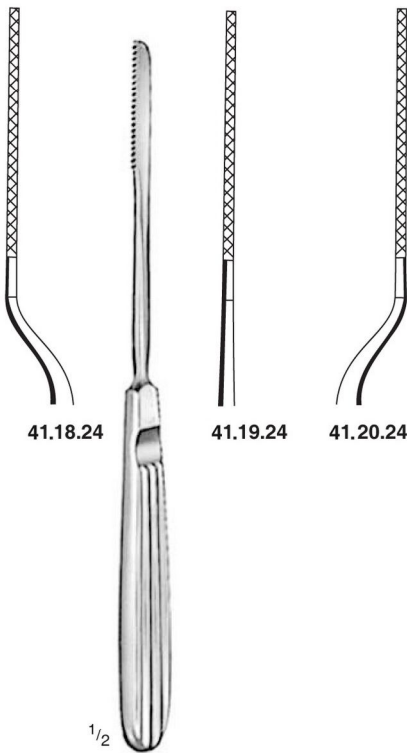

41.18.24

41.19.24

41.20.24

1/2

JOSEPH
41.18.24 – 41.20.24
19 cm / 7 1/2"

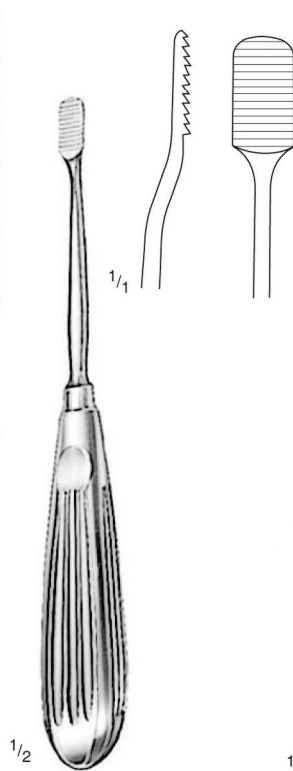

1/4

1/2

LEWIS
41.24.26
18 cm / 7"

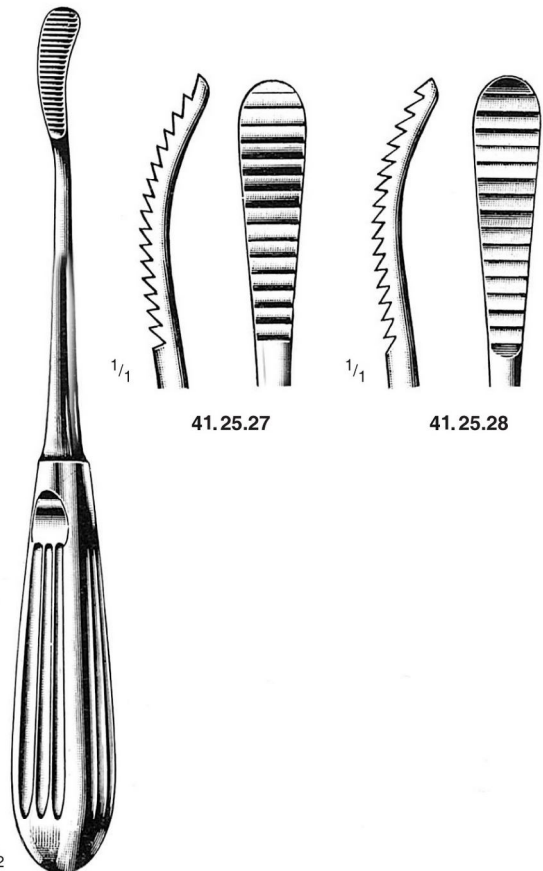

1/4

1/4

41.25.27

41.25.28

1/2

AUFRICHT
41.25.27 – 41.25.28
21 cm / 8 1/4"

Rhinoplastic Instruments

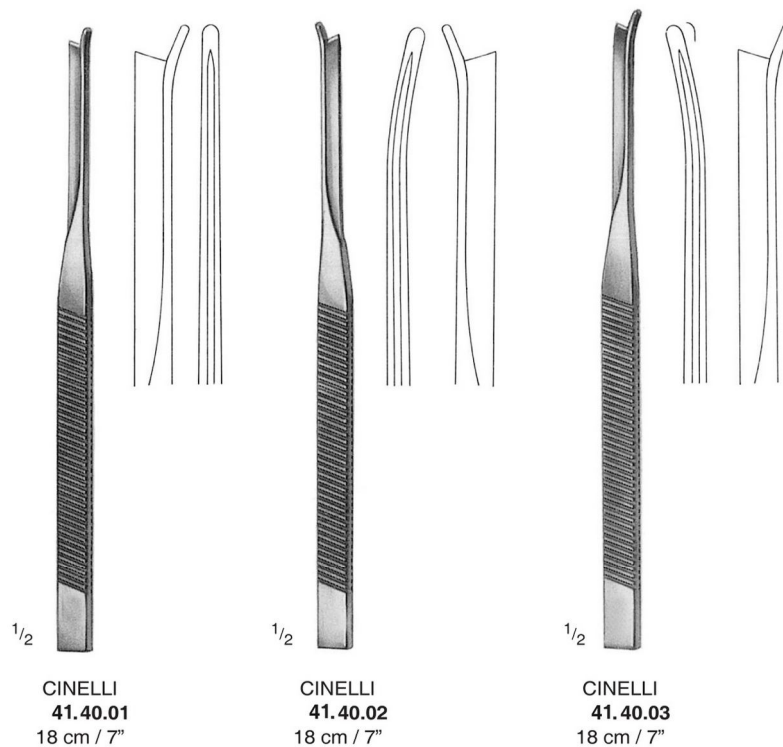
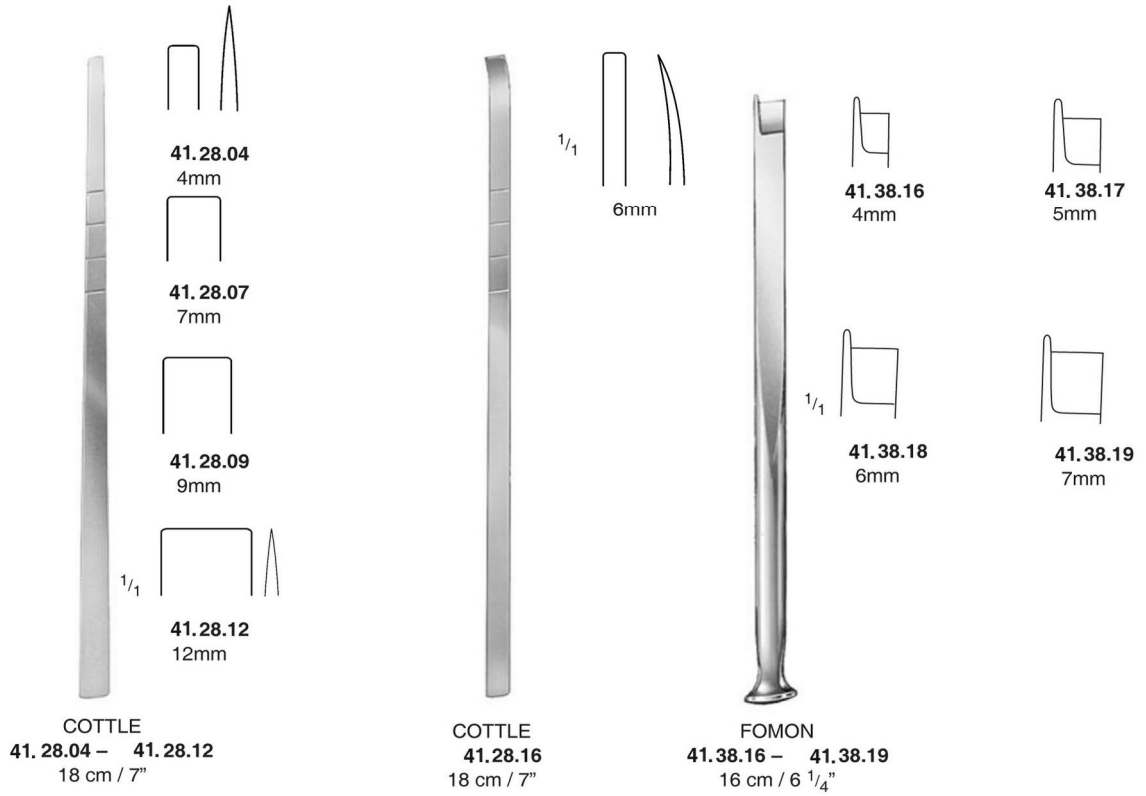

Septum Forceps

