

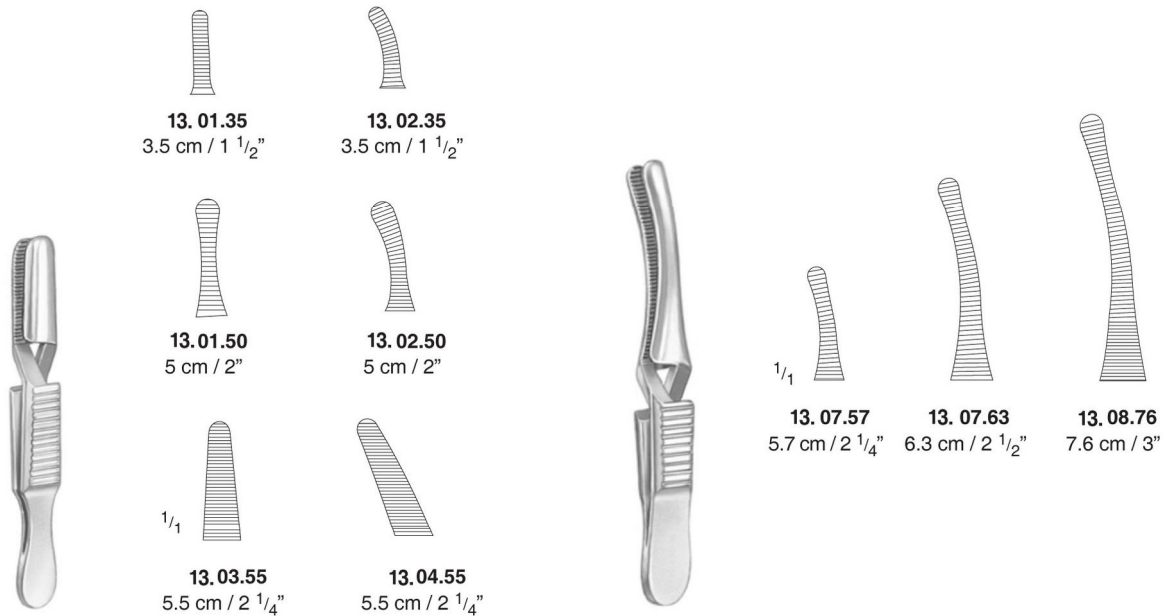

Hemostatic Forceps
Pincas Hemostaticas
Pnces Hemostatiques

Tel# 0092-52-4260785
Fax# 0092-52-4266804
Email. Info@benison.com.pk

Bulldog Clamps



DIEFFENBACH
13.01.35 – 13.04.55

JOHNS- HOPKINS
13.07.57 – 13.08.76

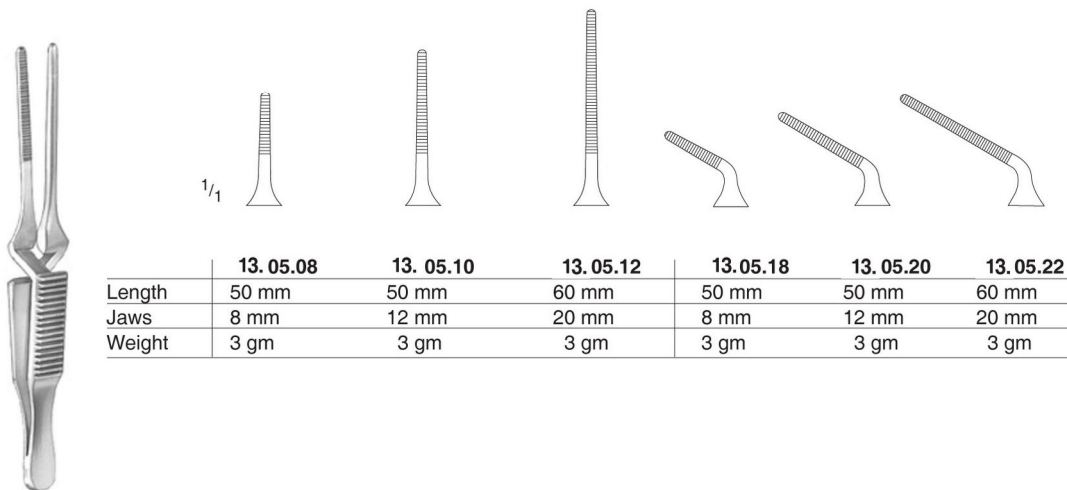

DIETHRIC
13.05.08 – 13.05.22

	13.05.08	13.05.10	13.05.12	13.05.18	13.05.20	13.05.22
Length	50 mm	50 mm	60 mm	50 mm	50 mm	60 mm
Jaws	8 mm	12 mm	20 mm	8 mm	12 mm	20 mm
Weight	3 gm	3 gm	3 gm	3 gm	3 gm	3 gm

Bulldog Clamps



HALSTEAD MOSQUITO
13.10.12 - 13.19.14

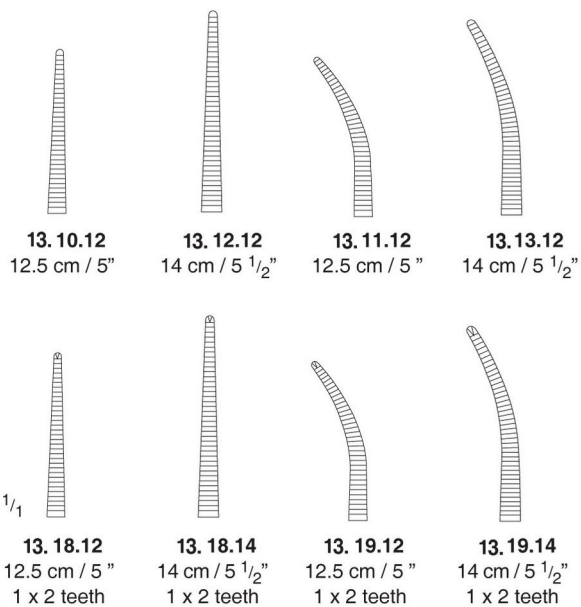

MICRO- HALSTEAD MOSQUITO
13.10.22 - 13.19.22

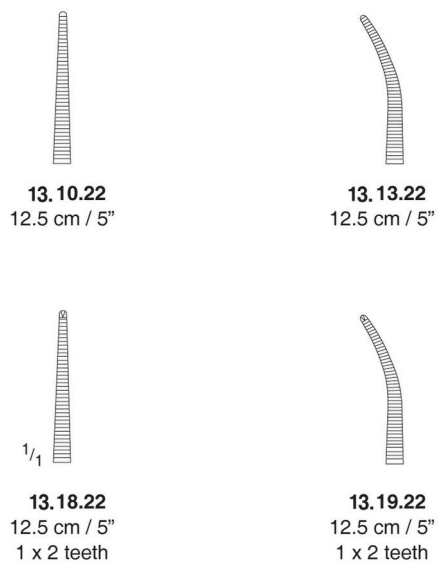

Artery Forceps



CHAPUT
13.20.13
13 cm / 5"



TUFFIER
13.22.13
13 cm / 5"

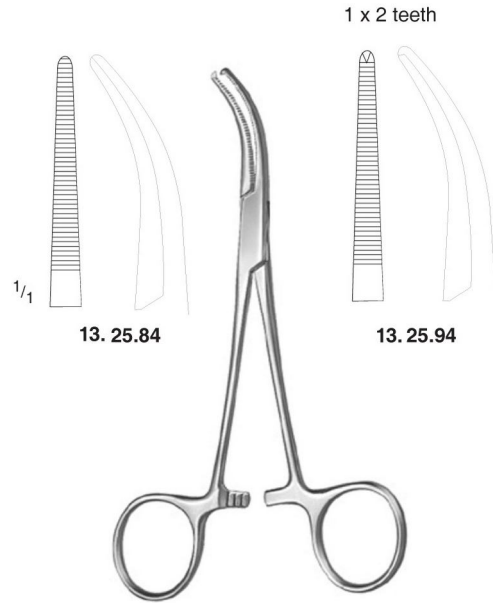

DANDY
13.25.84 - 13.25.94
14 cm / 5 1/2"

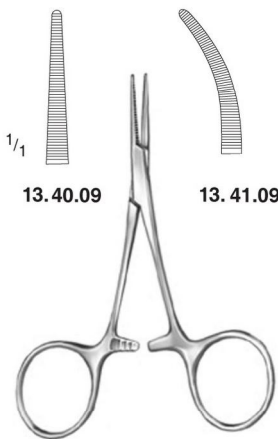

HARTMANN
(BABY MOSQUITO)
13.40.09 - 13.41.09
9 cm / 3 1/2"

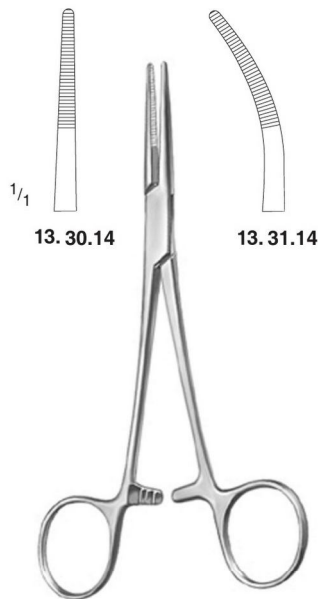

PROVIDENCE HOSPITAL
13.30.14 - 13.31.14
14 cm / 5 1/2"

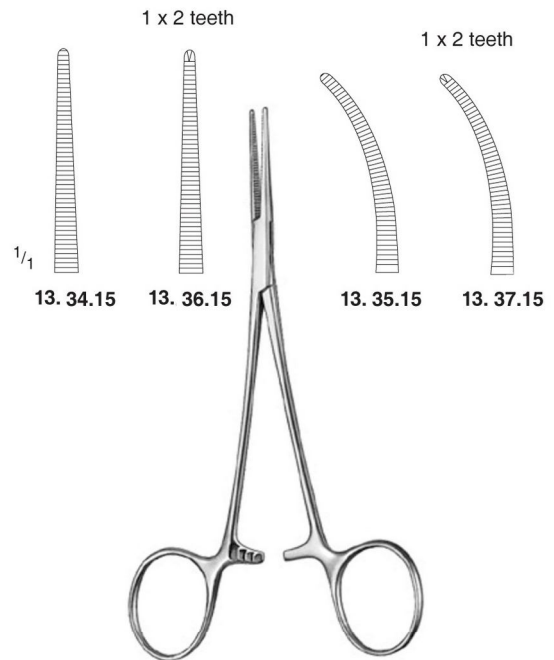

LERICHE
13.34.15 - 13.37.15
15 cm / 6"

Artery Forceps

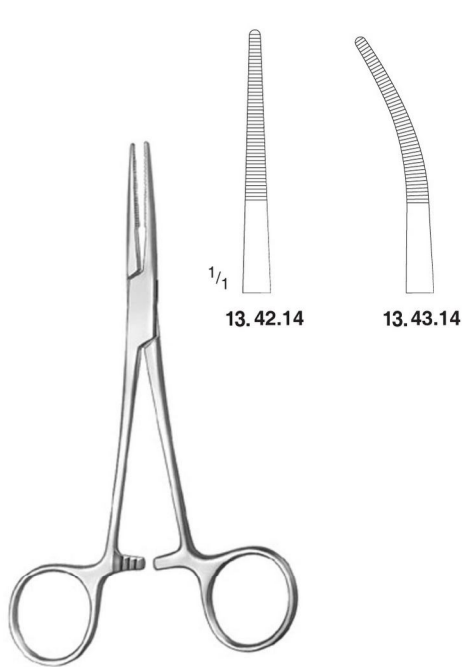

KELLY
13. 42.14 – 13. 43.14
14 cm / 5 1/2"

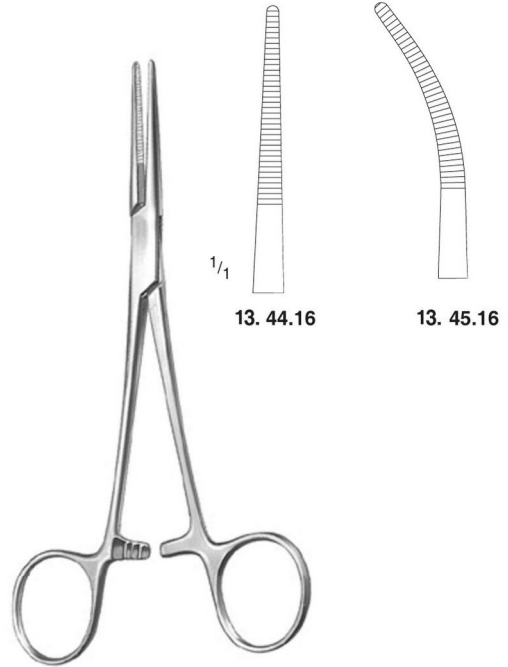

RANKIN-KELLY
13. 44.16 – 13. 45.16
16 cm / 6 1/4"

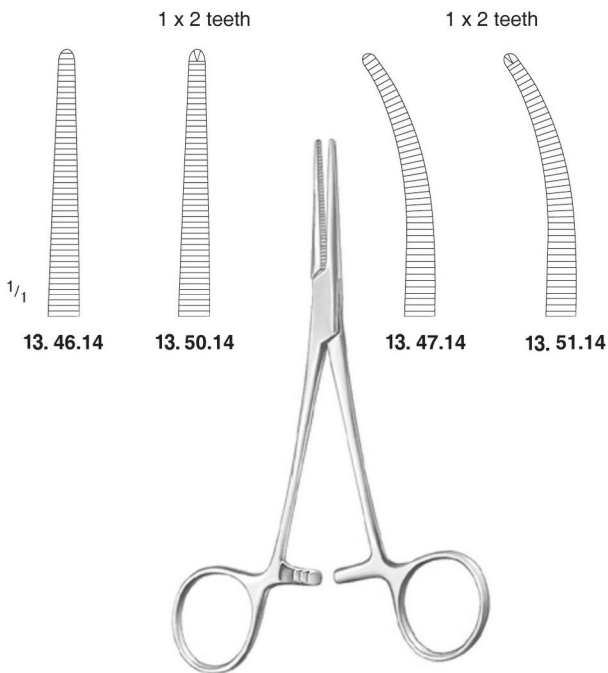

CRILE
13. 46.14 – 13. 51.14
14 cm / 5 1/2"

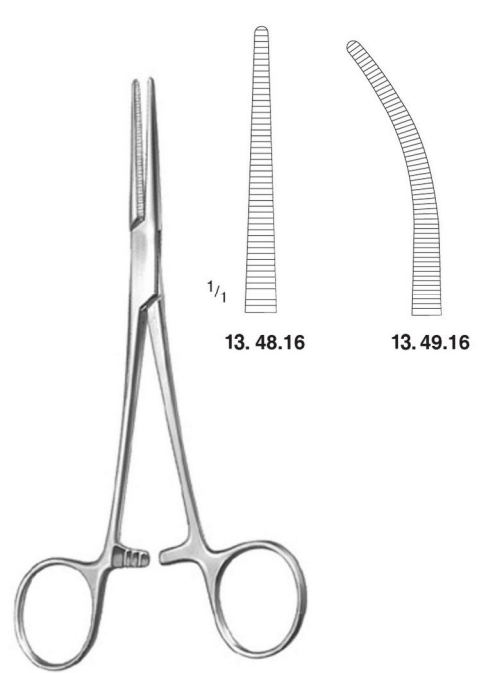

RANKIN-CRILE
13. 48.16 – 13. 49.16
16 cm / 6 1/4"

Artery Forceps

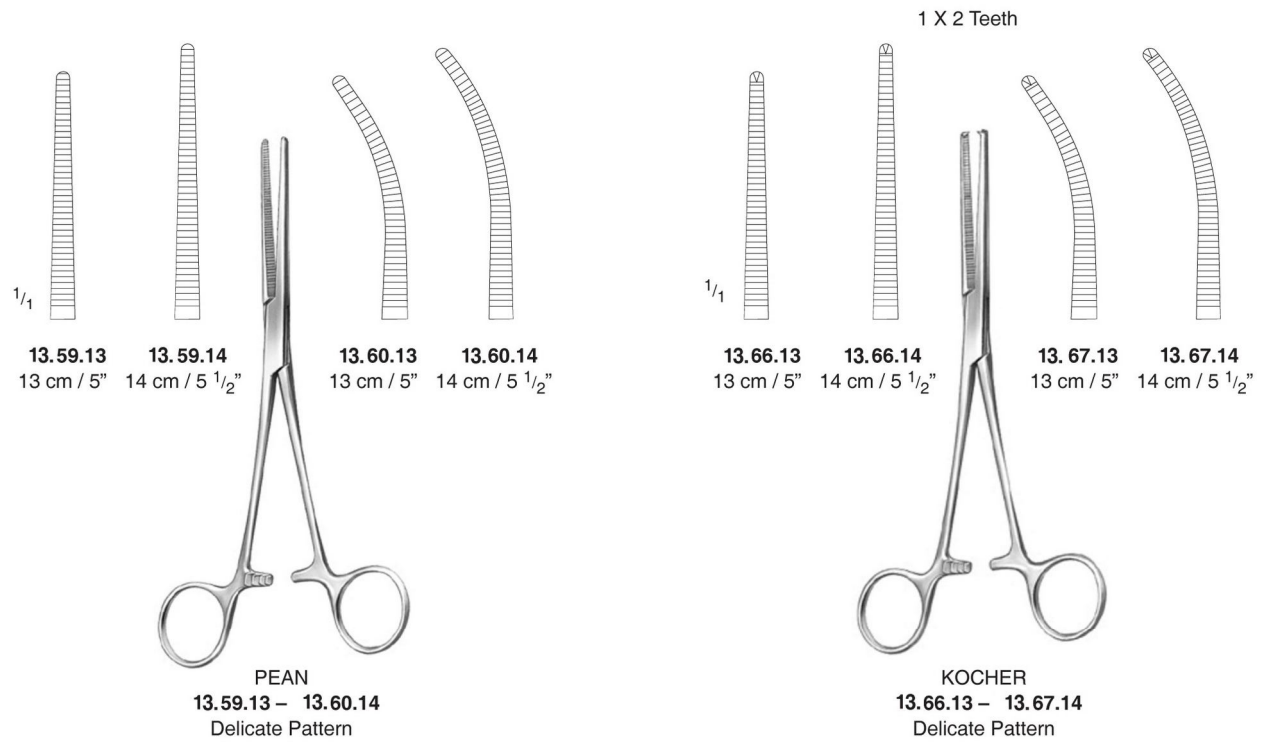
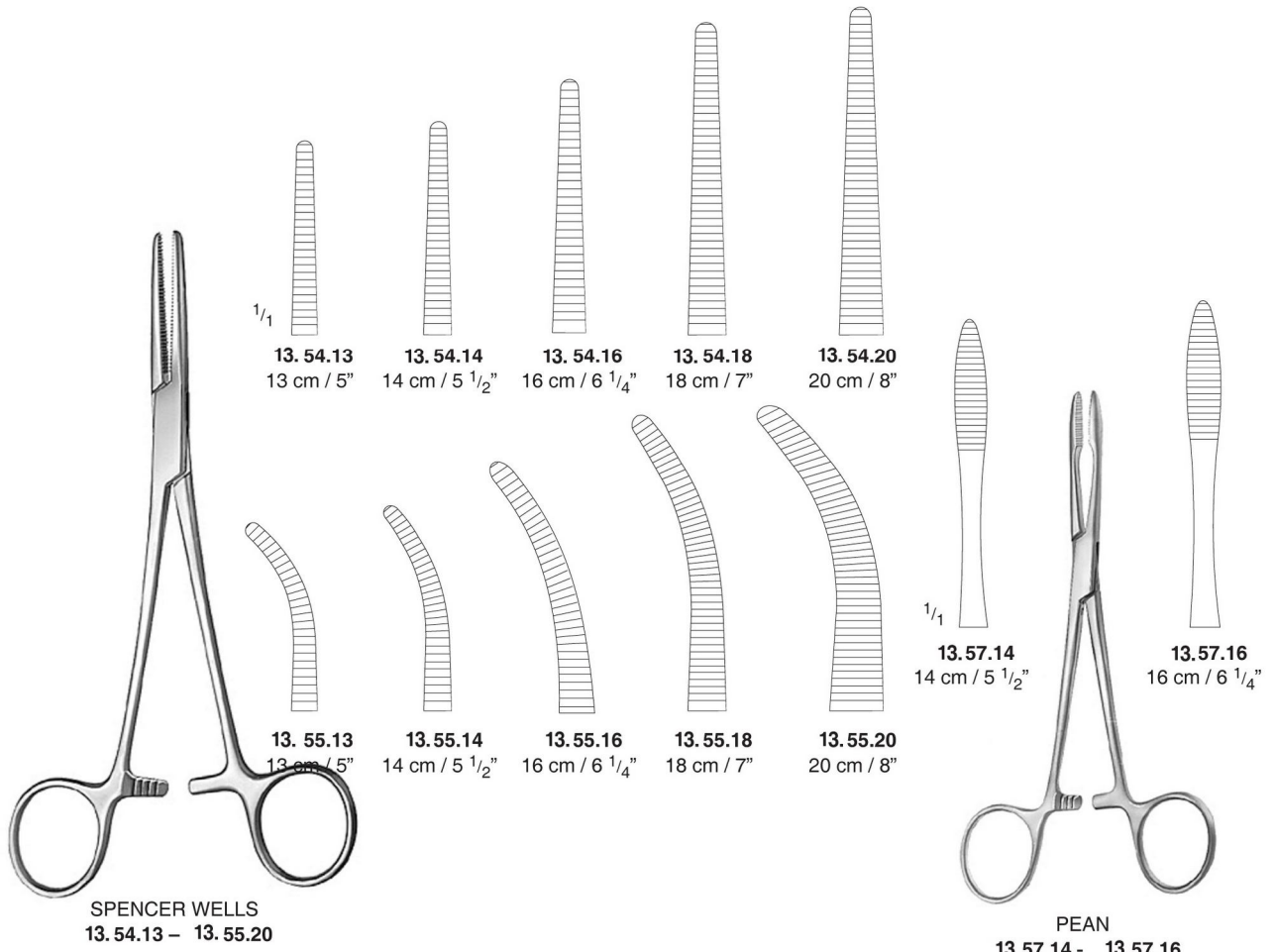

Artery Forceps

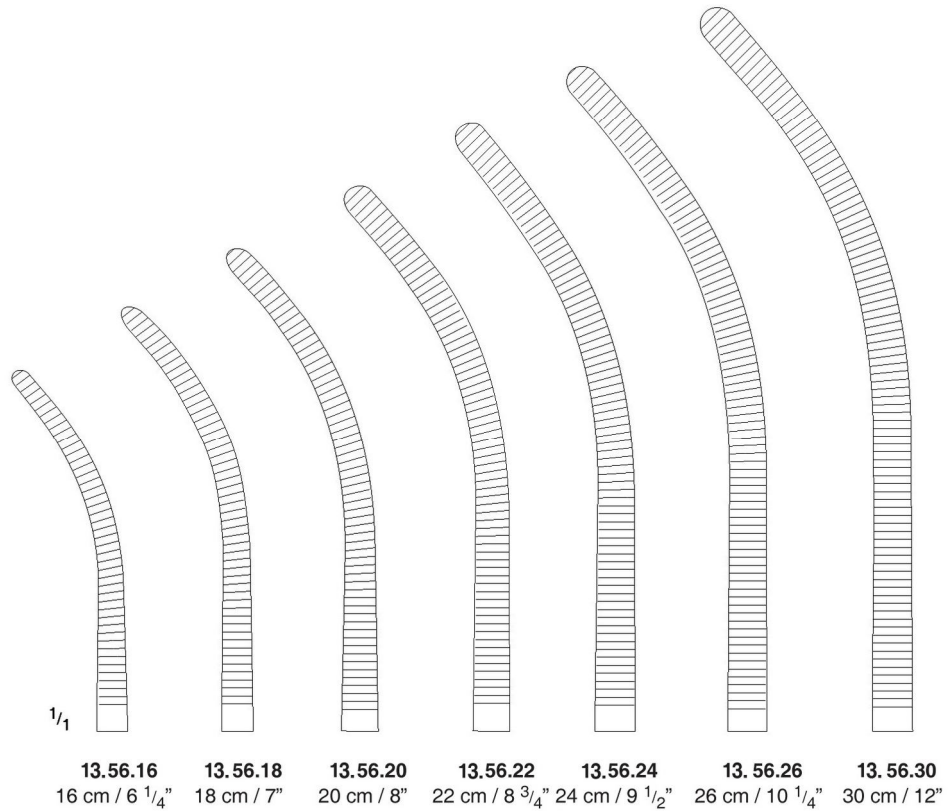
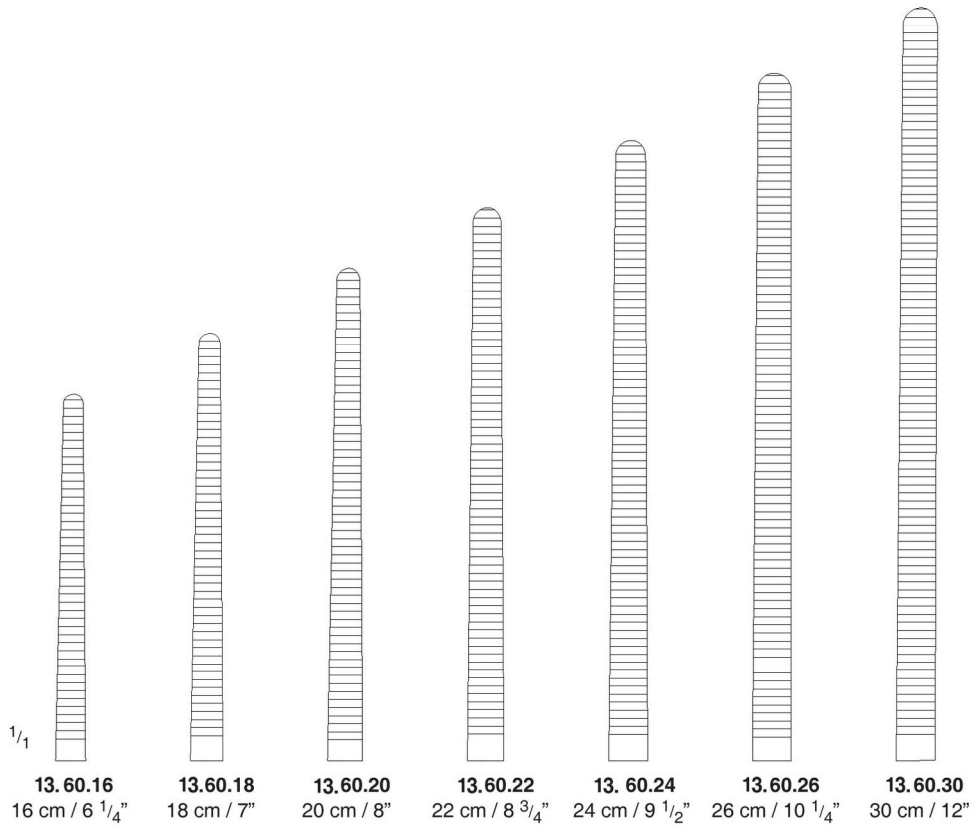

PEAN (ROCHESTER)
 13.60.16 – PH. 60.30
 13.56.16 – PH. 56.30

Artery Forceps

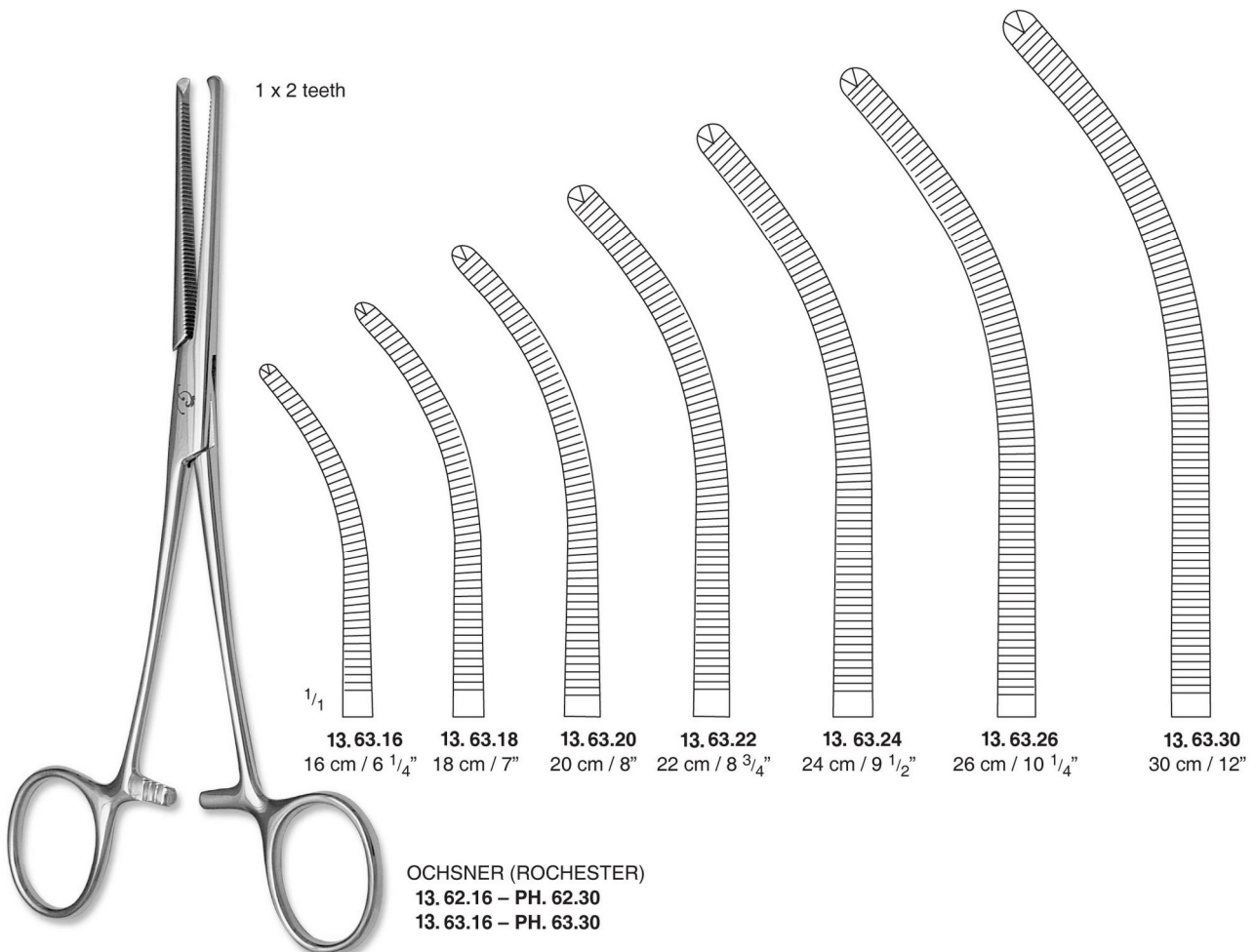
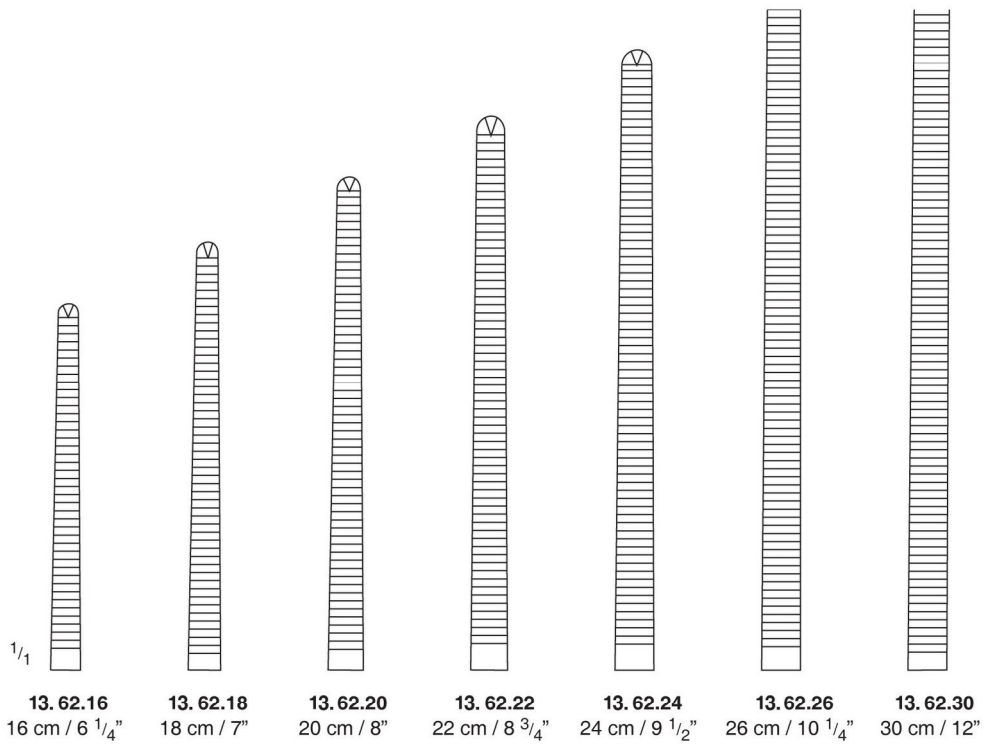

Artery Forceps

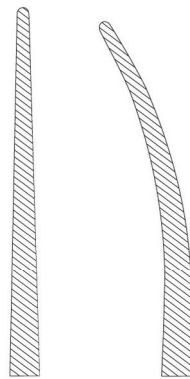

13.64.20 13.64.21
20 cm / 8"

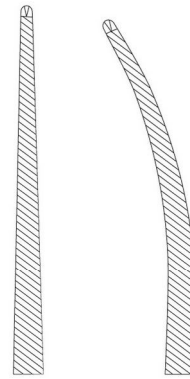

13.65.20 13.65.21
20 cm / 8"
1x2 teeth



BENGOLEA
13.64.20 – 13.65.27

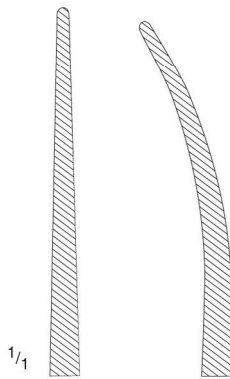

13.64.26 13.64.27
26 cm / 10 1/4"

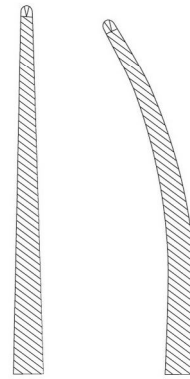

13.65.26 13.65.27
26 cm / 10 1/4"
1x2 teeth

Artery Forceps

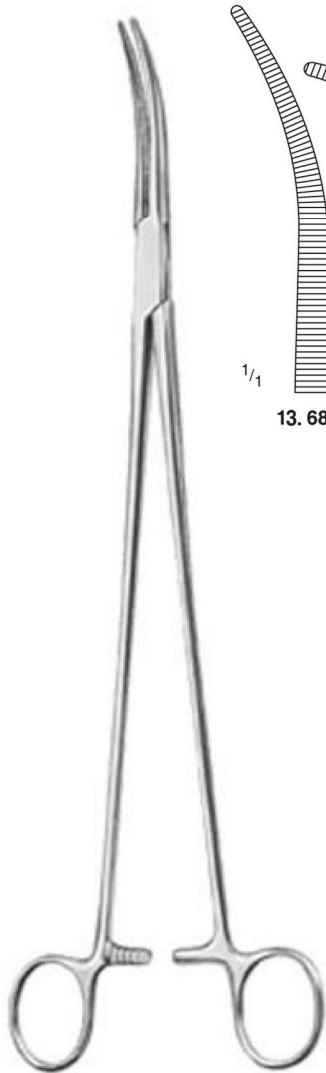

ZENKER
13.68.29 - 13.68.30
29.5 cm / 11 1/2"

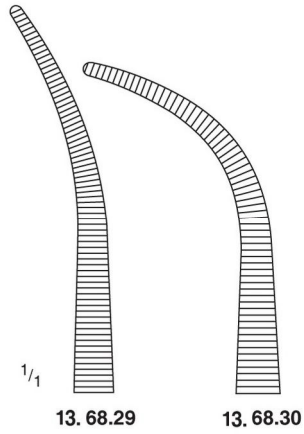

13.68.29

13.68.30



RUMEL
13.69.01 - 13.69.05
23 cm / 9"

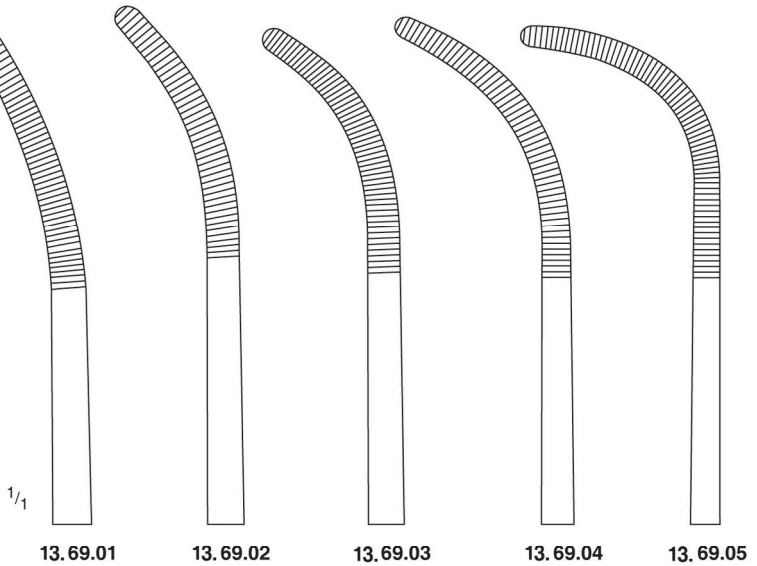

13.69.01

13.69.02

13.69.03

13.69.04

13.69.05

Artery Forceps, Hysterectomy and Vaginal Clamp Forceps

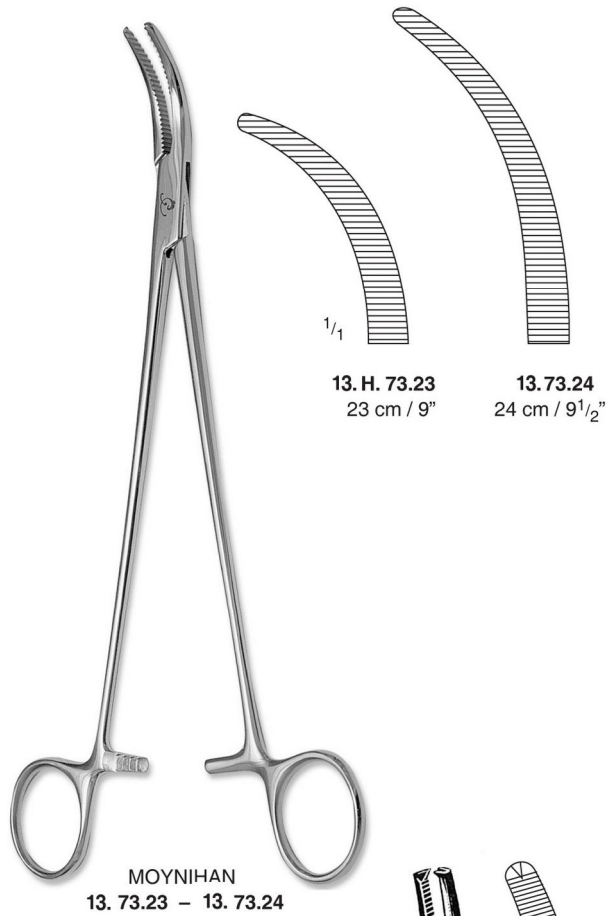

13. H. 73.23
23 cm / 9"

13. 73.24
24 cm / 9 1/2"

MOYNIHAN
13. 73.23 - 13. 73.24

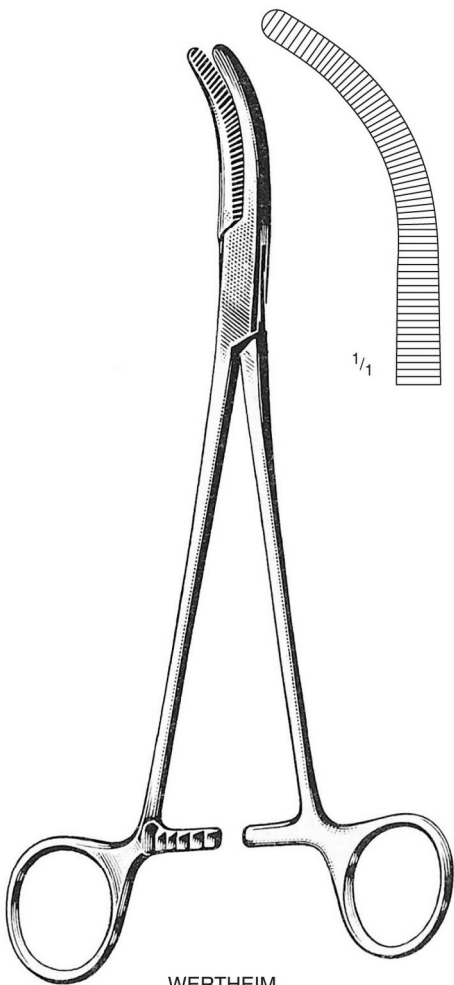

WERTHEIM
13. 86.24
24 cm / 9 1/2"

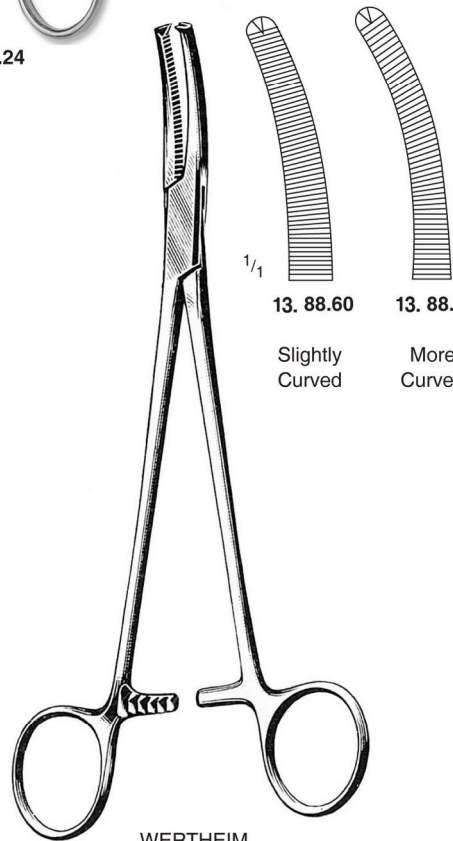

13. 88.60

Slightly
Curved

13. 88.61

More
Curved

WERTHEIM
13. 88.60 - 13. 88.61
20 cm / 8"

Artery Forceps, Clamps

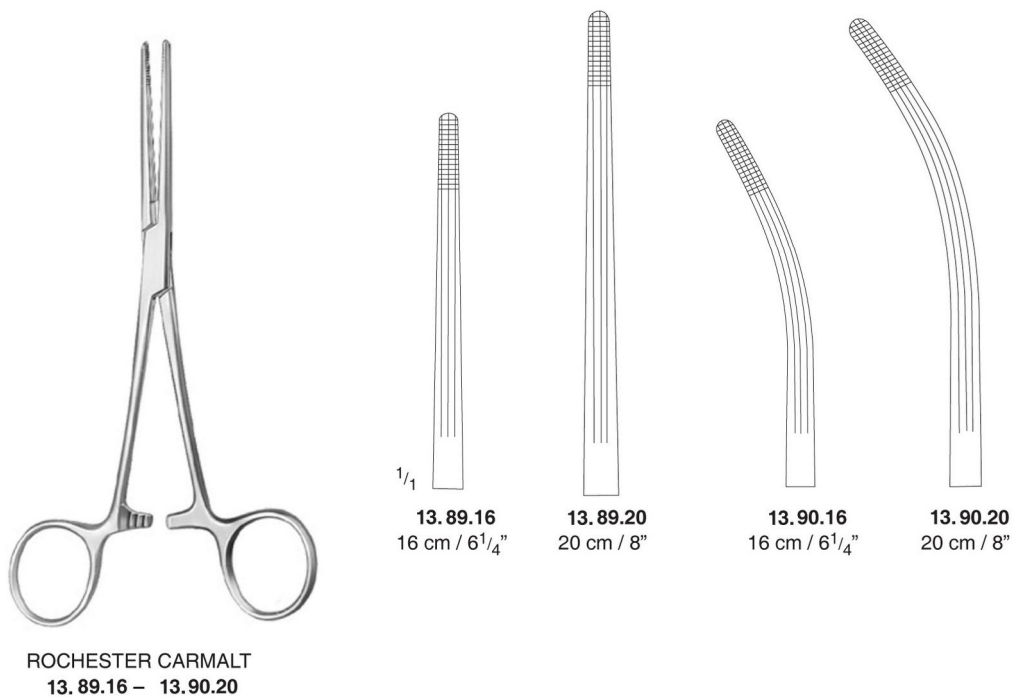
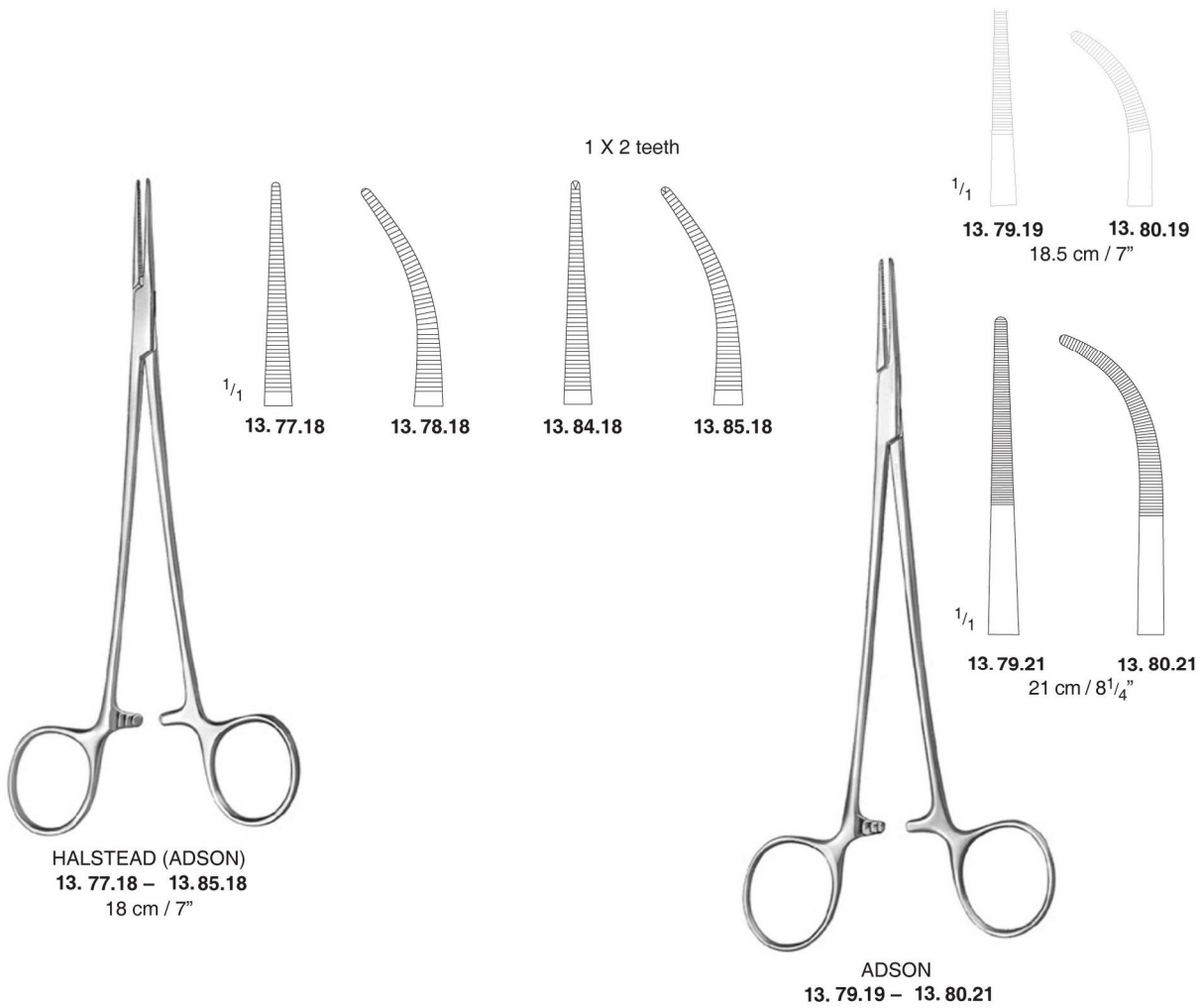

Peritoneal Clamp Forceps

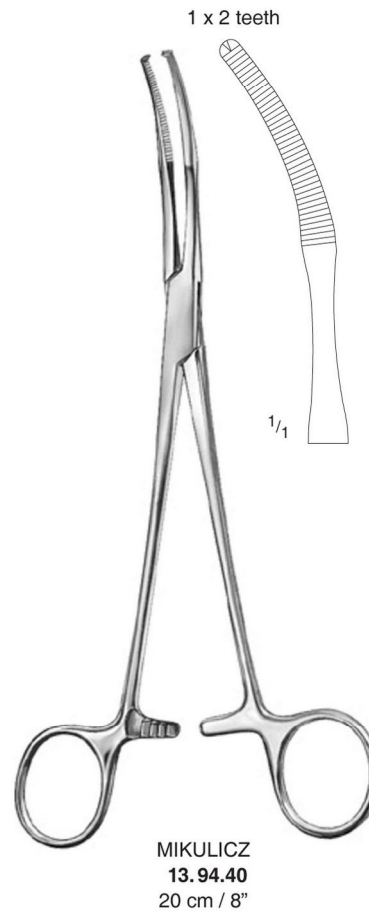
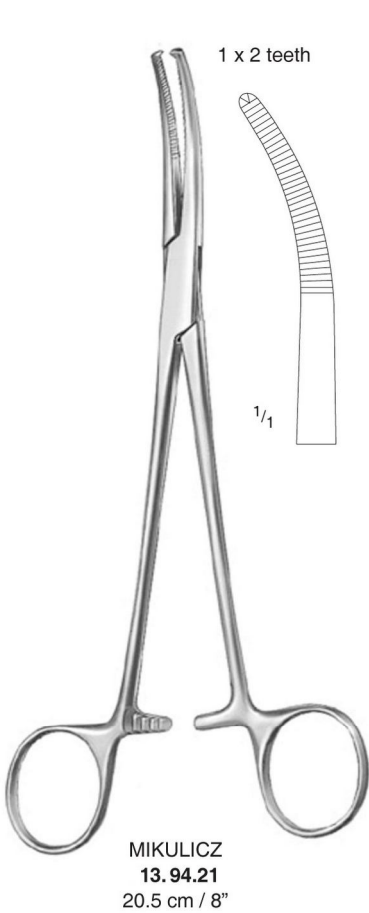
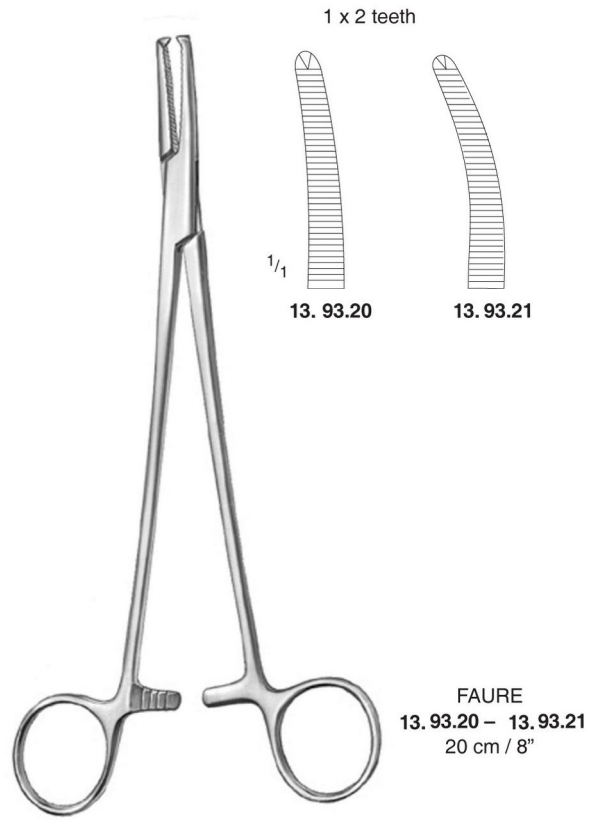
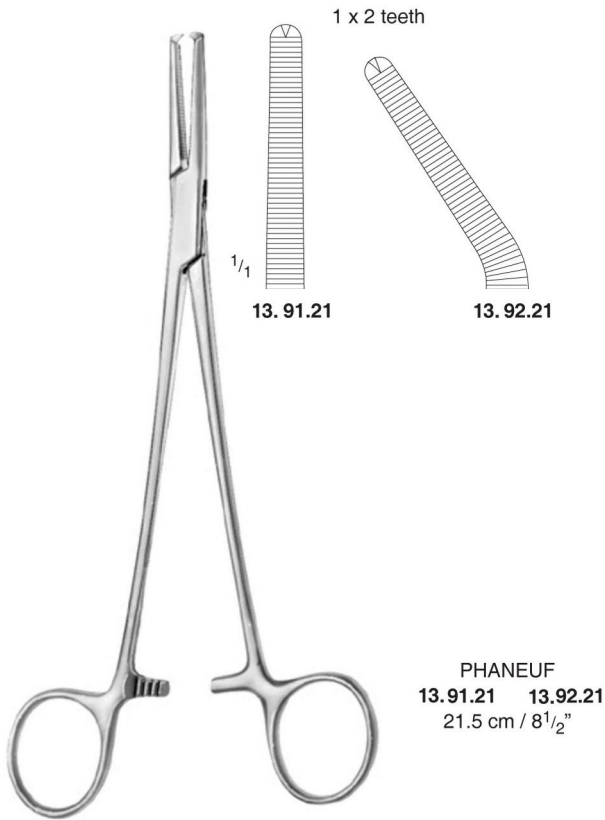

Peritoneal Clamp Forceps

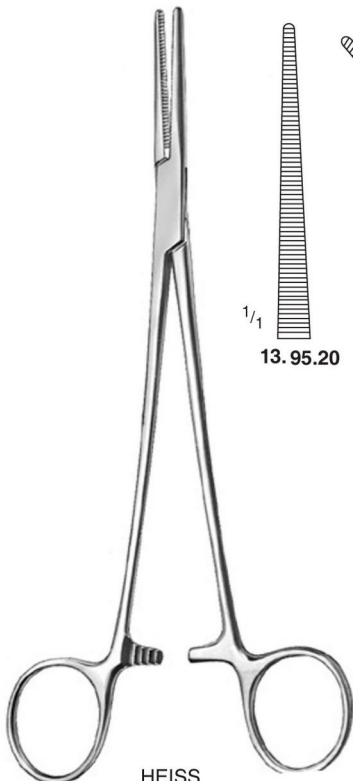

HEISS
13.95.20 - 13.96.21
20 cm / 8"

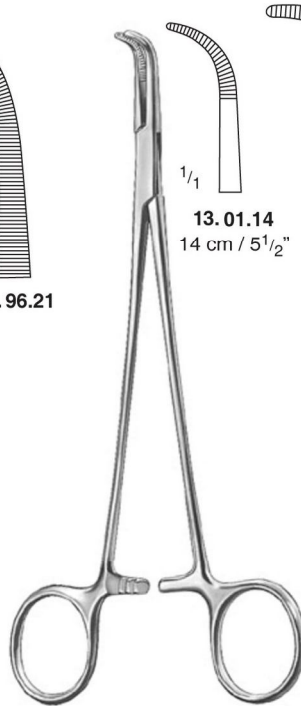
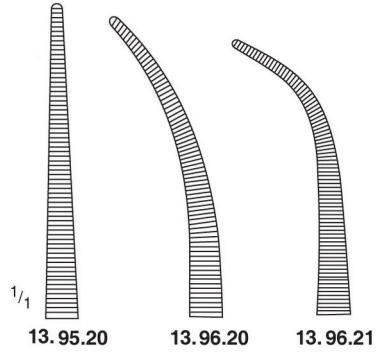

ADSON BABY
13.01.14 - 13.02.19

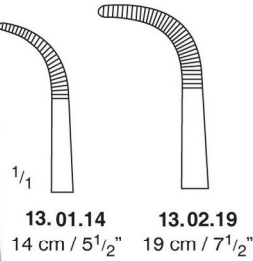

MIXTER BABY
13.04.19
19 cm / 7 1/2"

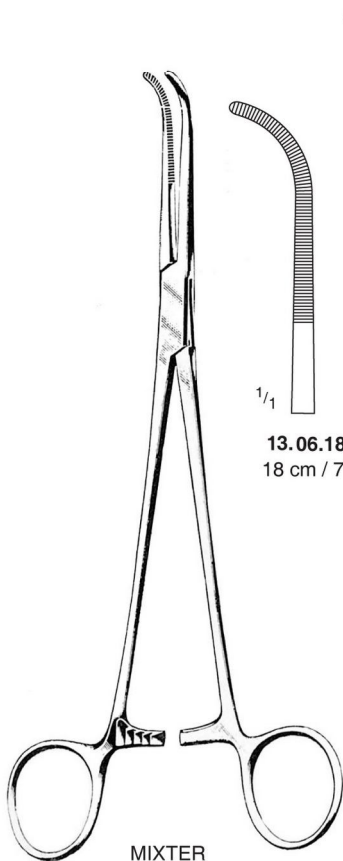

MIXTER
13.06.18 - 13.06.23

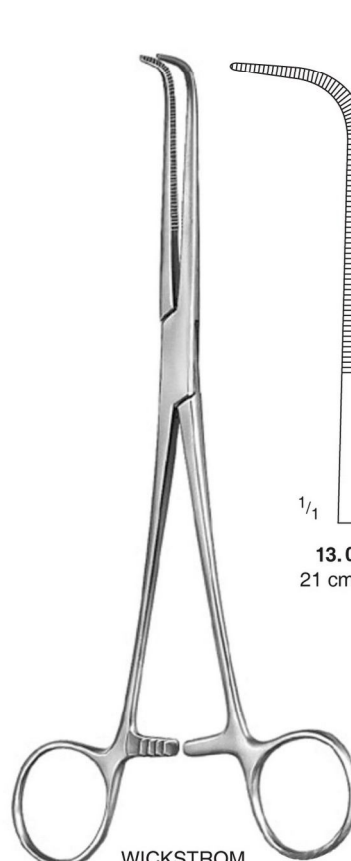
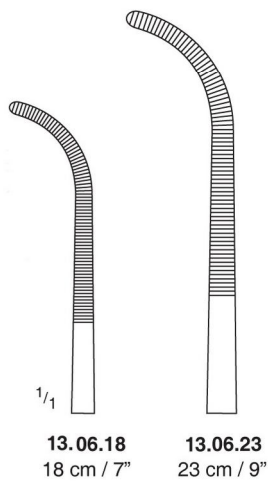

WICKSTROM
13.07.81 - 13.07.84

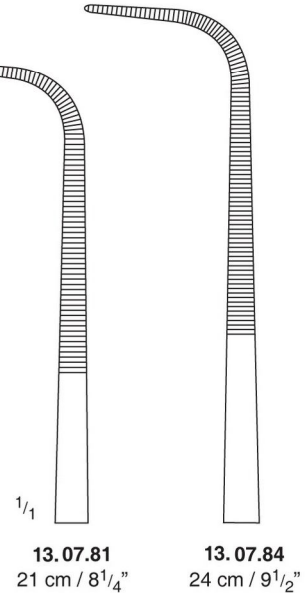

Artery Forceps, Dissecting and Ligature Forceps, Bronchus and Gall Duct Clamps

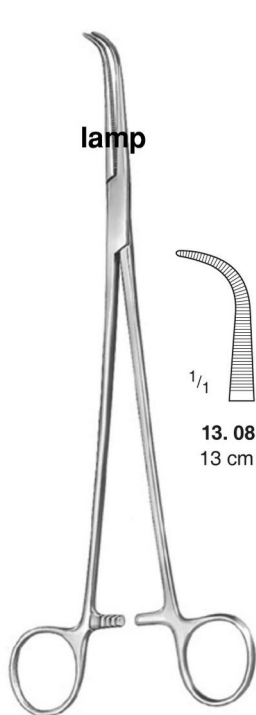

lamp

GEMINI
13.08.13 - 13.09.28

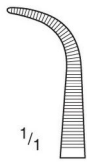

13.08.13
13 cm / 5"

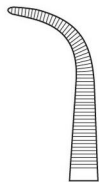

13.08.14
14 cm / 5 1/2"

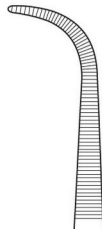

13.08.18
18 cm / 7"

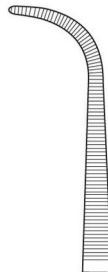

13.08.20
20 cm / 8"



13.09.23
23 cm / 9"



13.09.25
25 cm / 10"

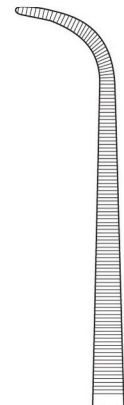

13.09.28
28 cm / 11"

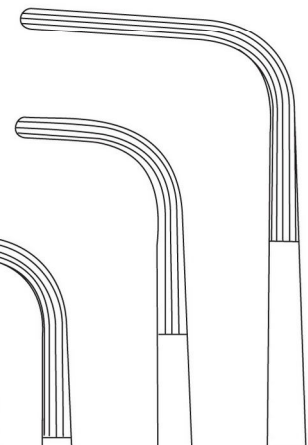

13.13.27
27 cm / 10 3/4"

13.13.25
25 cm / 10"

13.13.22
22 cm / 8 3/4"



SCHNIDT
13.11.51 - 13.11.56
19 cm / 7 1/2"



13.11.51

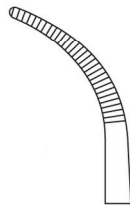

13.11.56

Tonsil Seizing
Forceps

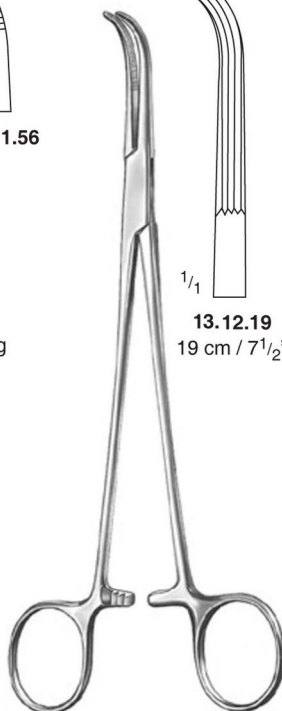

LAHEY
13.12.19 - 13.12.23



13.12.19
19 cm / 7 1/2"

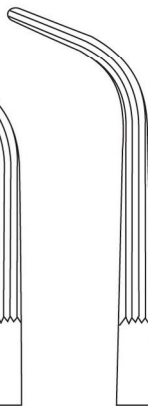

13.12.23
23 cm / 9"

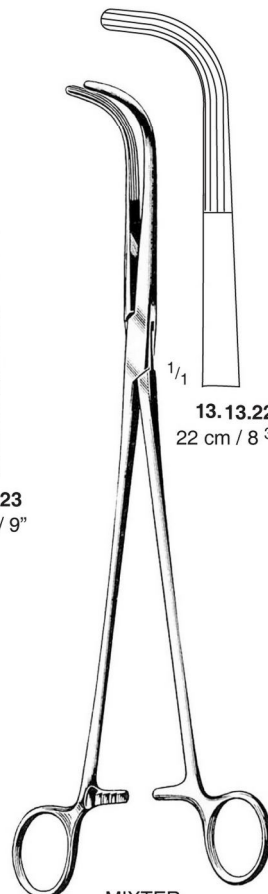

MIXTER
13.13.22 - 13.13.27

1/1

1/2

Tissue and Organ Holding Forceps

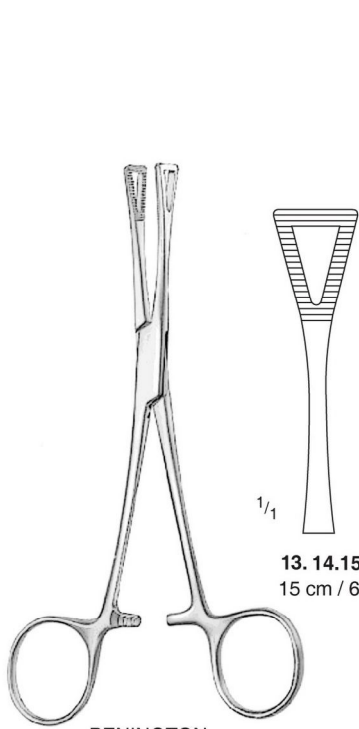

PENINGTON
13.14.15 – 13.14.20

1/4
13.14.15
15 cm / 6"

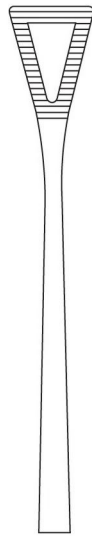

13.14.20
20 cm / 8"

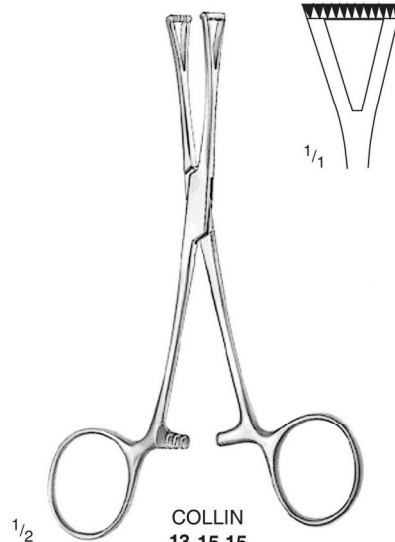

COLLIN
13.15.15
15 cm / 6"

1/2

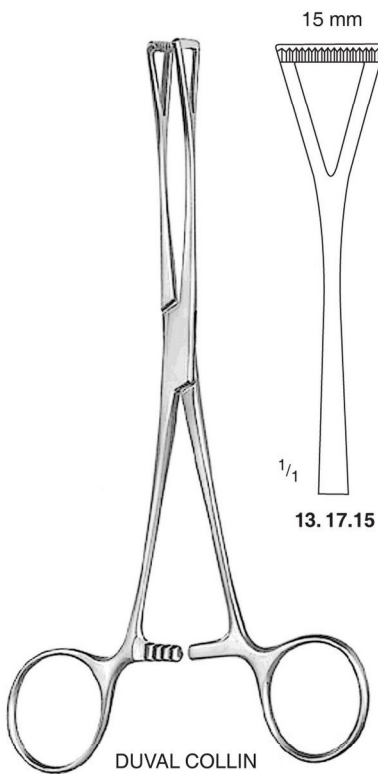

DUVAL COLLIN
13.17.15 – 13.17.25
21 cm / 8 1/4"



13.17.15

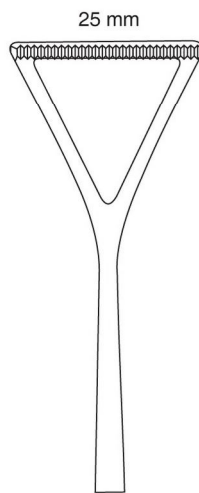

13.17.25

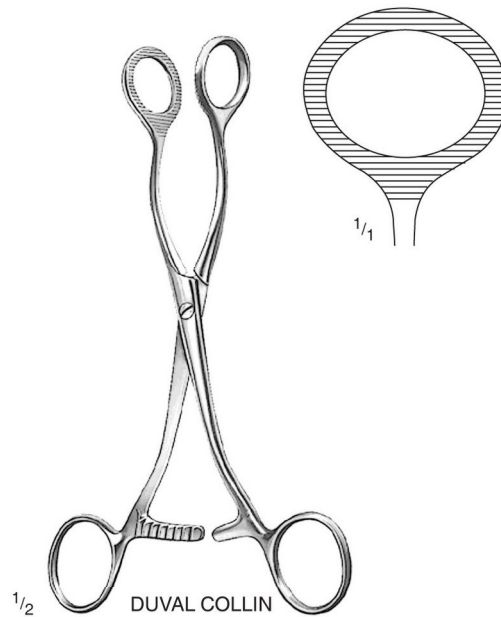

DUVAL COLLIN
13.17.16
16 cm / 6 1/4"

1/2

Towel Forceps



JONES
13. 20.09
9 cm / 3 1/2"



SCHAEDEL
13. 21.09
9 cm / 3 1/2"



BACKHAUS
13. 25.08 – 8.5 cm / 3 1/4"
13. 25.10 – 10.5 cm / 4 1/4"
13. 26.13 – 13 cm / 5"
13. 26.15 – 15 cm / 6"



BACKHAUS-ROEDER
13.28.13 – 13 cm / 5"
13.28.15 – 15 cm / 6"



BALL & SOCKET
13.30.13 – 13 cm / 5"
13.30.15 – 15 cm / 6"



LANE
13.33.15 – 15 cm / 6"
13.33.18 – 18 cm / 7"
13.33.20 – 20 cm / 8"

Tubing Clamps

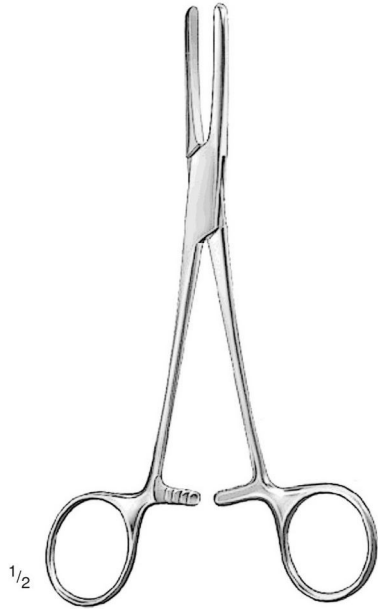

PRESBYTARIAN HOSPITAL
13.34.16 – 13.34.20



$\frac{1}{4}$
13.34.16
16 cm / 6 $\frac{1}{4}$ "



13.34.18
18 cm / 7"



13.34.20
20 cm / 8"

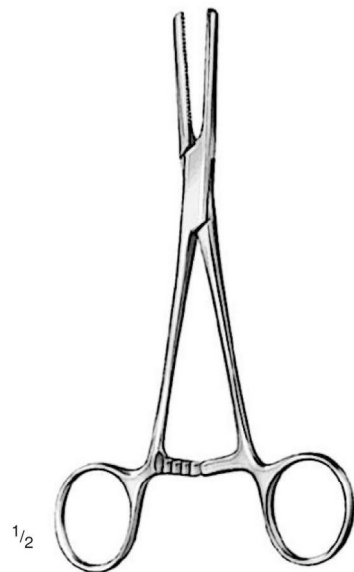

SCHOENBERG
13.35.16 – 13.35.20



$\frac{1}{4}$
13.35.16
16 cm / 6 $\frac{1}{4}$ "

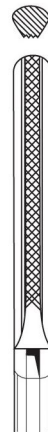

13.35.18
18 cm / 7"

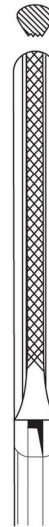

13.35.20
20 cm / 8"