

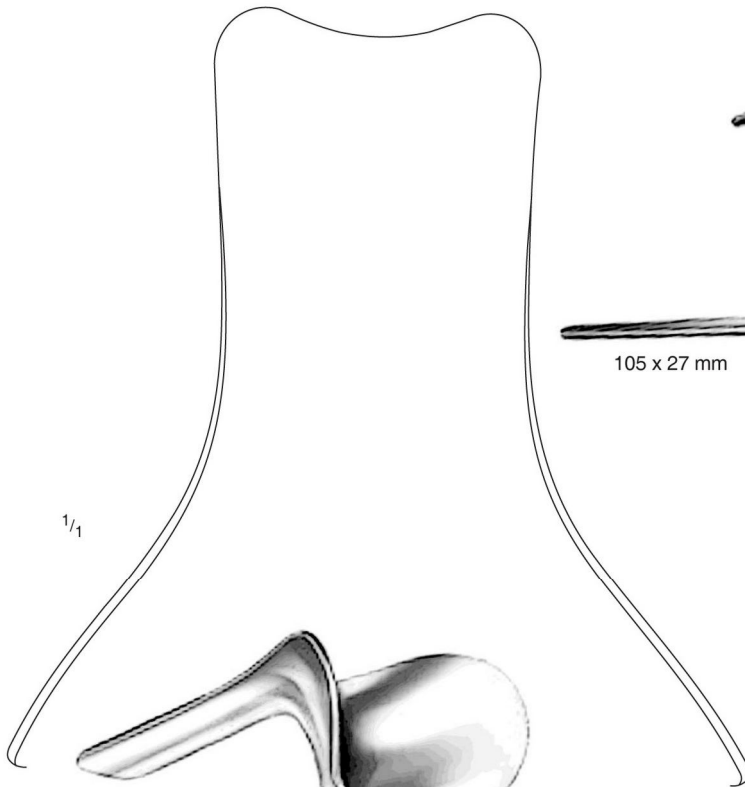

Gynecology
Ginecologia
gynecologie

Tel# 0092-52-4260785
Fax# 0092-52-4266804
Email. Info@benison.com.pk

Vaginal Specula and retractors



Complete with
removable weight

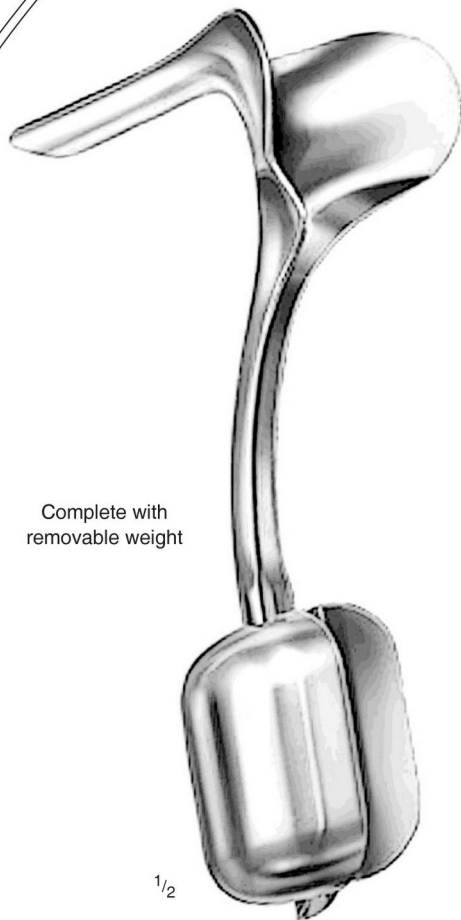

AUVARD
21.01.24
24 cm / 9 1/2"

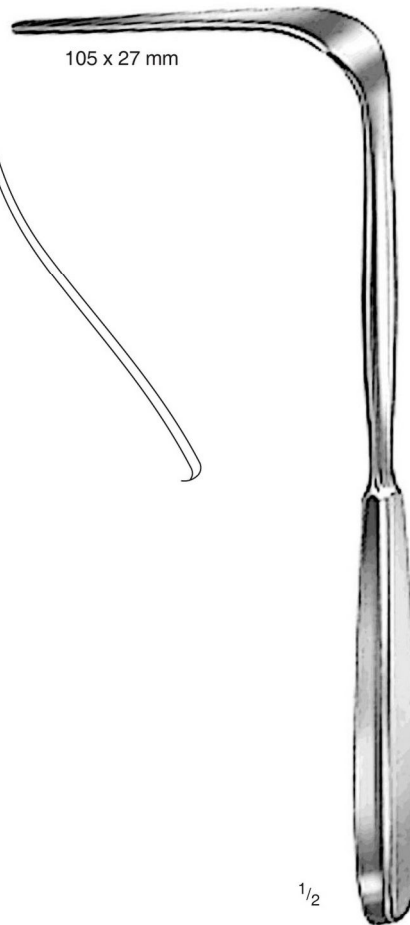

MARTIN
21.03.25
25 cm / 10"

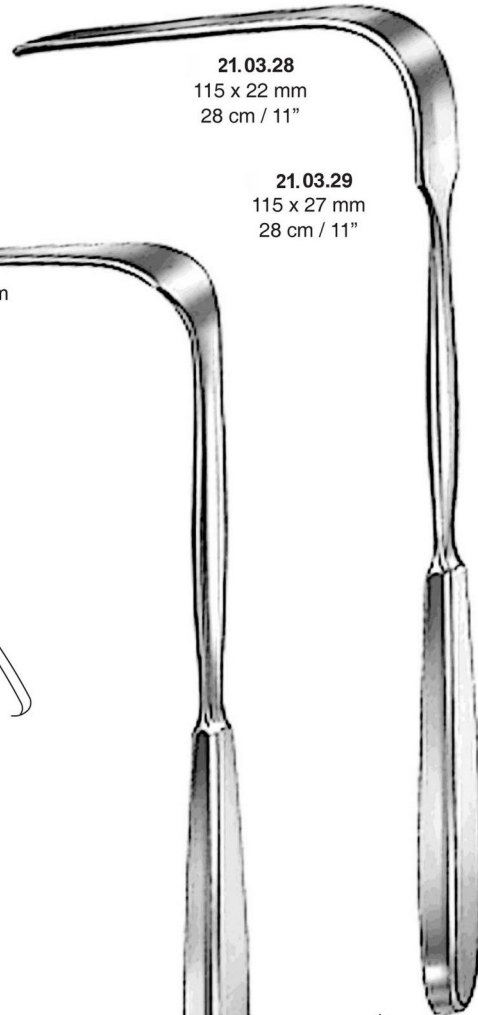

SIMON
21.03.28 - 21.03.29

Vaginal Specula and Retractors

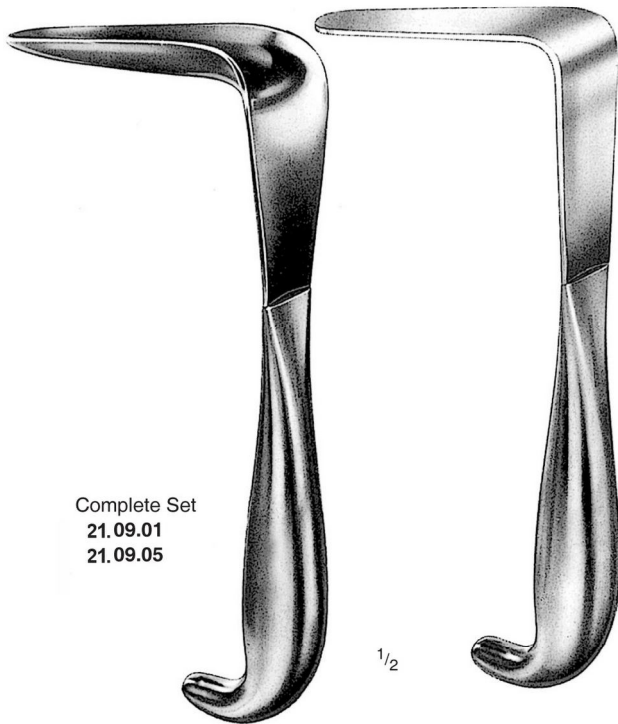

Complete Set
21.09.01
21.09.05

MATHIEU
21.09.10 – 95 x 16 - 26 mm
21.09.15 – 95 x 16 - 30 mm
Vaginal Specula

MATHIEU
21.09.25 – 100 x 11 - 20 mm
21.09.35 – 100 x 14 - 26 mm
Vaginal Retractor



1/2

KRISTELLER
Set of one Speculum
and one Retractor
21.10.27 – Fig. 1
21.10.30 – Fig. 2
21.10.36 – Fig. 3

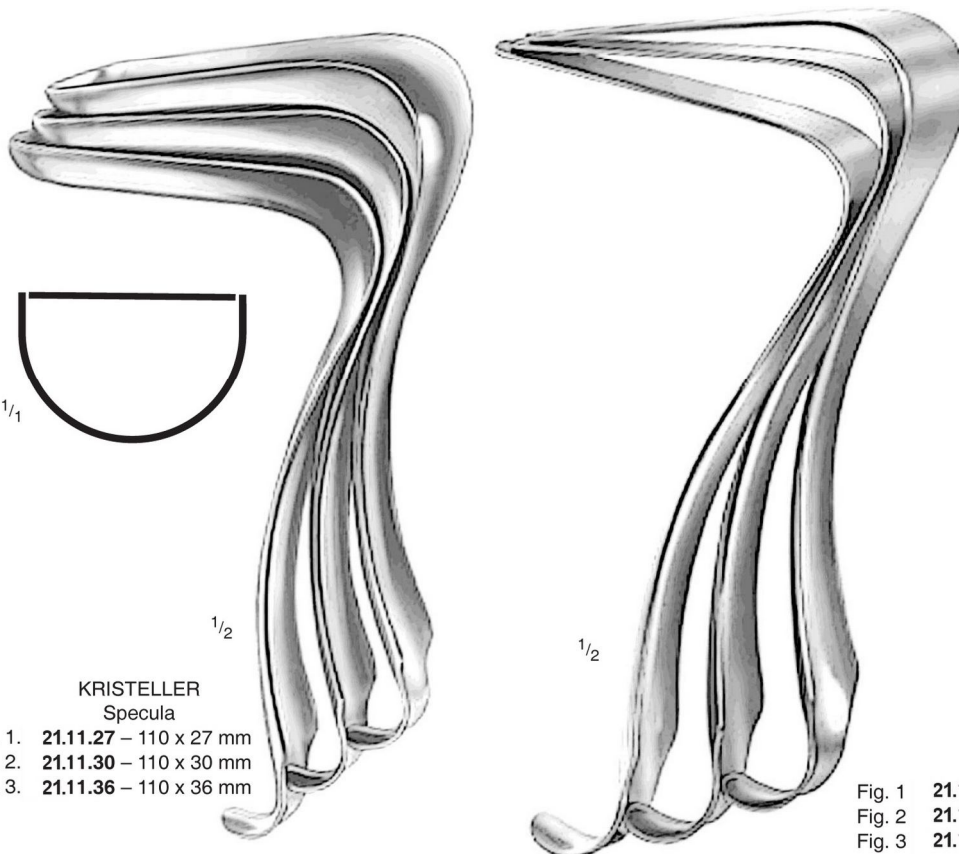

1/4

1/2

1/2

KRISTELLER
Specula

Fig. 1. 21.11.27 – 110 x 27 mm
Fig. 2. 21.11.30 – 110 x 30 mm
Fig. 3. 21.11.36 – 110 x 36 mm

KRISTELLER
Retractors

Fig. 1 21.12.23 – 115 x 23 mm
Fig. 2 21.12.26 – 115 x 26 mm
Fig. 3 21.12.32 – 115 x 32 mm

Vaginal Specula and Retractors

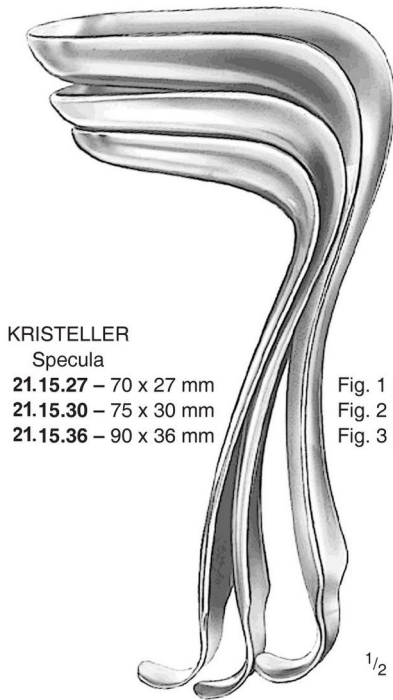

KRISTELLER
Specula

- Fig. 1 **21.15.27** – 70 x 27 mm
- Fig. 2 **21.15.30** – 75 x 30 mm
- Fig. 3 **21.15.36** – 90 x 36 mm

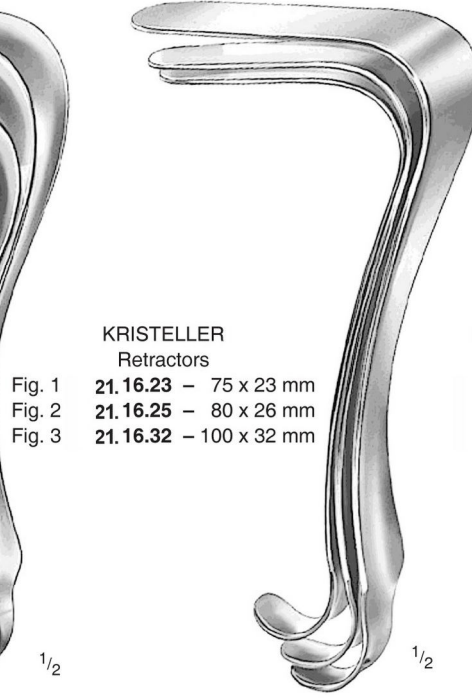

KRISTELLER
Retractors

- Fig. 1 **21.16.23** – 75 x 23 mm
- Fig. 2 **21.16.25** – 80 x 26 mm
- Fig. 3 **21.16.32** – 100 x 32 mm

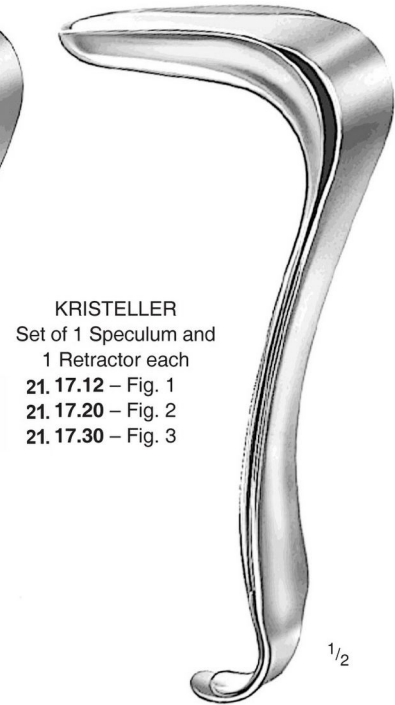

KRISTELLER
Set of 1 Speculum and
1 Retractor each

- 21.17.12** – Fig. 1
- 21.17.20** – Fig. 2
- 21.17.30** – Fig. 3

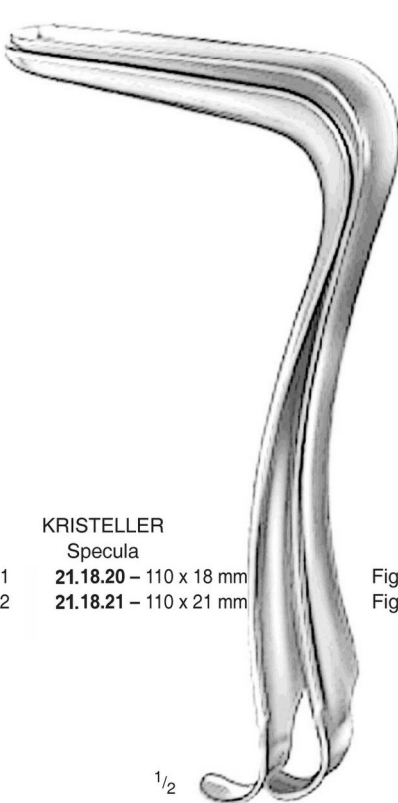

KRISTELLER
Specula

- Fig. 1 **21.18.20** – 110 x 18 mm
- Fig. 2 **21.18.21** – 110 x 21 mm



KRISTELLER
Retractors

- Fig. 1 **21.18.25** – 115 x 14 mm
- Fig. 2 **21.18.26** – 115 x 17 mm



KRISTELLER
Set of 1 Speculum
and 1 Retractor each

- 21.18.30** – Fig. 1
- 21.18.31** – Fig. 2

Vaginal Specula and Retractors

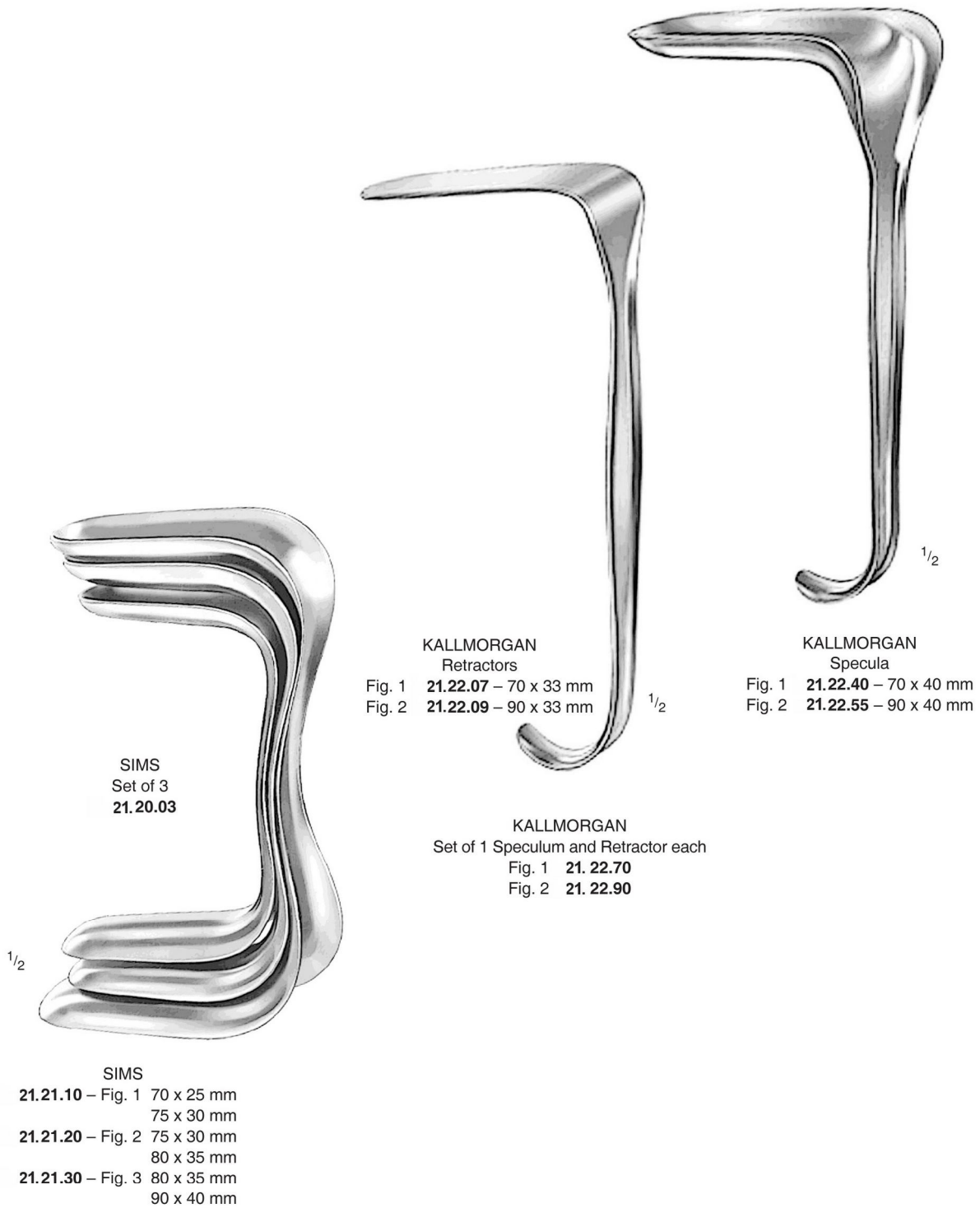

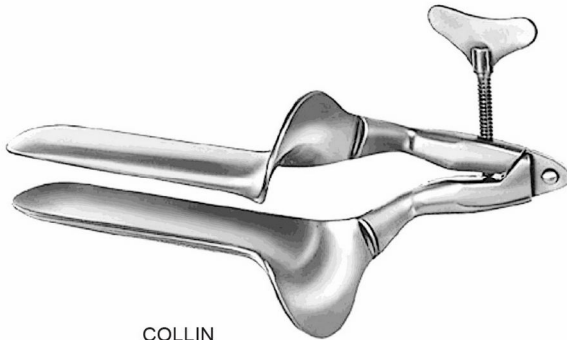
Vaginal Specula and Retractors

COLLIN

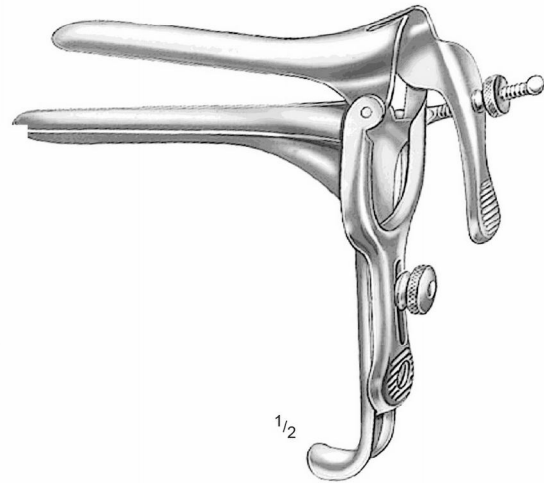
- 21. 23.25 – 90 x 25 mm
- 21. 23.29 – 90 x 29 mm
- 21. 23.35 – 100 x 35 mm
- 21. 23.40 – 100 x 40 mm
- 21. 23.36 – 110 x 36 mm
- 21. 23.41 – 110 x 40 mm

PEDERSON

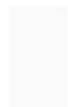
- 21. 29.13 – 76 x 13 mm
- 21. 29.22 – 100 x 22 mm
- 21. 29.25 – 120 x 25 mm



60 x 30 mm

- 21. 35.02 – 100 x 20 mm
- 21. 35.04 – 100 x 25 mm
- 21. 35.06 – 100 x 30 mm
- 21. 35.08 – 100 x 35 mm
- 21. 35.10 – 100 x 40 mm

- 21. 36.02 – 130 x 20 mm
- 21. 36.04 – 130 x 25 mm
- 21. 36.06 – 130 x 30 mm
- 21. 36.08 – 130 x 35 mm
- 21. 36.10 – 130 x 40 mm

BRIESKY

- 21. 35.02 – 21. 36.10
- 27 - 30 cm / 10 ³/₄" – 11 ³/₄"

1/3

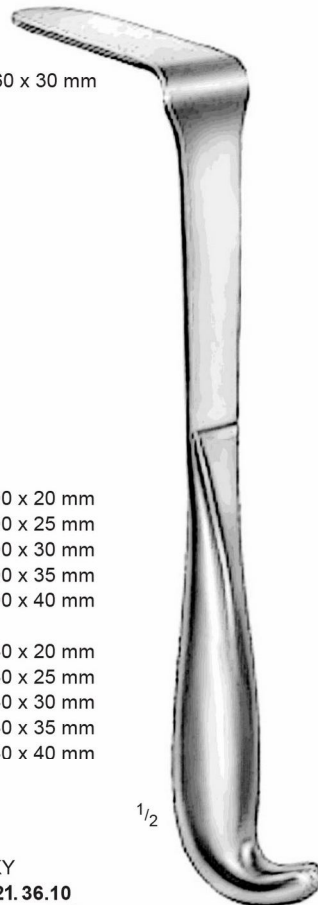

1/2

DOYEN
 21. 06.23
 23 cm / 9"

GRAVES

- 21. 30.20 – 75 x 20 mm
- 21. 30.30 – 100 x 30 mm
- 21. 30.35 – 115 x 35 mm

Vaginal Specula

Central Fixation Screw

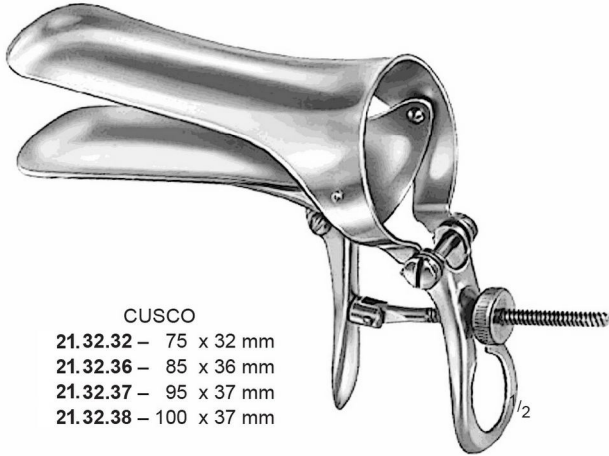

CUSCO
21.32.32 – 75 x 32 mm
21.32.36 – 85 x 36 mm
21.32.37 – 95 x 37 mm
21.32.38 – 100 x 37 mm

For Virgins

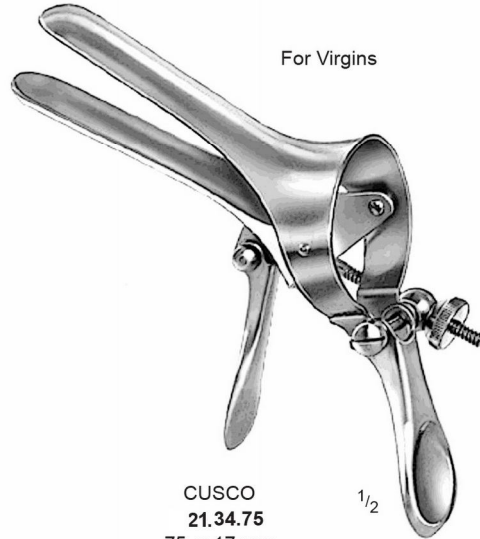

CUSCO
21.34.75
75 x 17 mm

Swiss Pattern

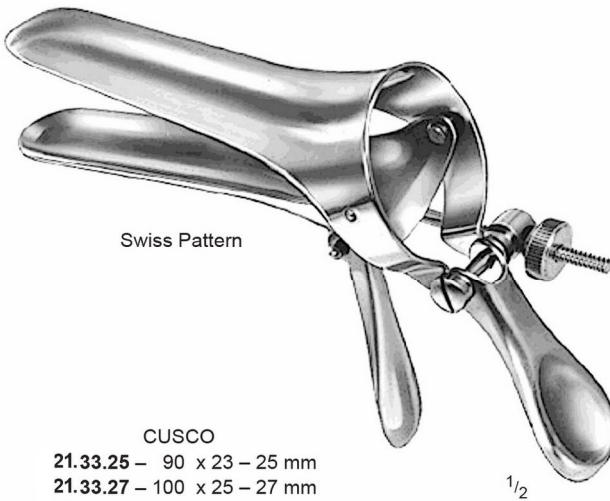

CUSCO
21.33.25 – 90 x 23 – 25 mm
21.33.27 – 100 x 25 – 27 mm
21.33.30 – 110 x 27 – 30 mm

Lateral Fixation Screw

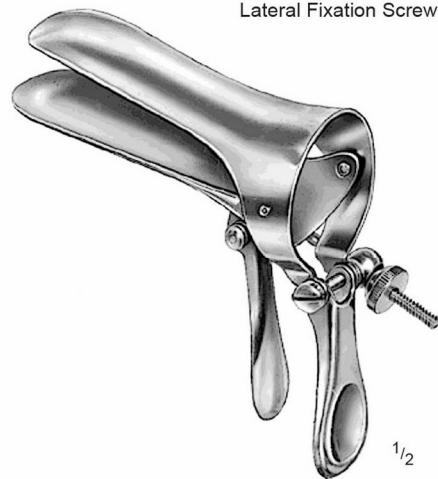

CUSCO
21.34.32 – 75 x 32 mm
21.34.36 – 85 x 36 mm
21.34.37 – 95 x 37 mm
21.34.38 – 100 x 35 mm

Uterine Dilators

With Sloped Handle

mm Ø

1	21.38.01	
1.5		21.39.01
2	21.38.02	
2.5		21.39.02
3	21.38.03	
3.5		21.39.03
4	21.38.04	
4.5		21.39.04
5	21.38.05	
5.5		21.39.05
6	21.38.06	
6.5		21.39.06
7	21.38.07	
7.5		21.39.07
8	21.38.08	
8.5		21.39.08
9	21.38.09	
9.5		21.39.09
10	21.38.10	
10.5		21.39.10
11	21.38.11	
11.5		21.39.11
12	21.38.12	
12.5		21.39.12
13	21.38.13	
13.5		21.39.13
14	21.38.14	
14.5		21.39.14
15	21.38.15	
15.5		21.39.15
16	21.38.16	
16.5		21.39.16
17	21.38.17	
17.5		21.39.17
18	21.38.18	
18.5		21.39.18
19	21.38.19	
19.5		21.39.19
20	21.38.20	
20.5		21.39.20
21	21.38.21	
22	21.38.22	
23	21.38.23	
24	21.38.24	
25	21.38.25	
26	21.38.26	



HEGAR
21.38.01 - 21.38.26
21.39.01 - 21.39.20

Uterine Dilators

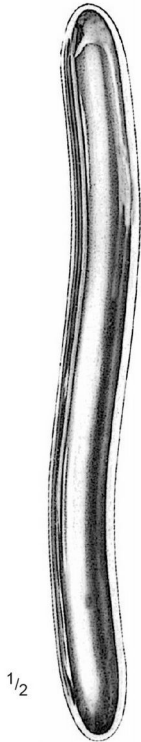

HEGAR

mmø

1 + 2 mm	21.40.01
3 + 4 mm	21.40.03
5 + 6 mm	21.40.05
7 + 8 mm	21.40.07
9 + 10 mm	21.40.09
11 + 12 mm	21.40.11
13 + 14 mm	21.40.13
15 + 16 mm	21.40.15
17 + 18 mm	21.40.17
19 + 20 mm	21.40.19
21 + 22 mm	21.40.21
23 + 24 mm	21.40.23
25 + 26 mm	21.40.25

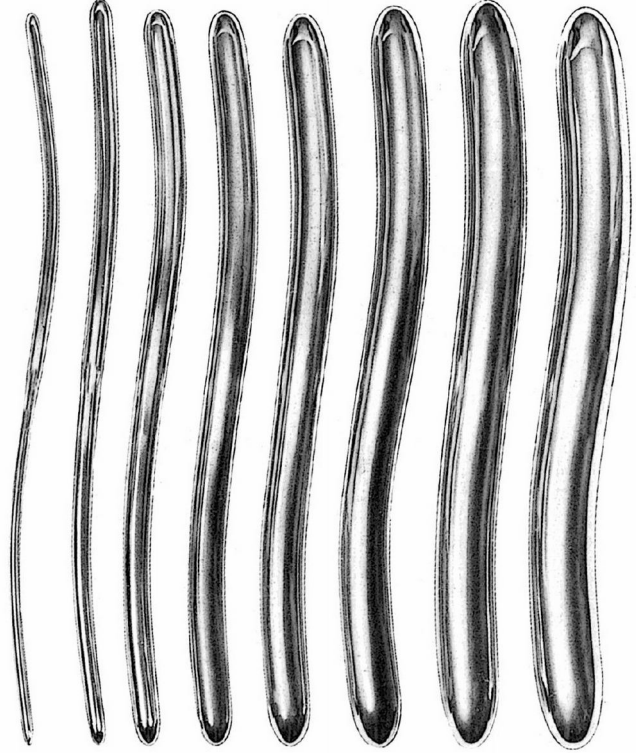

21.40.42
Set of 8 dilators, 3 + 4mm – 17 + 18 mm,
in canvas roll.

Uterine Dilators



1/2

HANK

21.40.50 - 21.40.60

ø mm

- 21.40.50 - Fig. 9/10 = 4.5 / 5 mm
- 21.40.52 - Fig. 11/12 = 5.5 / 6 mm
- 21.40.54 - Fig. 13/14 = 6.5 / 7 mm
- 21.40.56 - Fig. 15/16 = 7.5 / 8 mm
- 21.40.58 - Fig. 17/18 = 8.5 / 9 mm
- 21.40.60 - Fig. 19/20 = 9.5 / 10 mm

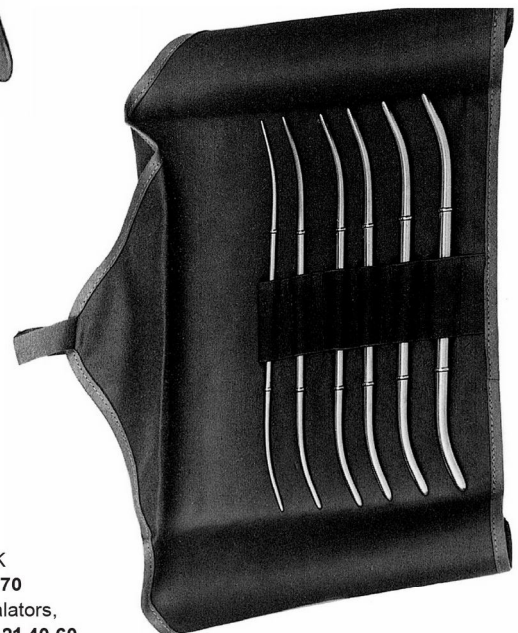

HANK
21.40.70

Set of 6 Dialators,
21.40.50 - 21.40.60

Endocervical Specula, Uterine Sounds, Depressors

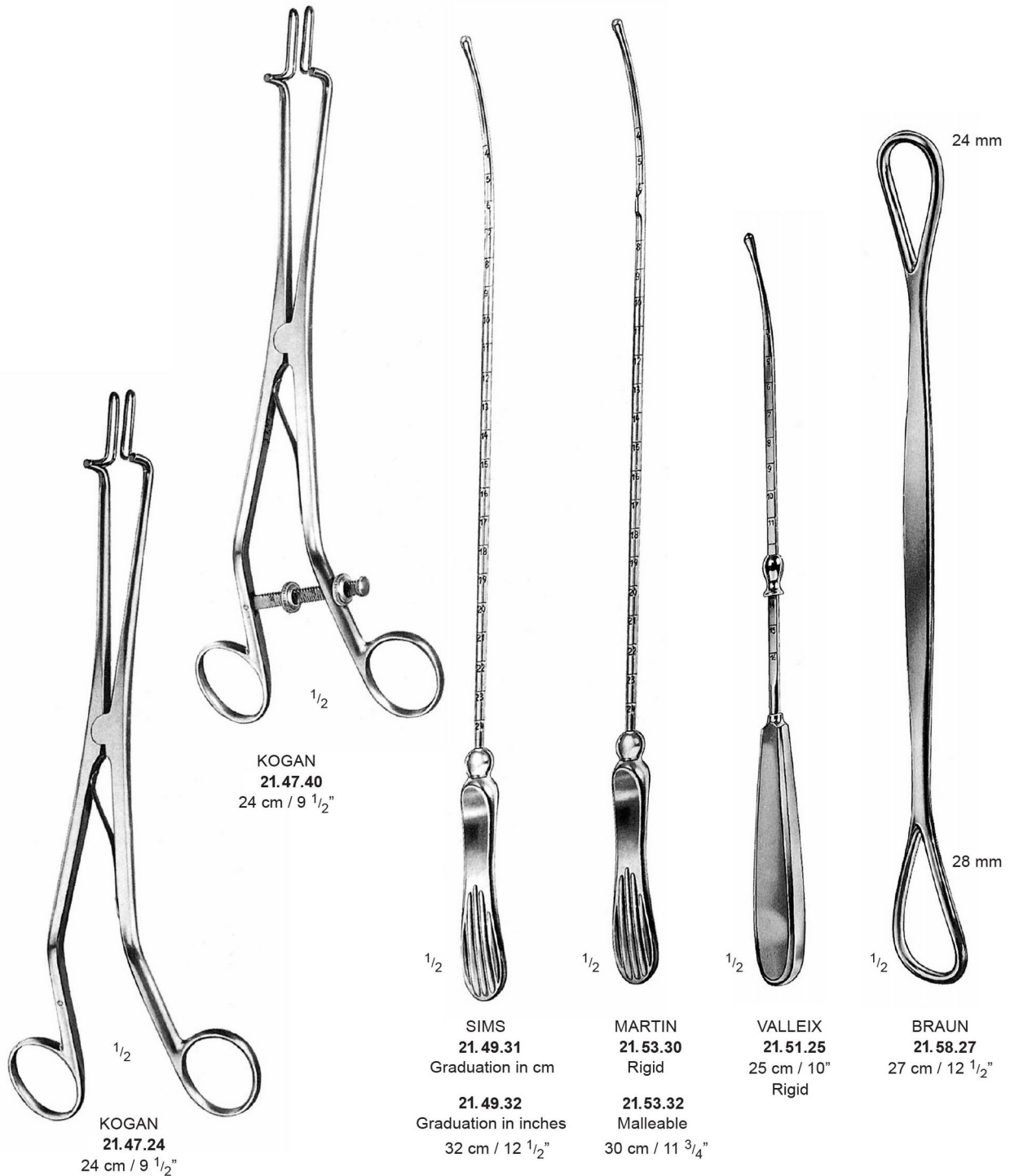

Tenaculum Forceps

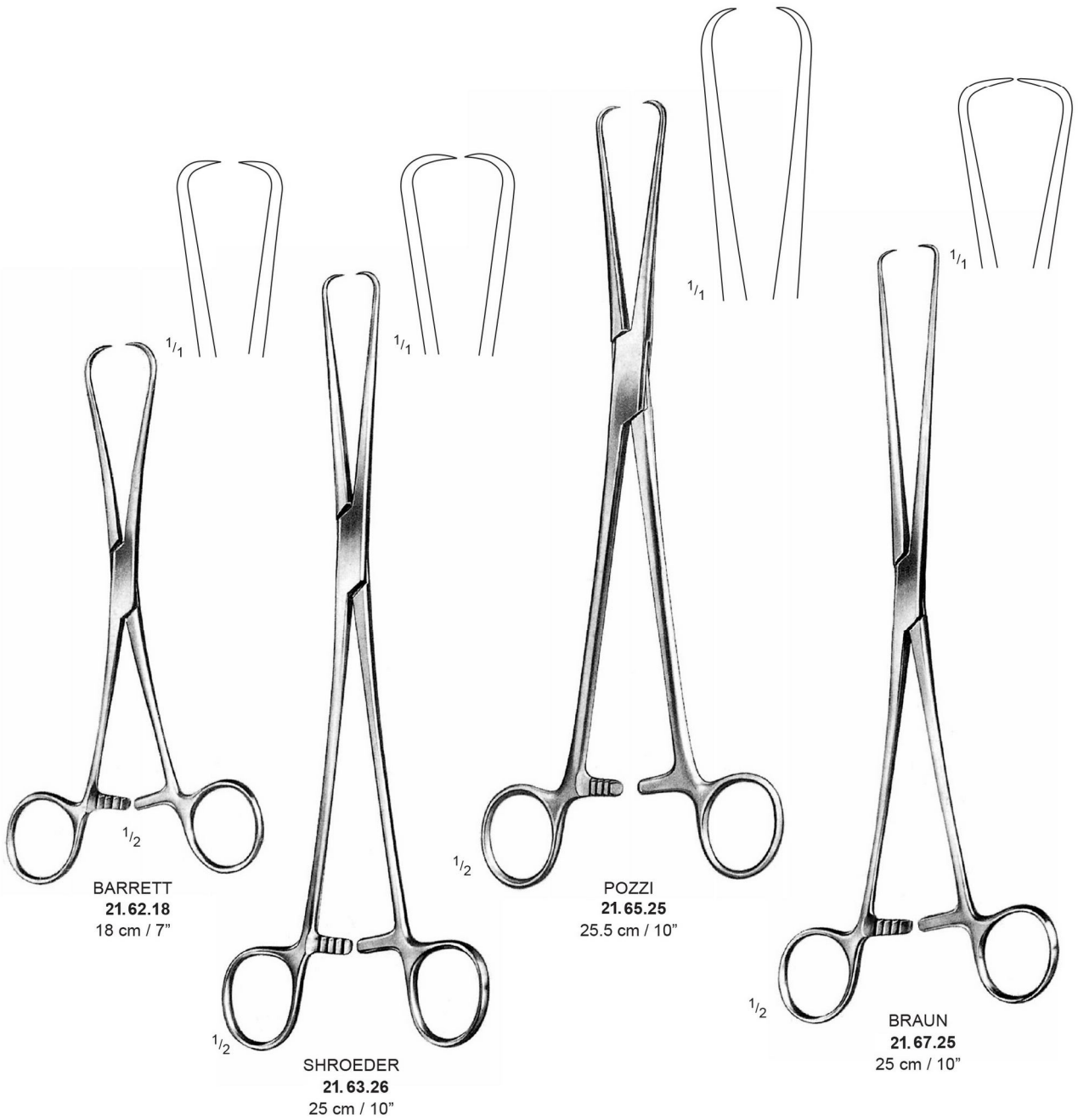

Tenaculum Forceps

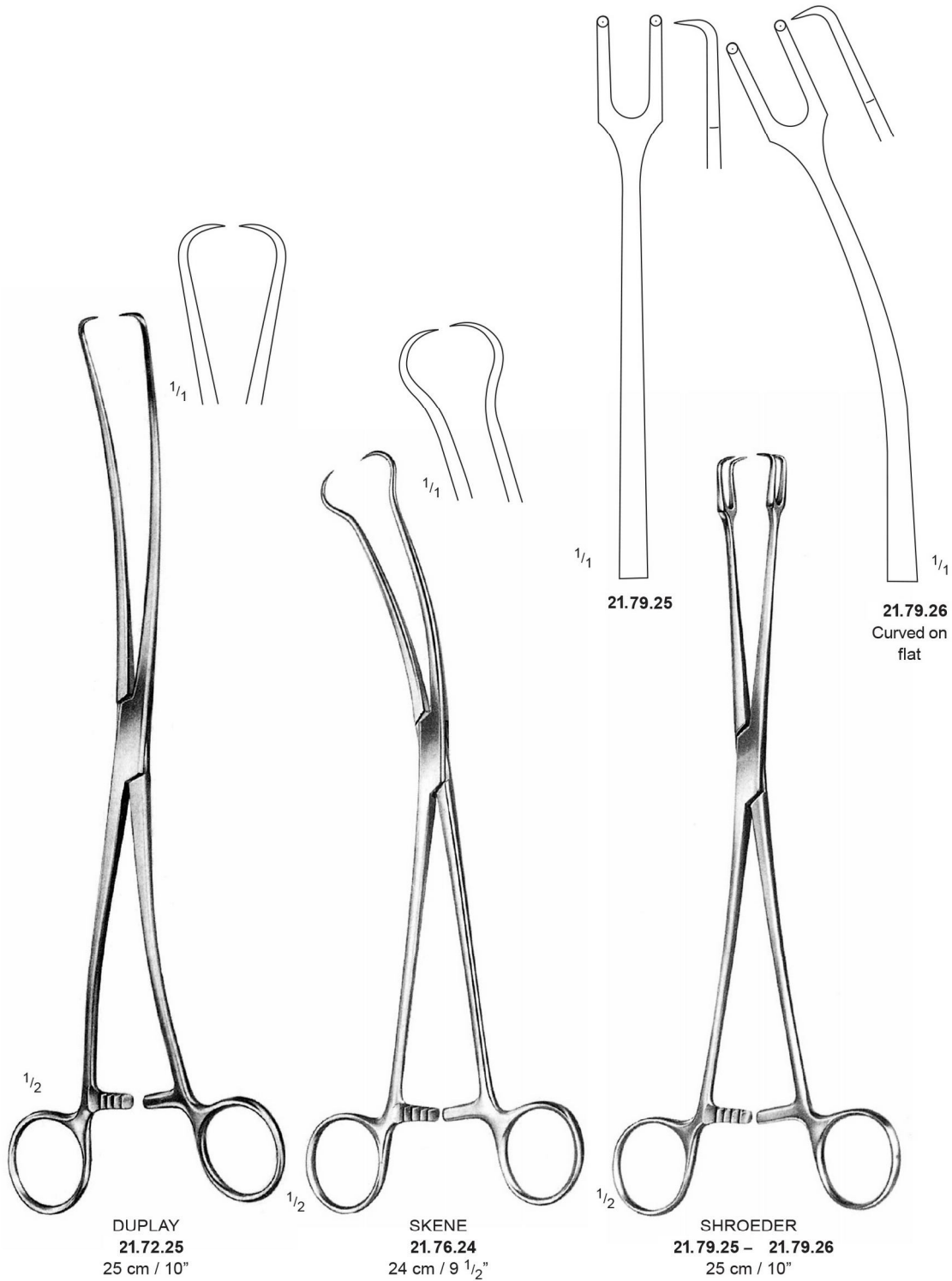

Vulsellum Forceps

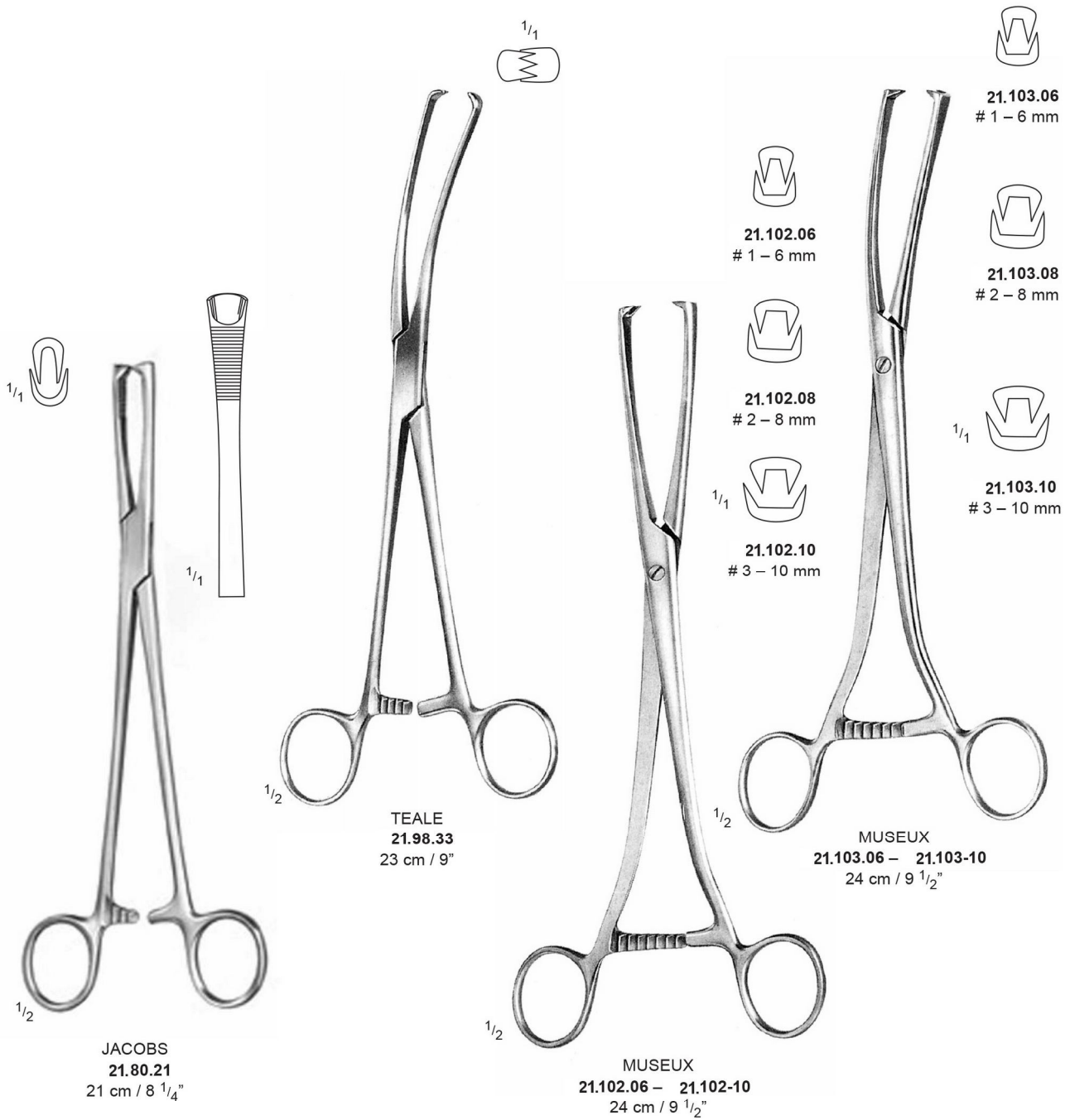

Ovary and Polypus seizing Forceps



Uterine Elevating Forceps

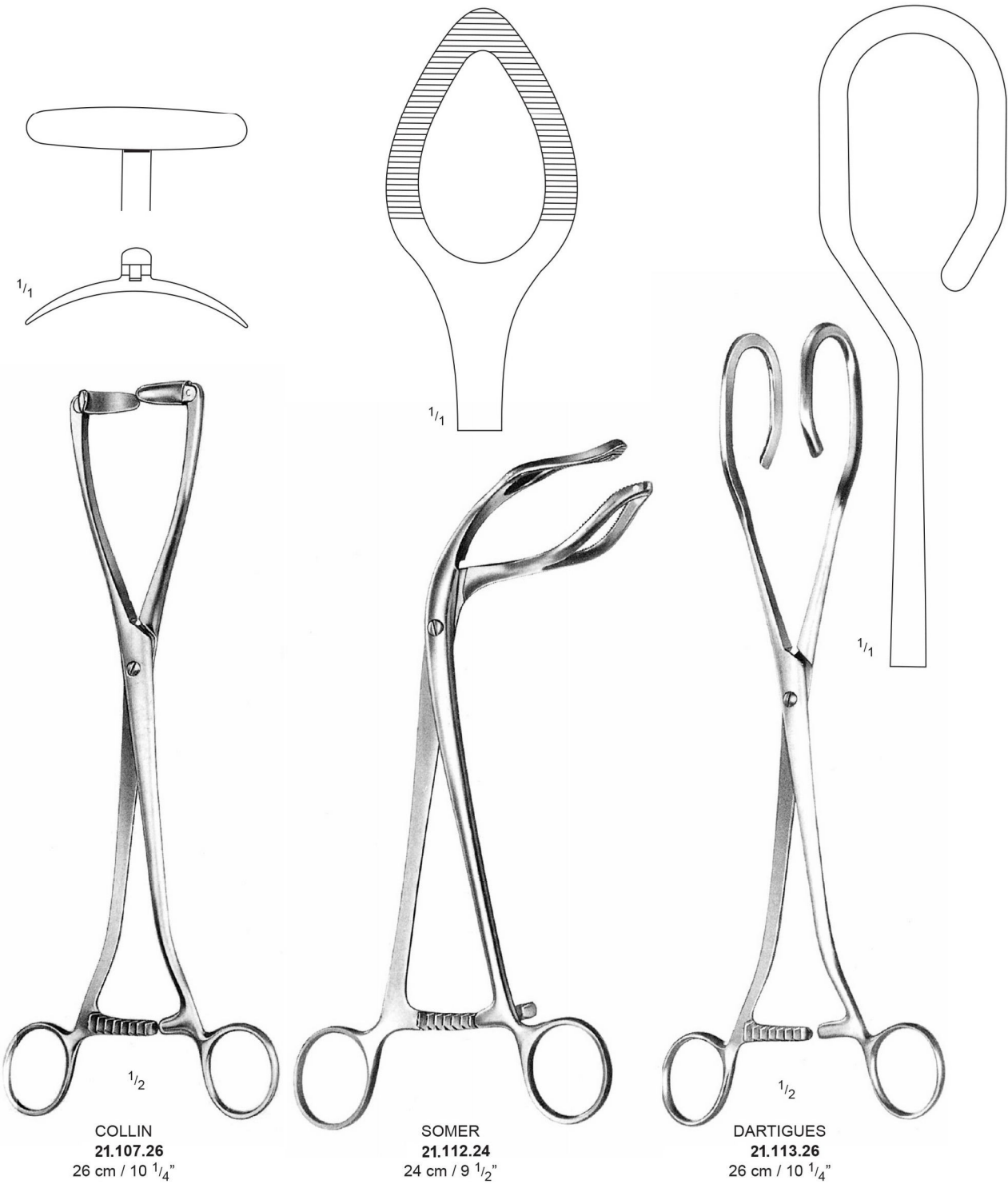

Cervical Biopsy Forceps



THOMS - GAYLOR
21.123.24
24 cm / 9 1/2"

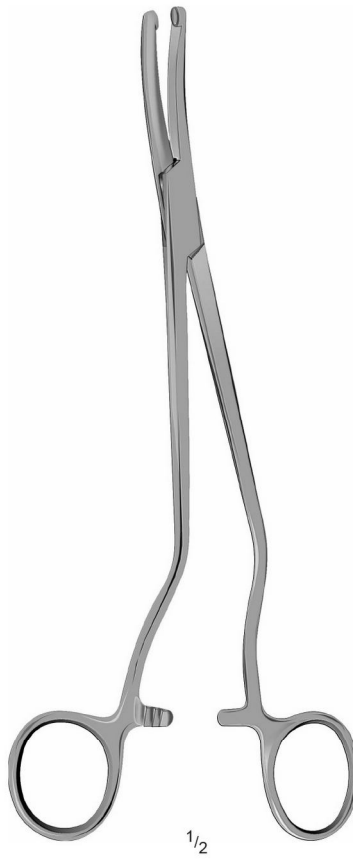

PROFESSOR MEDINA
21.124.22
22 cm / 8 3/4"

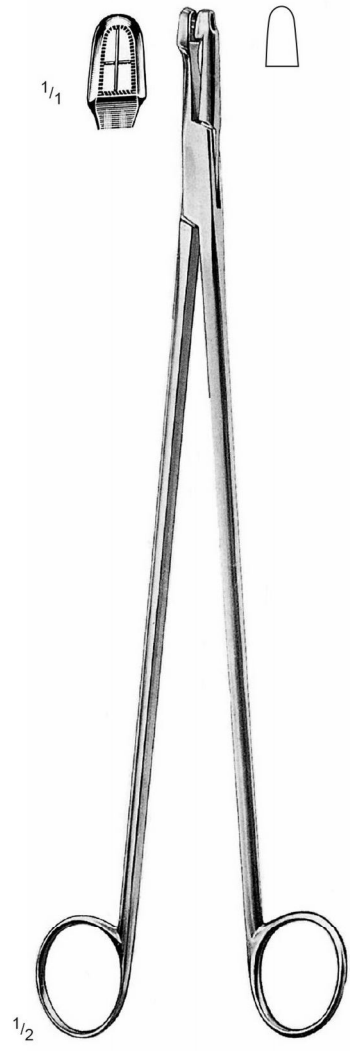

SCHUBERT
21.125.21
21 cm / 8 1/4"

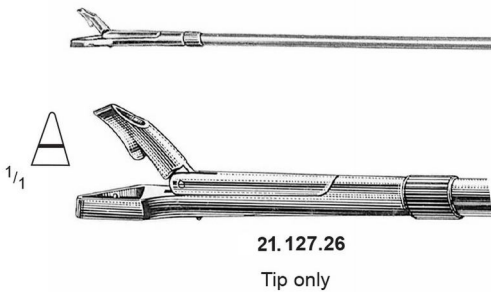

21.127.26
Tip only

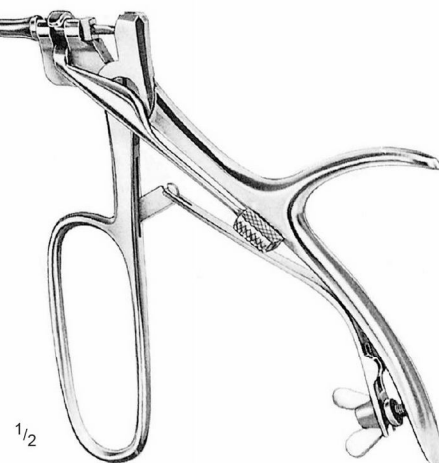

SCHUMACHER
21.127.30

Cervical Biopsy Forceps

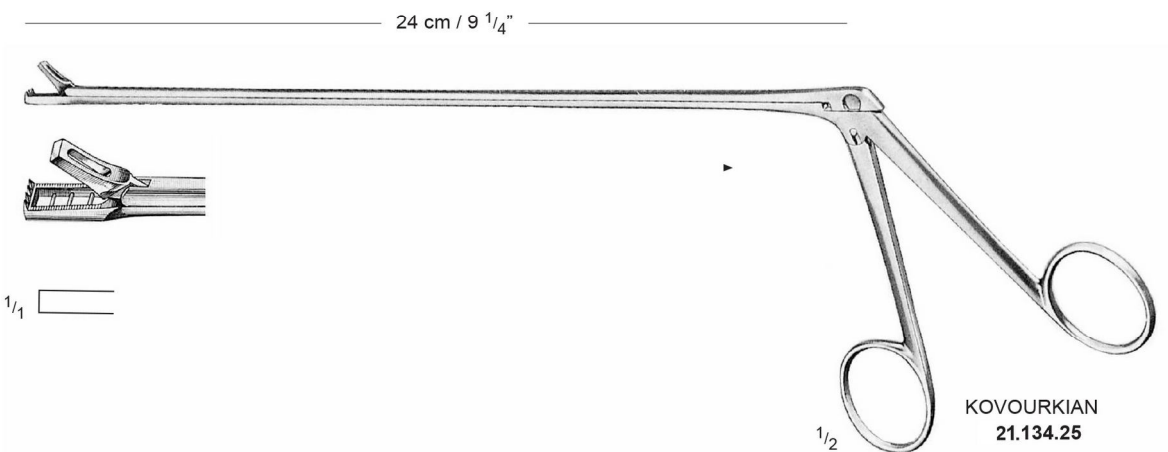
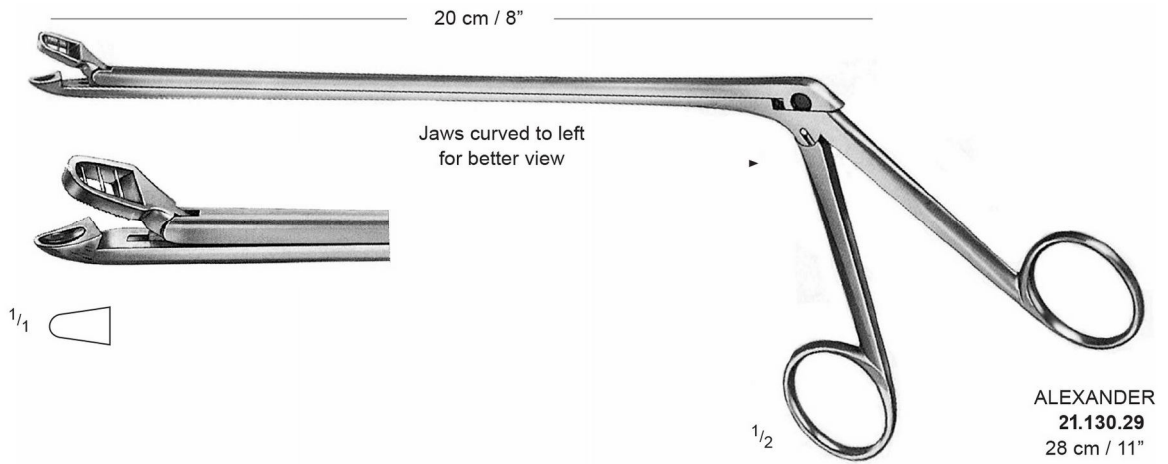
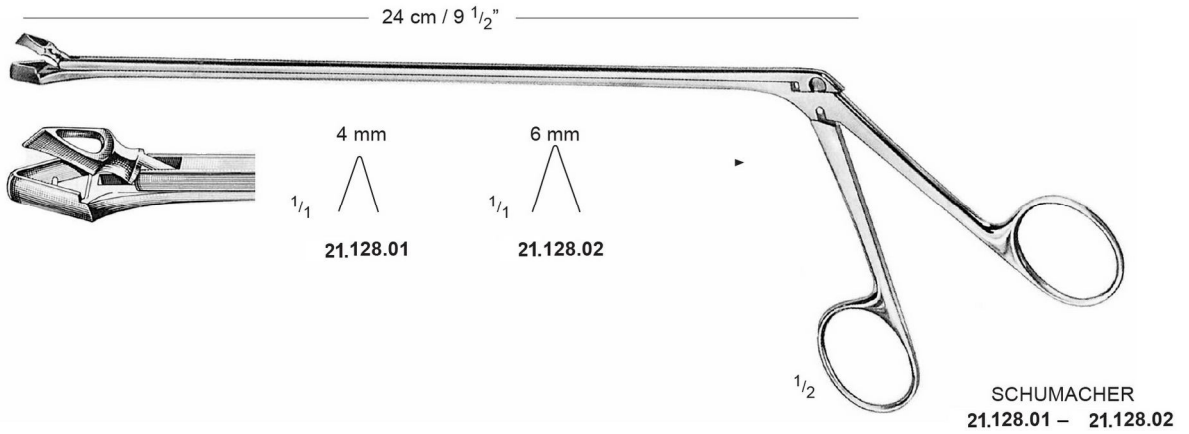

Myoma Screws, Suction Biopsy Curettes

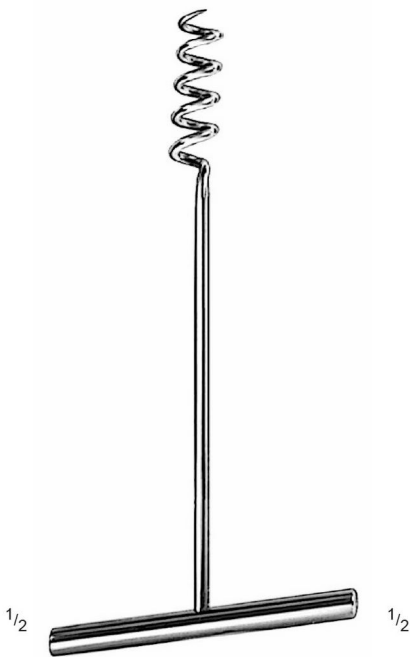

DOYEN
21.136.20
17 cm / 6 3/4"
ø 20 mm

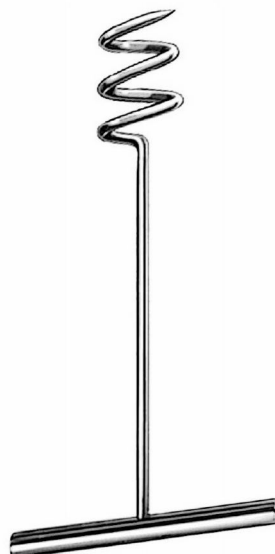

DOYEN
21.136.29
14 cm / 5 1/2"
ø 29 mm

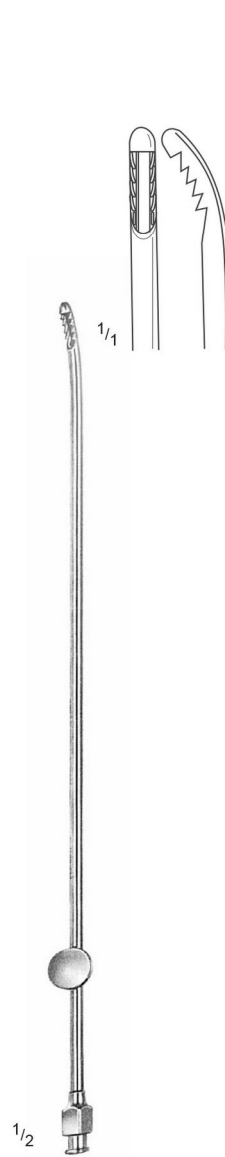

NOVAK
21.138.23
23 cm / 9"

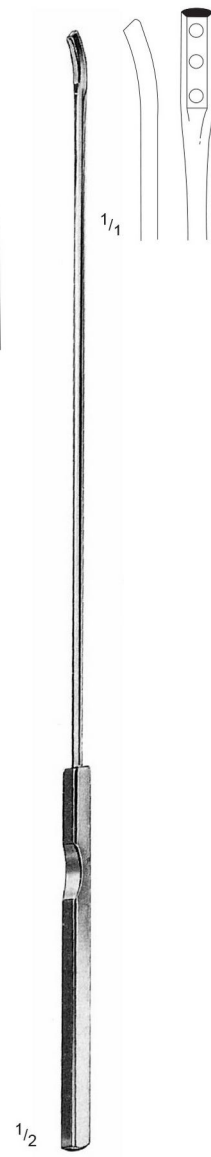

KOVOURKIAN-YOUNG
21.139.30
30 cm / 12"

Uterine Scoops

		21.146.07 # 1 – 7 mm			21.148.01 #1 - 7 mm
		21.146.08 # 2 – 8 mm			21.148.02 # 2 - 8 mm
		21.146.10 # 3 – 10 mm			21.148.03 # 3 - 10 mm
		21.146.11 # 4 – 11 mm			21.148.04 # 4 - 11 mm
		21.146.12 # 5 – 12 mm			21.148.05 # 5 - 12 mm
		21.146.15 # 6 – 15 mm			21.148.06 # 6 - 15 mm
$\frac{1}{2}$			$\frac{1}{2}$		
<p>SIMON 21.146.07 – 21.146.15 29 cm / 11 $\frac{1}{2}$" Rigid, Sharp</p>			<p>SCHROEDER 21.148.01 - 21.148.06 30 cm / 12" Rigid, Sharp</p>		

Uterine Curettes

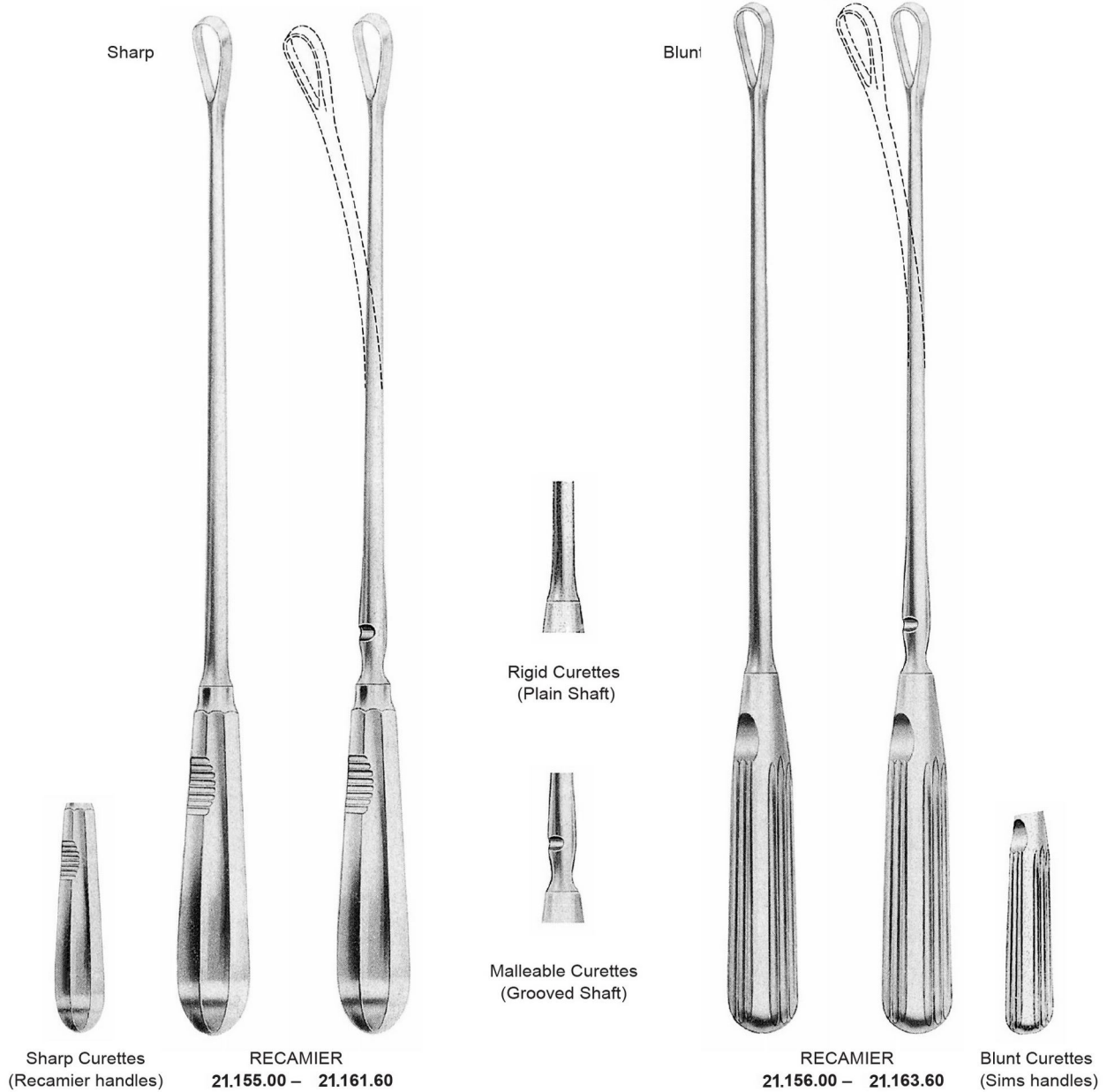

Rigid	Malleable
21.155.00 – Fig 00- 5 mm –	–
21.155.10 – Fig 0- 6 mm –	21.155.26
21.155.11 – Fig 1- 7 mm –	21.155.27
21.155.12 – Fig 2- 8 mm –	21.155.28
21.155.13 – Fig 3- 9 mm –	21.155.29
21.155.14 – Fig 4- 11 mm –	21.155.31
21.155.15 – Fig 5- 12 mm –	21.155.32
21.155.16 – Fig 6- 14 mm –	21.155.34
21.155.17 – Fig 7- 15 mm –	21.155.35
21.155.18 – Fig 8- 16 mm –	21.155.36
21.155.19 – Fig 9- 19 mm –	21.155.39
21.155.20 – Fig 10-20 mm –	21.155.40
21.155.21 – Fig 11-21 mm –	21.155.41
21.155.23 – Fig 12-23 mm –	21.155.43
21.155.25 – Fig 13-25 mm –	21.155.45
21.160.30 – Fig 14-30 mm –	21.161.50
21.160.35 – Fig 15-35 mm –	21.161.55
21.160.40 – Fig 16-40 mm –	21.161.60

Rigid	Malleable
21.156.00 – Fig 00- 5 mm –	–
21.156.10 – Fig 0- 6 mm –	21.156.26
21.156.11 – Fig 1- 7 mm –	21.156.27
21.156.12 – Fig 2- 8 mm –	21.156.28
21.156.13 – Fig 3- 9 mm –	21.156.29
21.156.14 – Fig 4- 11 mm –	21.156.31
21.156.15 – Fig 5- 12 mm –	21.156.32
21.156.16 – Fig 6- 14 mm –	21.156.34
21.156.17 – Fig 7- 15 mm –	21.156.35
21.156.18 – Fig 8- 16 mm –	21.156.36
21.156.19 – Fig 9- 19 mm –	21.156.39
21.156.20 – Fig 10-20 mm –	21.156.40
21.156.21 – Fig 11-21 mm –	21.156.41
21.156.23 – Fig 12-23 mm –	21.156.43
21.156.25 – Fig 13-25 mm –	21.156.45
21.162.30 – Fig 14-30 mm –	21.163.50
21.162.35 – Fig 15-35 mm –	21.163.55
21.162.40 – Fig 16-40 mm –	21.163.60

Uterine Curettes

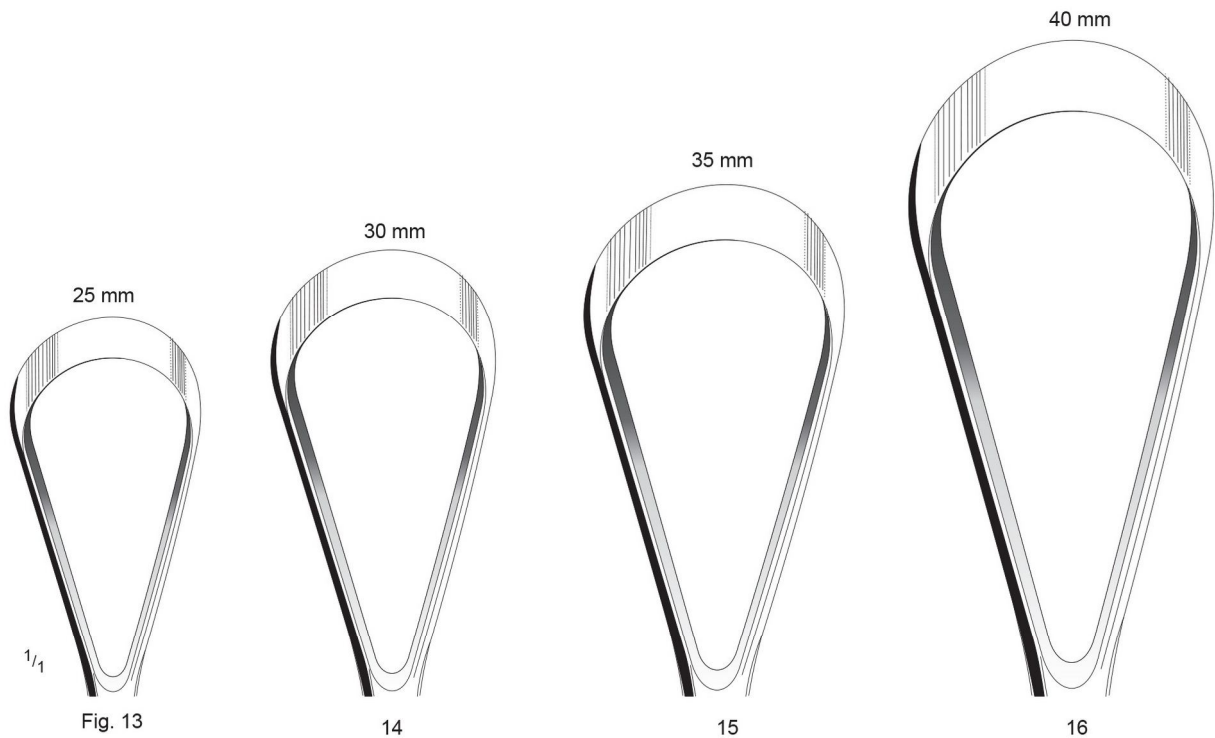
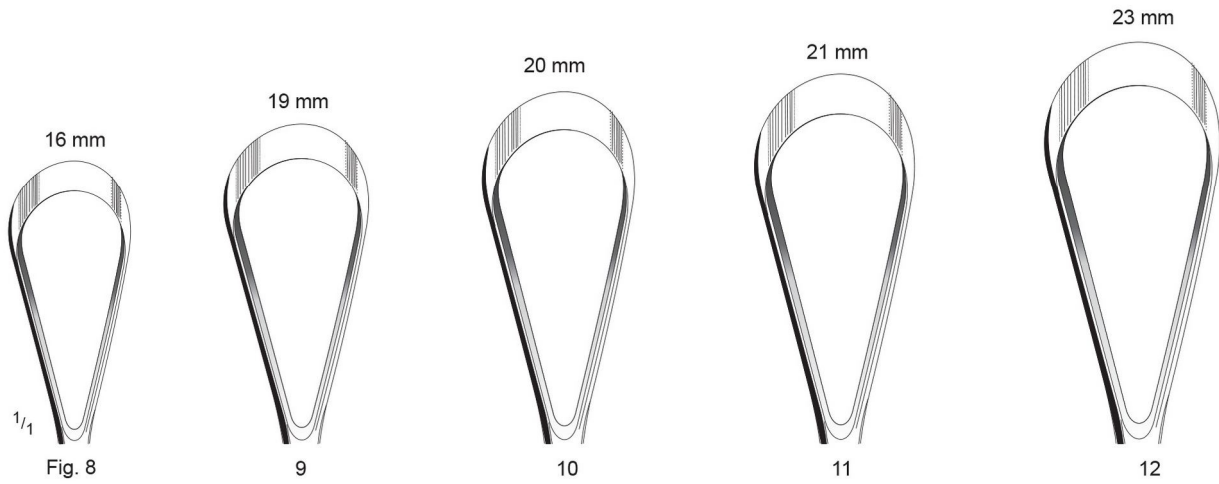
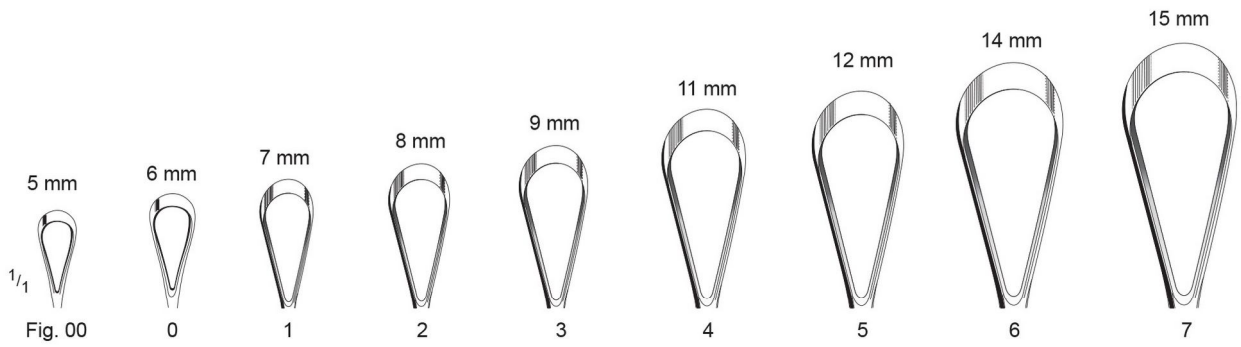

Pelvimetre, Amnitome, Scalp Flap Forceps, Obstetrical Forceps



1/4

MARTIN
21.03.35
34 cm / 13 1/2"
cm scale

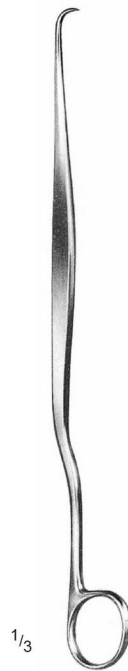

1/3

BEACHAM
21.06.24
24 cm / 9 1/2"

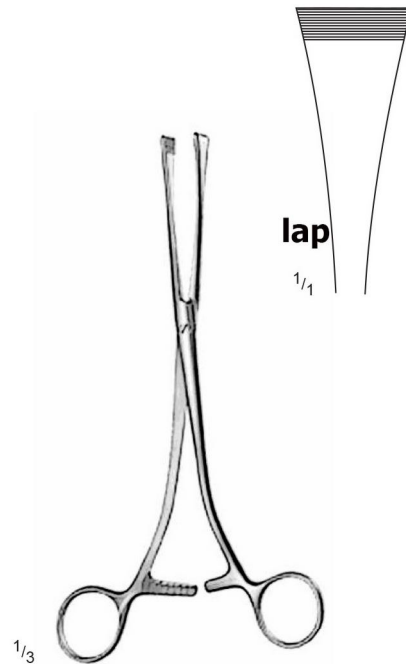

1/3

GREEN ARMYTAGE
21.09.22
22 cm / 8 3/4"



1/4

DeLEE
21.12.36
36 cm / 14 1/4"

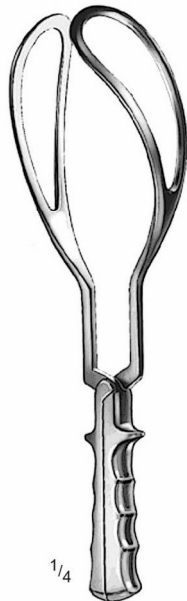

1/4

SIMPSON
21.13.32 – 32 cm / 12 1/2"
21.13.36 – 36 cm / 14 1/4"

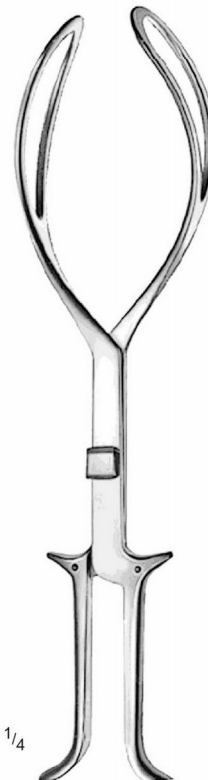

1/4

KIELLAND
21.17.40
40 cm / 15 3/4"

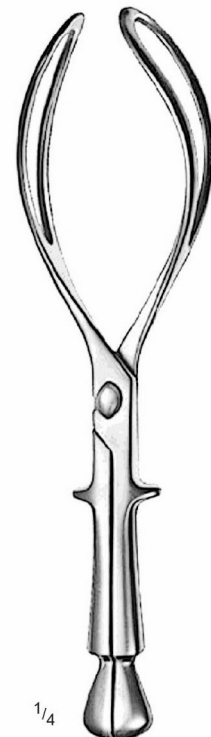

1/4

NAEGELE
21.23.35 – 36 cm / 14"
21.23.40 – 40 cm / 15 3/4"

Episiotomy Scissors, Umbilical Cord Scissors

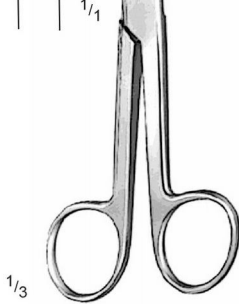
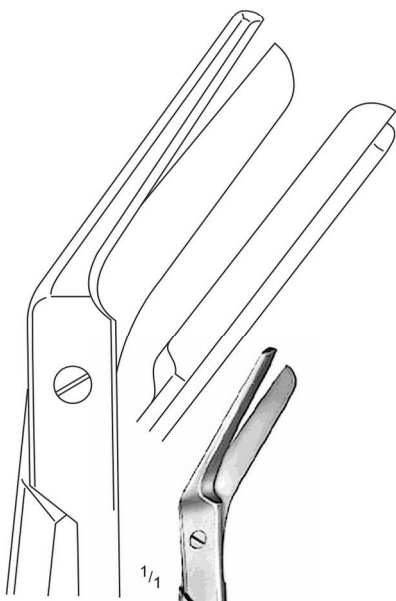

1/3

BRAUN STADLER
21.20.15
15 cm / 6"

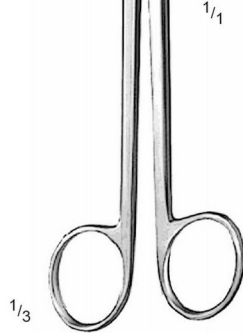

1/3

BRAUN STADLER
21.20.21
21 cm / 8 1/4"

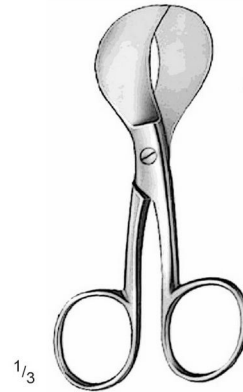
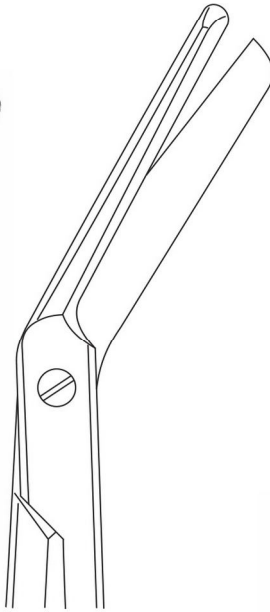

1/3

USA PATTERN
21.32.11
10.5 cm / 4 1/4"

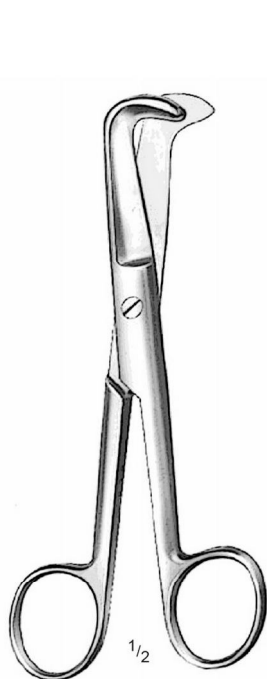
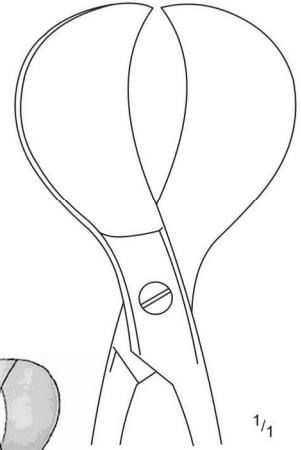

1/2

SCHUMACHER
21.33.16
16 cm / 6 1/4"

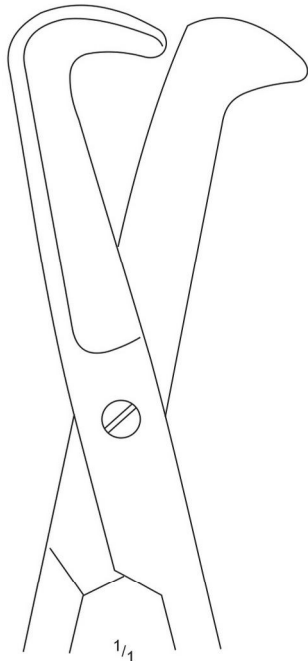

1/1

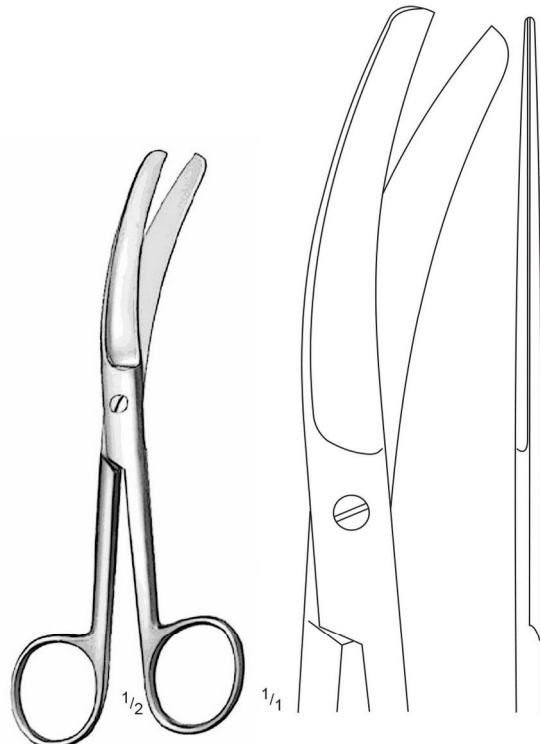

1/2

BUSCH
21.34.16
16 cm / 6 1/4"

Elevating Spoon, Cord Clamps, Placenta Forceps



SELHEIM
21.25.28
28 cm / 11"

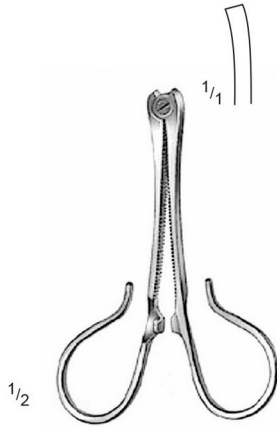

KANE
21.35.09
8.5 cm / 3 1/2"



COLLIN
21.36.09
9 cm / 3 1/2"

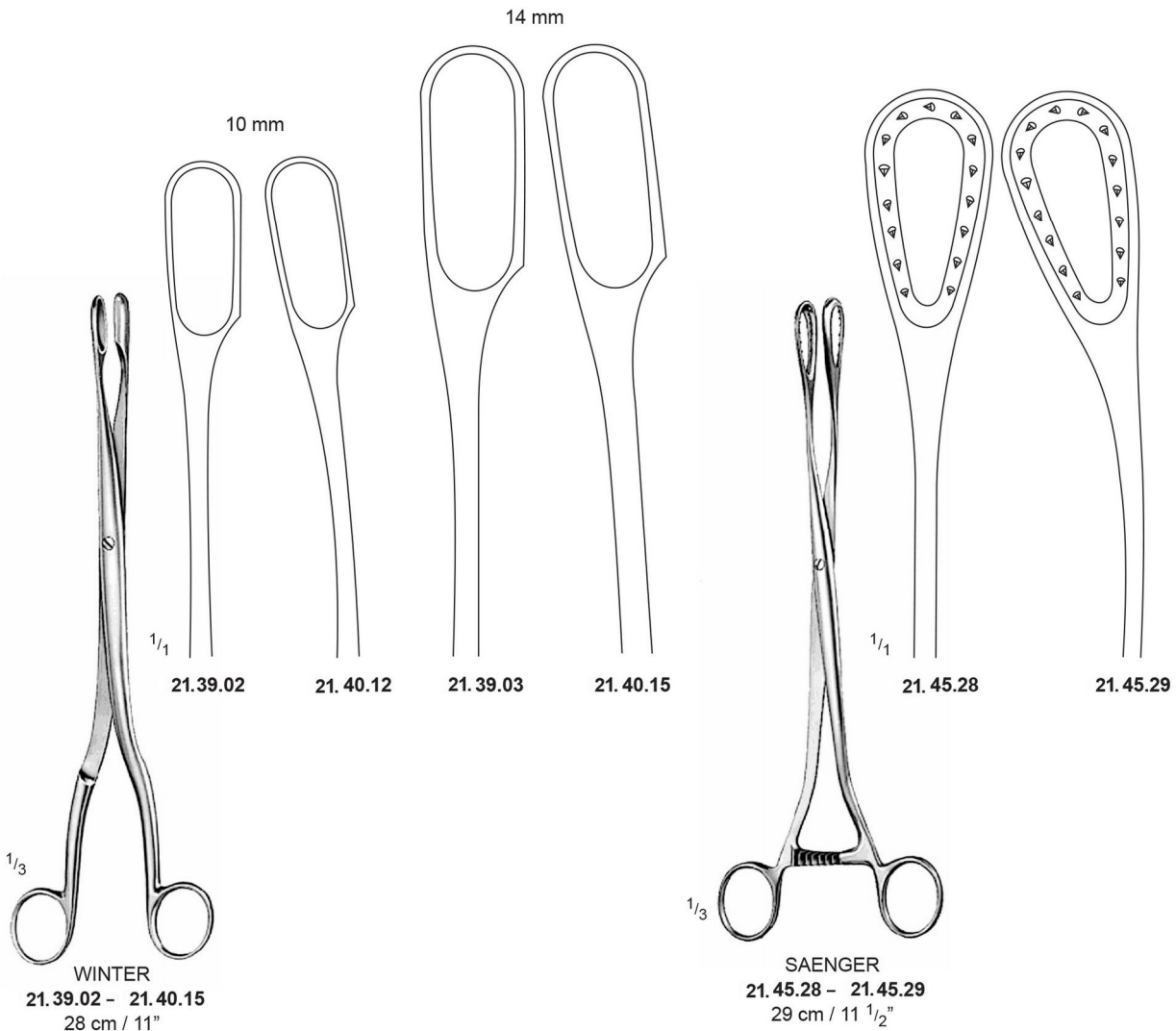

WINTER
21.39.02 - 21.40.15
28 cm / 11"

SAENGER
21.45.28 - 21.45.29
29 cm / 11 1/2"