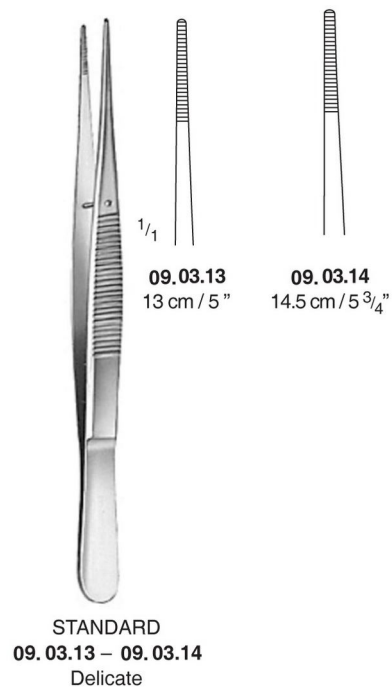
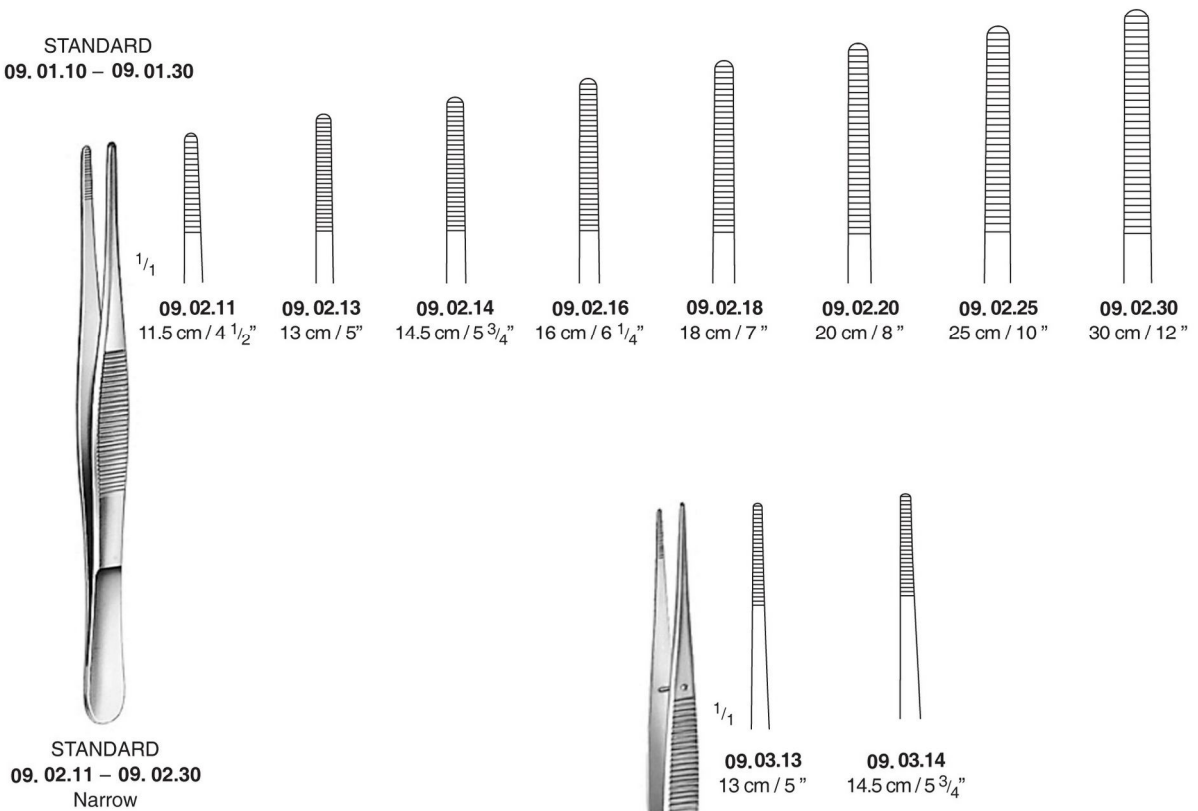
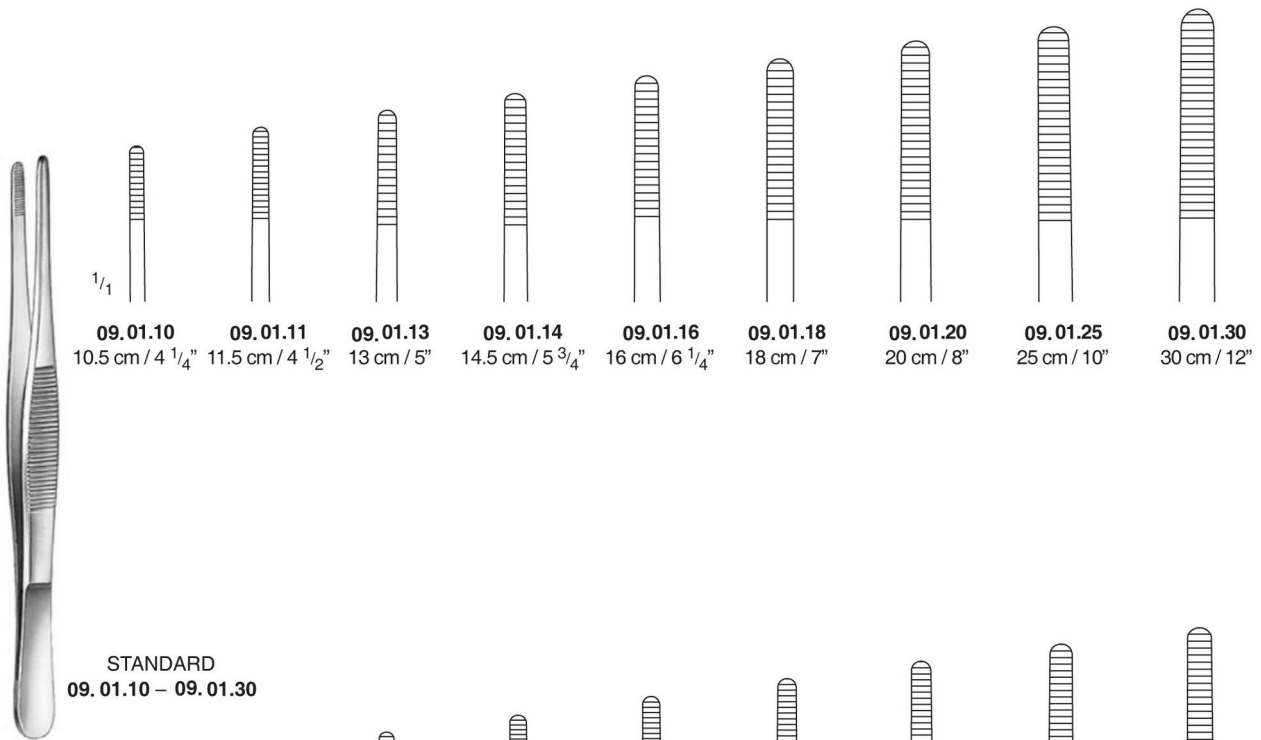
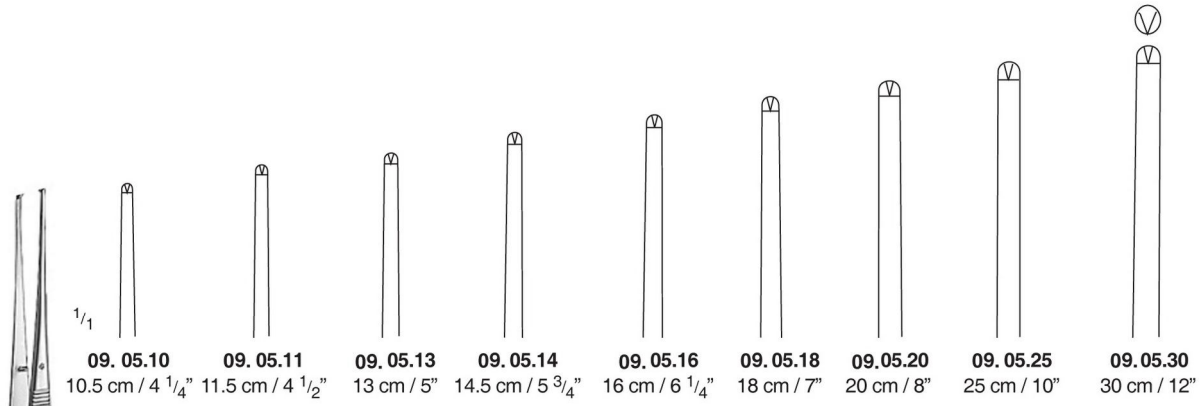
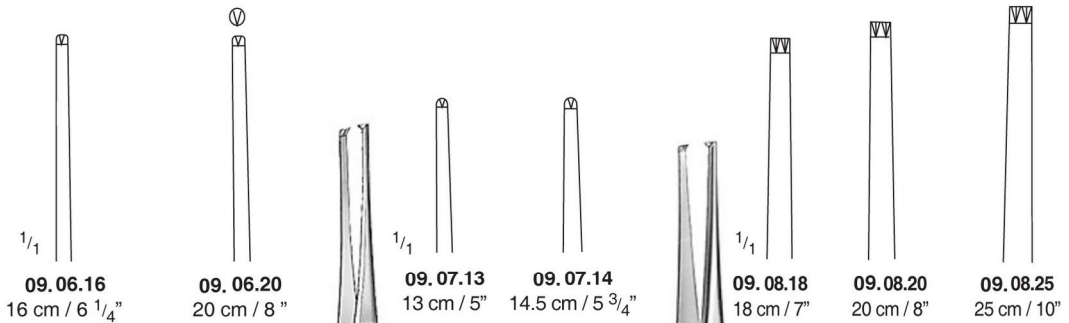
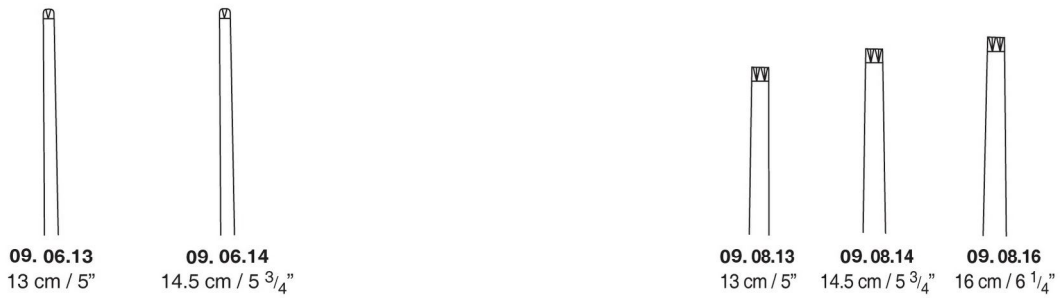

**Dressing and Tissue Forceps**  
**Pincas para Tecidos e roupas**  
**Pinces A Pansement, A Dissection**

Tel# 0092-52-4260785  
Fax# 0092-52-4266804  
Email. [Info@benison.com.pk](mailto:Info@benison.com.pk)

**Dressing Forceps**

**Tissue Forceps**

 09.05.14 – 09.05.30  
 1 x 2 teeth

 MEDIUM  
 09.06.13 – 09.06.20  
 1 X 2 teeth

 DELICATE  
 09.07.13 – 09.07.14  
 1 X 2 teeth

 09.08.13 – 09.08.25  
 2 x 3 teeth

**Tissue Forceps**



$\frac{1}{1}$   
**09. 09.14**  
 14.5 cm / 5  $\frac{3}{4}$ "

$\frac{1}{1}$   
**09. 09.16**  
 16 cm / 6  $\frac{1}{4}$ "

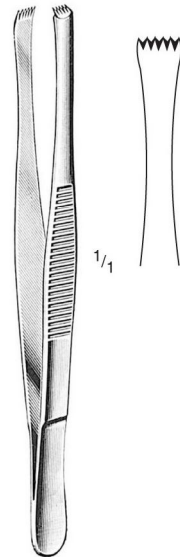

$\frac{1}{1}$   
**09. 10.13**  
 13 cm / 5"

$\frac{1}{1}$   
**09. 10.16**  
 16 cm / 6  $\frac{1}{4}$ "



$\frac{1}{1}$   
**LERCHE**  
**09. 10.15**  
 15 cm / 6"  
 5 X 6 teeth

**09.09.14 – 09. 09.16**  
 3 x 4 teeth

**09. 10.13 – 09. 10.16**  
 4 x 5 teeth

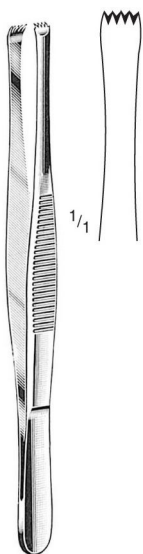

$\frac{1}{1}$   
**STONE**  
**09. 11.15**  
 15 cm / 6"  
 5 x 6 teeth



$\frac{1}{1}$   
**ALDERKRUETZ**  
**09. 11.65 – 09. 12.75**

$\frac{1}{1}$   
**09. 11.65**  
 15 cm / 6"  
 2 x 3 teeth

$\frac{1}{1}$   
**09. 11.70**  
 20 cm / 8"  
 2 x 3 teeth

$\frac{1}{1}$   
**09. 12.65**  
 15 cm / 6"  
 4 x 5 teeth

$\frac{1}{1}$   
**09. 12.70**  
 20 cm / 8"  
 4 x 5 teeth

$\frac{1}{1}$   
**09. 12.75**  
 25 cm / 10"  
 4 x 5 teeth

**Adson Forcep, with Tungsten Carbide T/C Inserts**

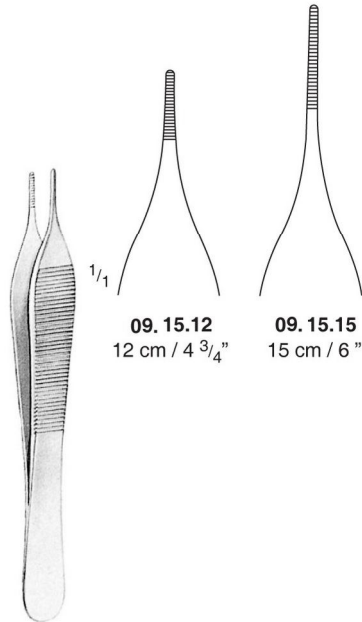

**09.15.12**  
12 cm / 4 <sup>3</sup>/<sub>4</sub> "

**09.15.15**  
15 cm / 6 "

ADSON  
09.15.12 – 09.15.15

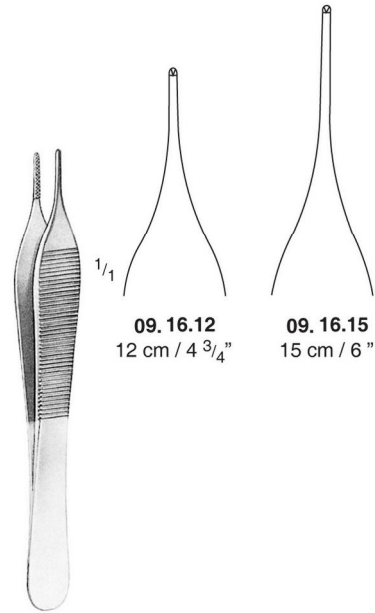

**09.16.12**  
12 cm / 4 <sup>3</sup>/<sub>4</sub> "

**09.16.15**  
15 cm / 6 "

ADSON  
09.16.12 – 09.16.15  
1 x 2 teeth

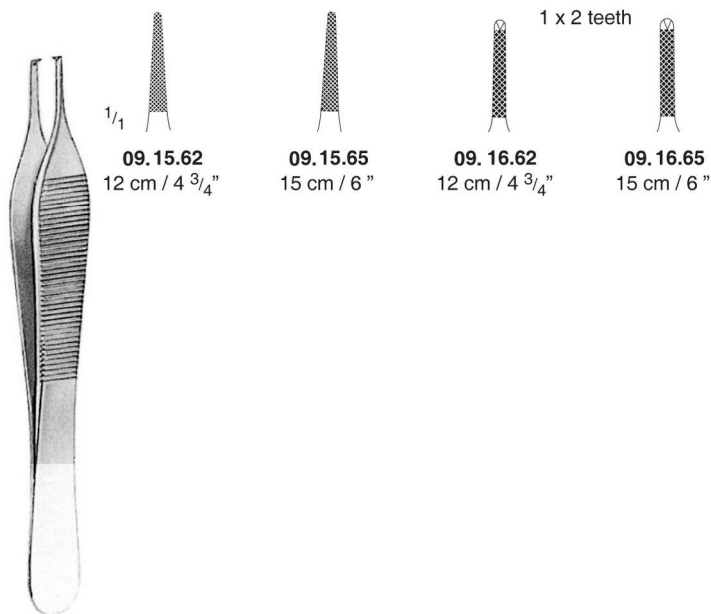

**09.15.62**  
12 cm / 4 <sup>3</sup>/<sub>4</sub> "

**09.15.65**  
15 cm / 6 "

**09.16.62**  
12 cm / 4 <sup>3</sup>/<sub>4</sub> "

**09.16.65**  
15 cm / 6 "

1 x 2 teeth

ADSON T/C  
09.15.62 – 09.16.65

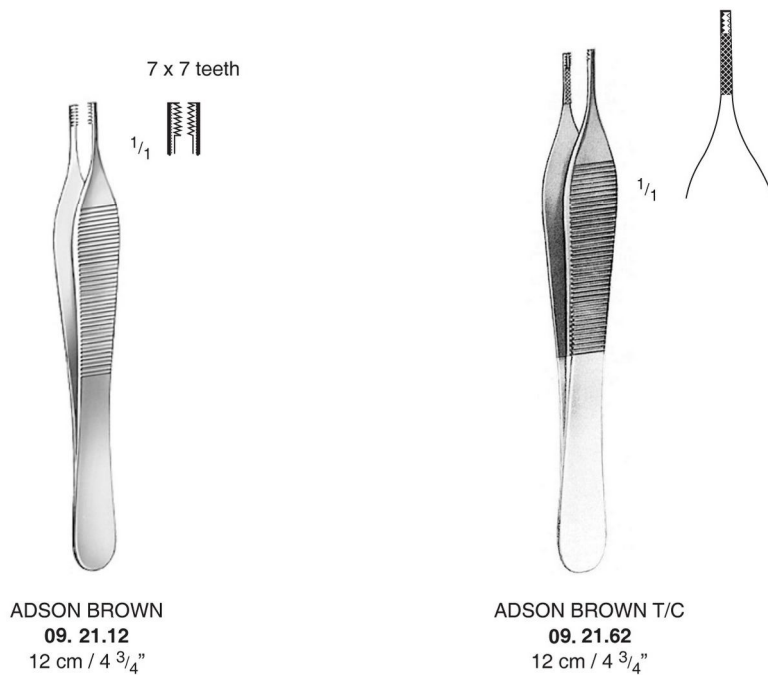
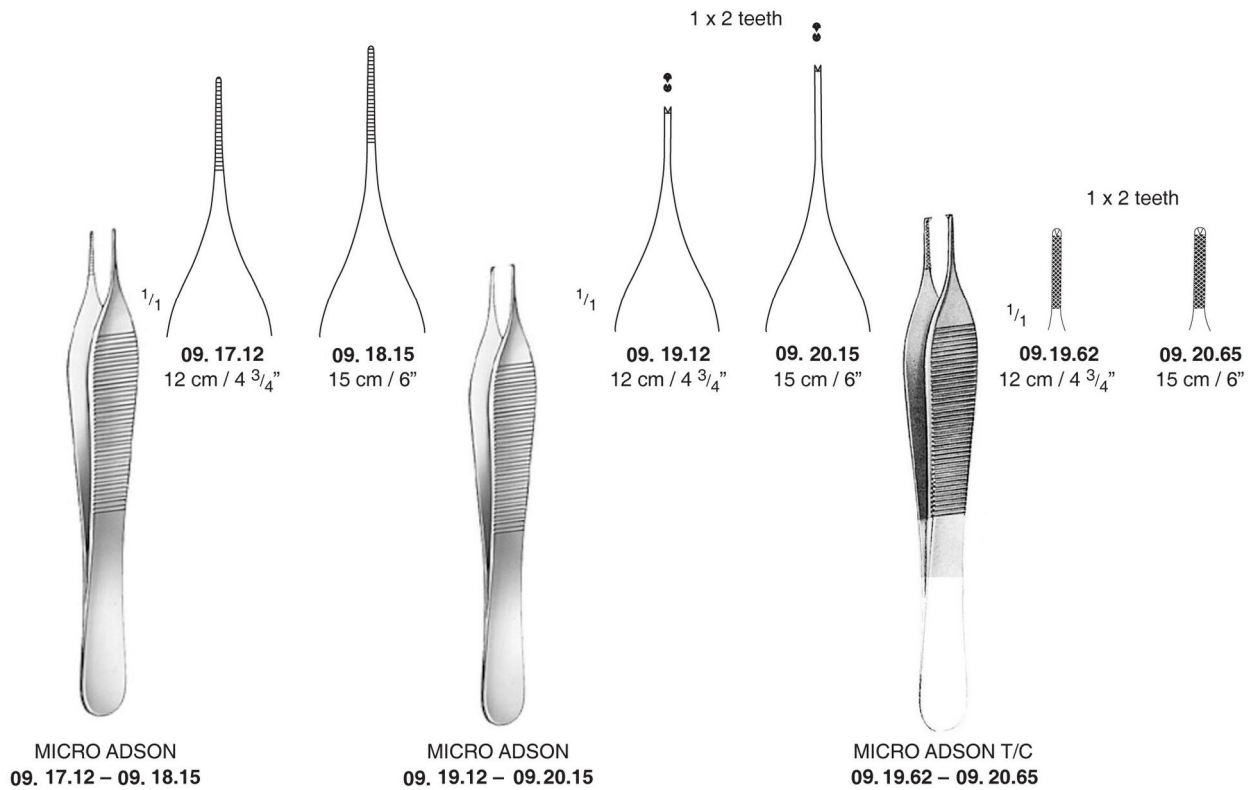
**Micro Tissue Forceps, with Tungsten Carbide T/c Inserts**

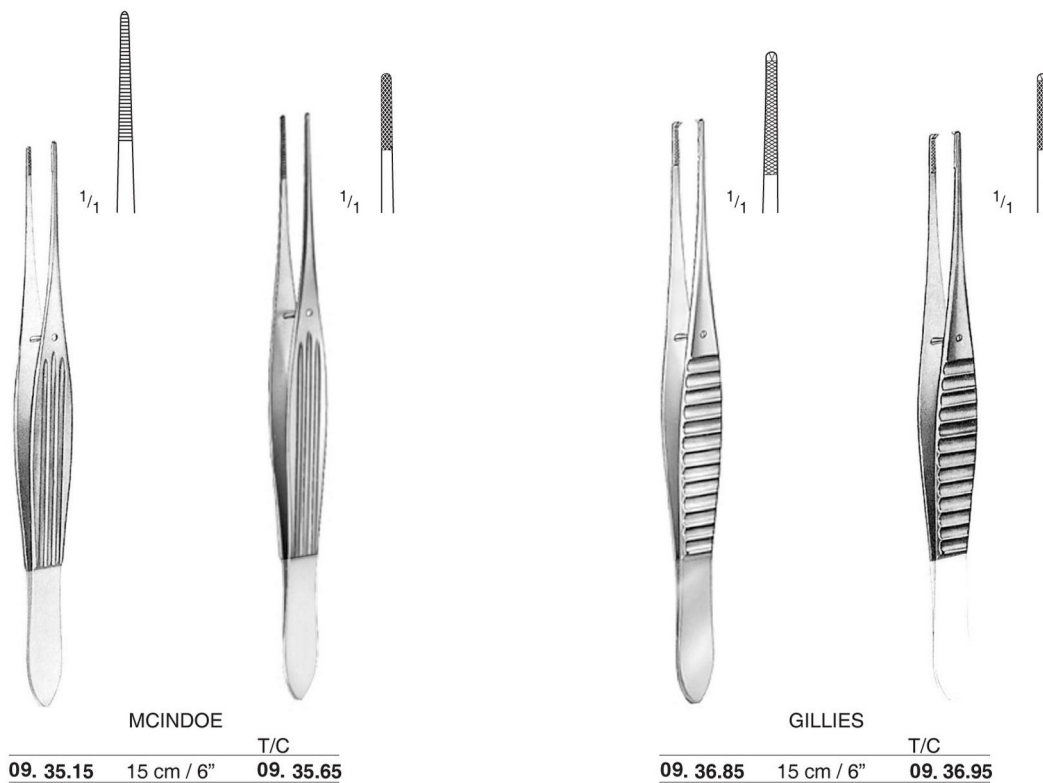
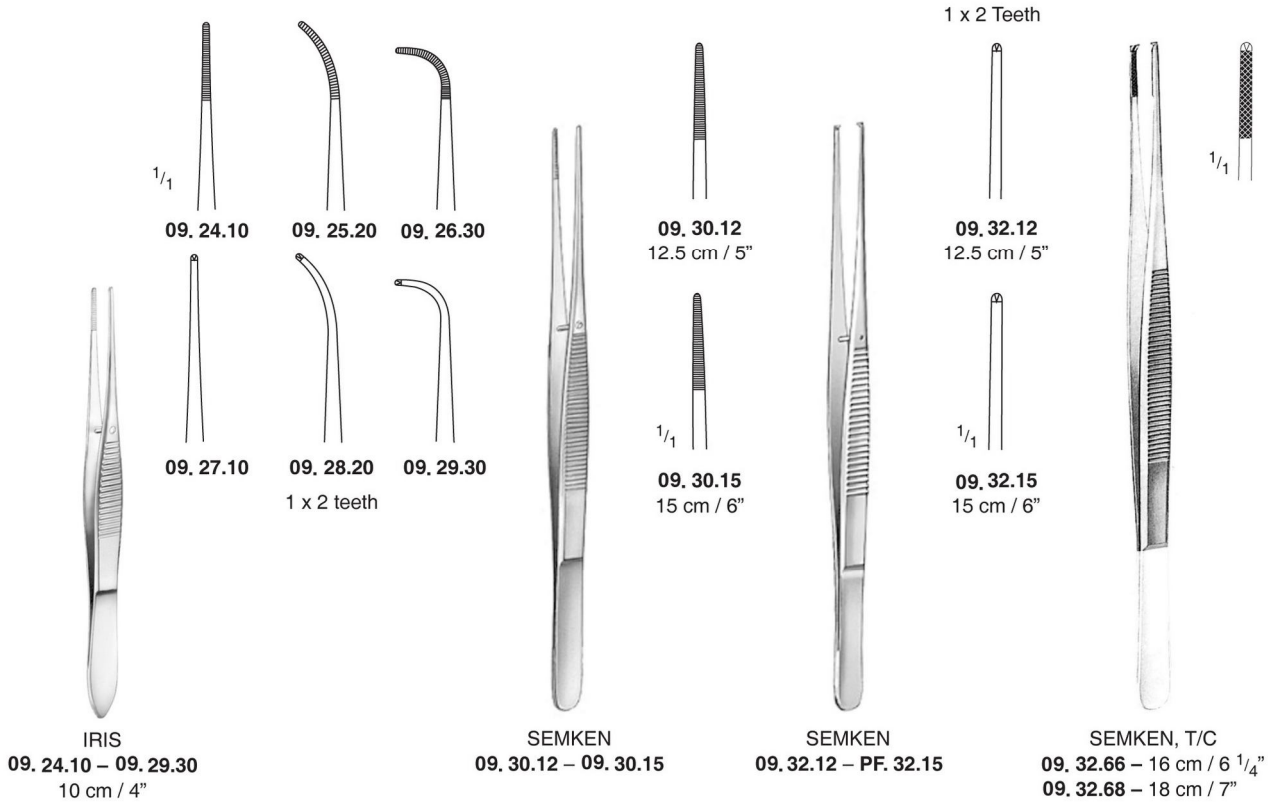
**Delicate Tissue Forceps, with Tungsten Carbide Inserts**

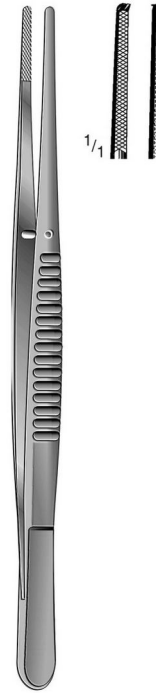
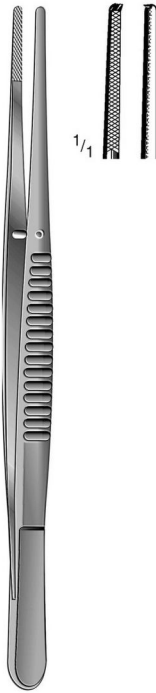
**Tissue Forceps, with Tungsten Carbide Inserts**

		WAUGH	T/C
15 cm / 6"	<b>09.37.15</b>	<b>09.38.15</b>	<b>09.38.65</b>
20 cm / 8"	<b>09.37.20</b>	<b>09.38.20</b>	<b>09.38.70</b>

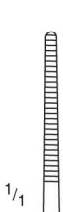
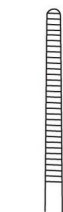
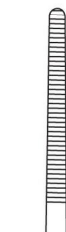
**09.39.18**  
 18 cm / 7"

**09.39.20**  
 20 cm / 8"

**09.39.25**  
 25 cm / 10"

**09.41.18**  
 18 cm / 7"

**09.41.20**  
 20 cm / 8"

**09.41.25**  
 25 cm / 10"

**09.39.68**  
 18 cm / 7"

**PF.39.70**  
 20 cm / 8"

**09.39.75**  
 25 cm / 10"

 POTT SMITH  
 09.39.18 – 09.39.25

 POTT SMITH  
 09.41.18 – 09.41.25  
 1 x 2 teeth

 POTT SMITH, T/C  
 09.39.68 – 09.39.75



**Atraumatic Vascular Forceps**

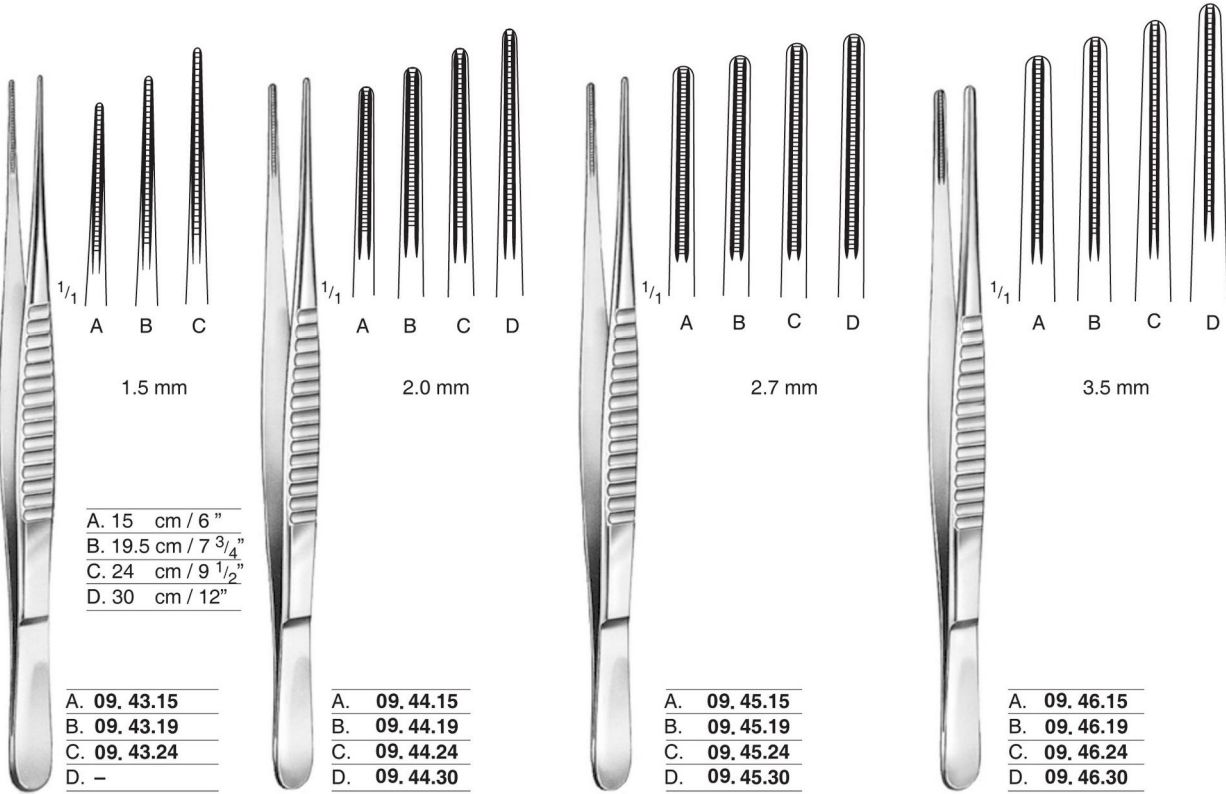

DE BACKEY

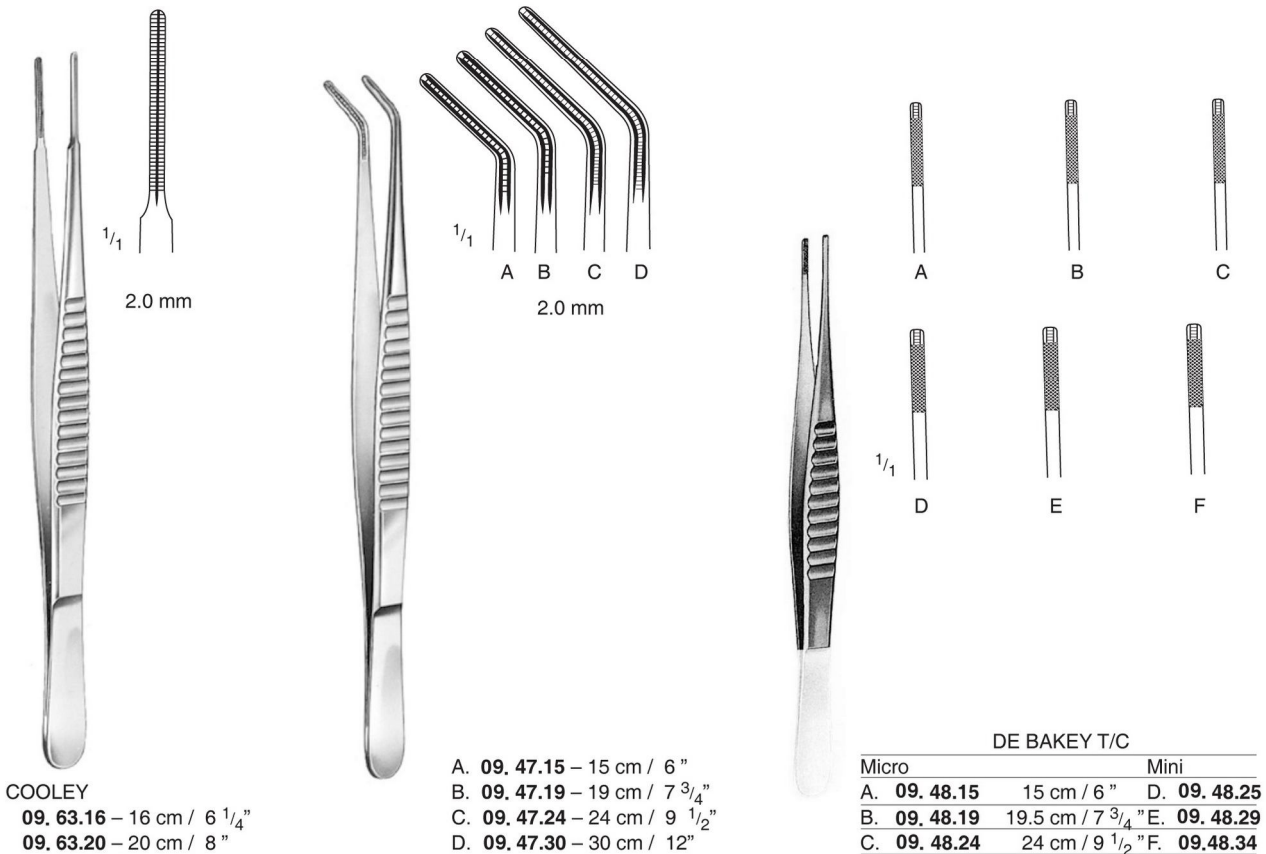

**Atraumatic Vascular Forceps**

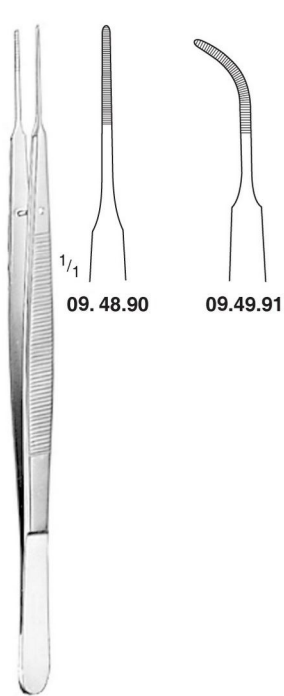

GEARLD  
09. 48.90 – 09. 49.91  
18 cm / 7"

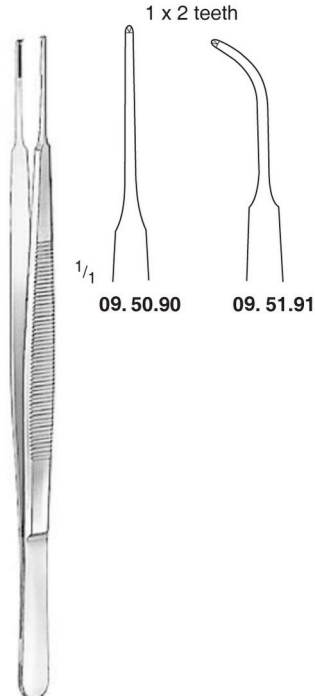

GEARLD  
09. 50.90 – 09. 51.91  
18 cm / 7"



GEARLD, T/C  
09. 48.95 – 09.50.95  
18 cm / 7"

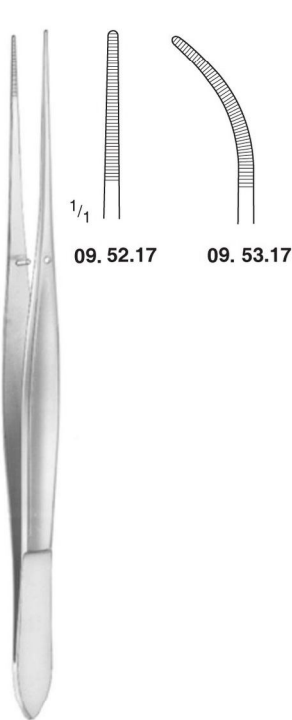

CUSHING  
09. 52.17 – 09. 52.27  
17.5 cm / 7"



CUSHING  
09. 52.37  
17.5 cm / 7"

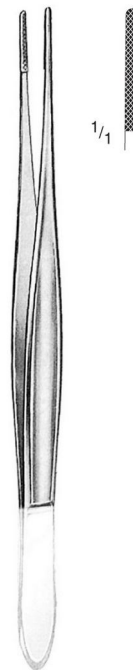

CUSHING T/C  
09. 52.67  
17.5 cm / 7"

**Tissue Grasping Forcep, with Tungsten Carbide T/C Inserts**

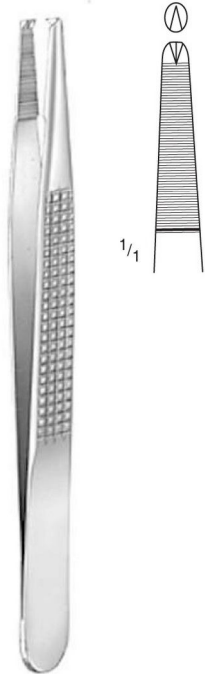

**BONNEY**  
**09. 52.91**  
18 cm / 7"

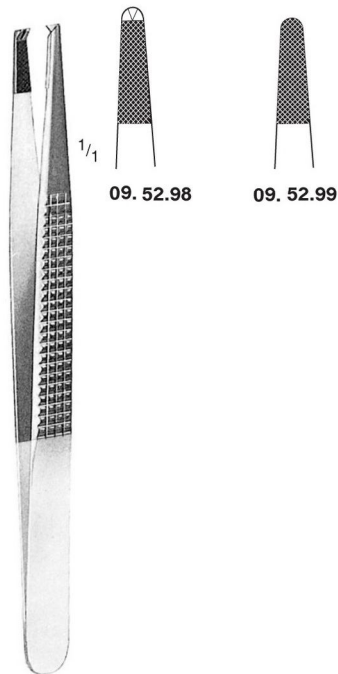

**BONNEY T/C**  
**09. 52.98 – 09. 52.99**  
18 cm / 7"



**TAYLOR**  
**09. 53.17**  
17.5 cm / 7"



**TAYLOR**  
**09. 53.27**  
17.5 cm / 7"



**TAYLOR**  
**09. 54.17**  
17.5 cm / 7"



**TAYLOR**  
**09. 54.27**  
17.5 cm / 7"



**TAYLOR**  
**09. 55.17**  
17.5 cm / 7"



**TAYLOR**  
**09. 55.27**  
17.5 cm / 7"



**TAYLOR, T/C**  
**09. 55.67**  
17.5 cm / 7"

**Tissue Grasping Forceps**

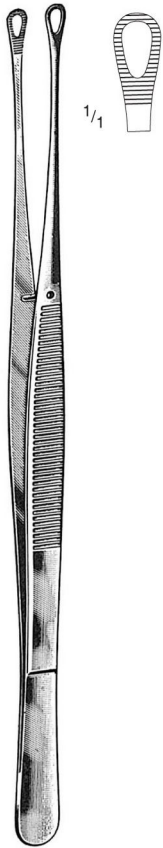

TUTTLE (SINGLEY)  
09.58.18 – 18 cm / 7"  
09.58.23 – 23 cm / 9"



09.59.15  
15 cm / 6"

09.59.20  
20 cm / 8"

09.59.25  
25 cm / 10"

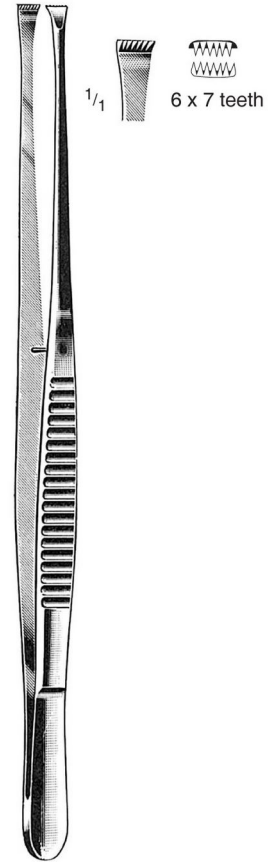

NELSON  
09.60.15 – 15 cm / 6"  
09.60.23 – 23 cm / 9"

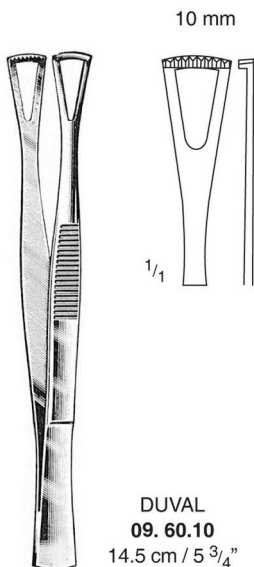

DUVAL  
09.60.10  
14.5 cm / 5 3/4"

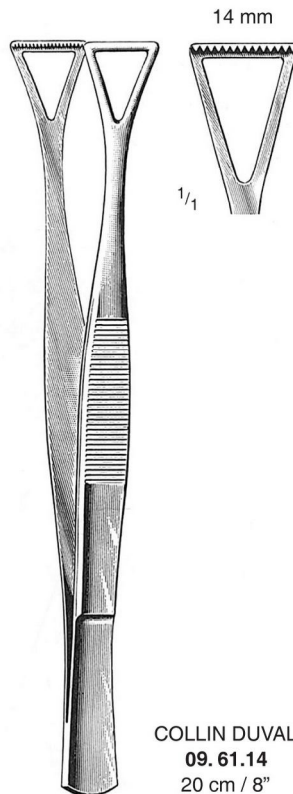

COLLIN DUVAL  
09.61.14  
20 cm / 8"

**Ear and Nasal Dressing Forceps**

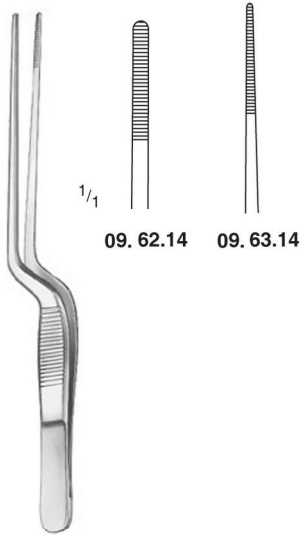

LUCAE  
09. 62.14 – 09. 63.14  
14 cm / 5 1/2"

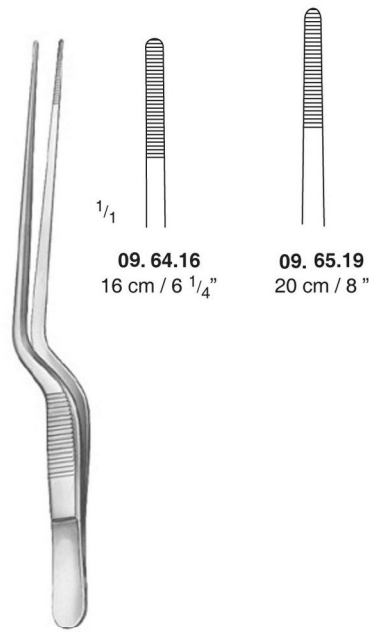

GRUENWALD (JANSEN)  
09. 64.16 – 09. 65.19

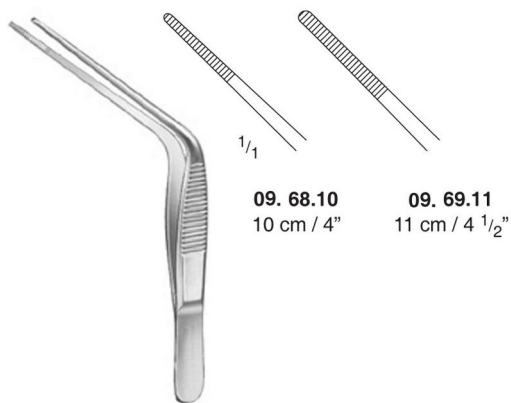

TROELTSCH (WILDE)  
09. 68.10 – 09. 69.11

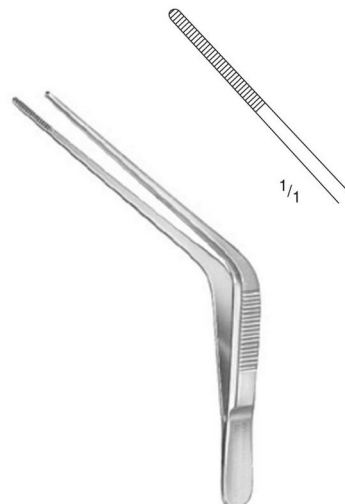

TROELTSCH (WILDE)  
09. 70.13  
13 cm / 5"

**Delicate Pattern Forceps, Splinter Forcep**

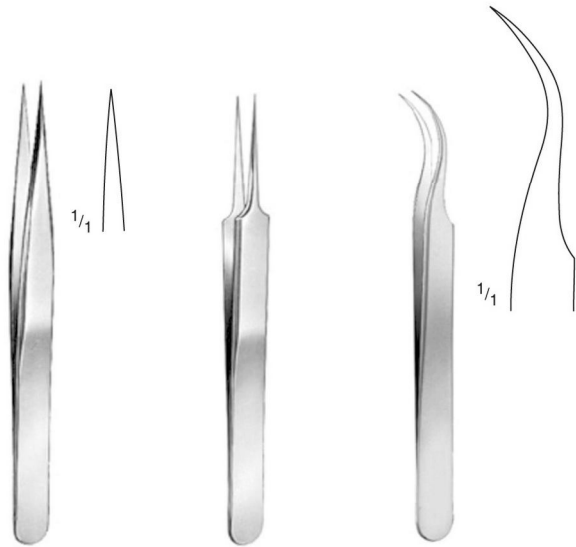

JEWELLER STYLE

<b>09.79.03</b>	<b>09.81.05</b>	<b>09.82.07</b>
No. 3	No. 5	No. 7
11.5 cm / 4 1/2"	11 cm / 4 1/4"	11.5 cm / 4 1/2"

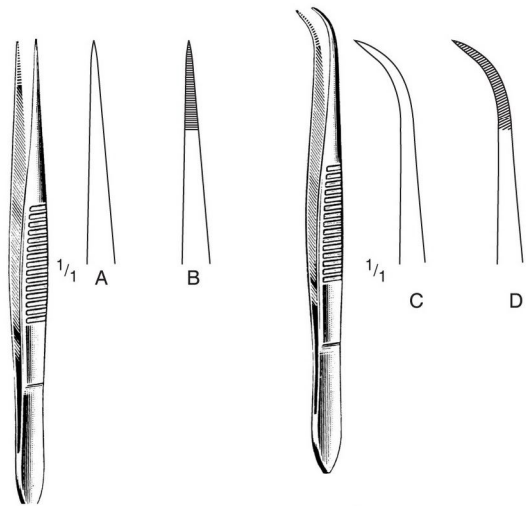

<b>A</b>	<b>B</b>		<b>C</b>	<b>D</b>
<b>09.90.09</b>	<b>09.90.19</b>	9 cm / 3 1/2"	<b>09.91.09</b>	<b>09.91.19</b>
<b>09.90.11</b>	<b>09.90.21</b>	11 cm / 4 1/2"	<b>09.91.11</b>	<b>09.91.21</b>
<b>09.90.12</b>	<b>09.90.22</b>	12.5 cm / 5"	<b>09.91.12</b>	<b>09.91.22</b>

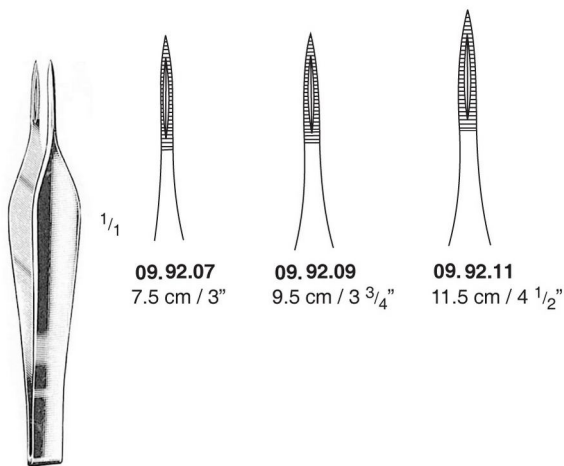

**09.92.07**  
7.5 cm / 3"

**09.92.09**  
9.5 cm / 3 3/4"

**09.92.11**  
11.5 cm / 4 1/2"

FEILCHENFELD  
09.92.07 – 09.92.11

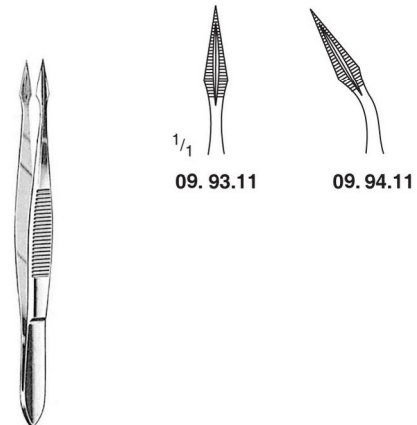

**09.93.11**

**09.94.11**

HUNTER  
09.93.11 – 09.94.11  
11 cm / 4 1/2"

**Cilia Forcep, Splinter Forceps**

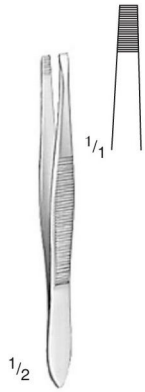

**DOUGLAS**  
**09. 98.09**  
9 cm / 3 1/2"

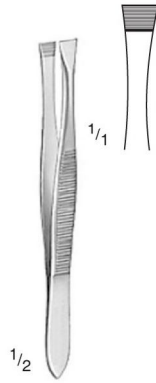

**DOUGLAS**  
**09. 99.09**  
9 cm / 3 1/2"

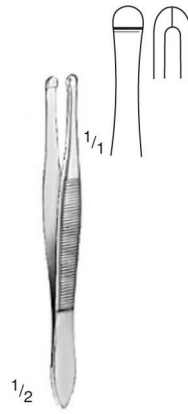

**BEER**  
**09.102.09**  
9 cm / 3 1/2"



**BARRAQUER**  
**09. 105.10**  
10.5 cm / 4 1/4"



**STEIGLITZ**  
**09. 88.24 - 09. 88.34**  
14 cm / 5 1/2"

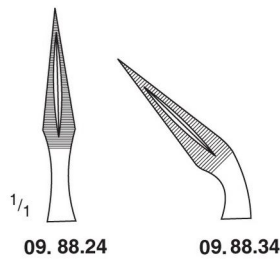

**09. 88.24**

**09. 88.34**



**RALKS**  
**09. 89.14 - 09. 89.24**  
14.5 cm / 5 1/2"

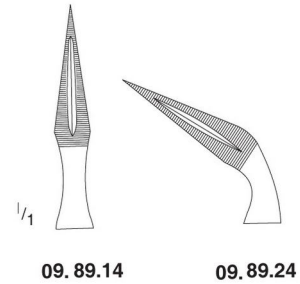

**09. 89.14**

**09. 89.24**

**Micro Eye Forceps, Chalazion Forceps**

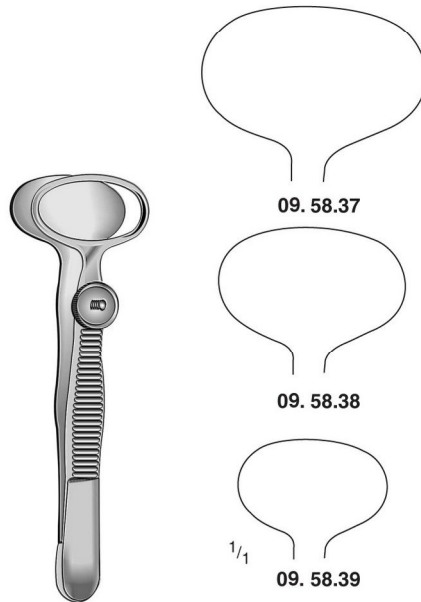
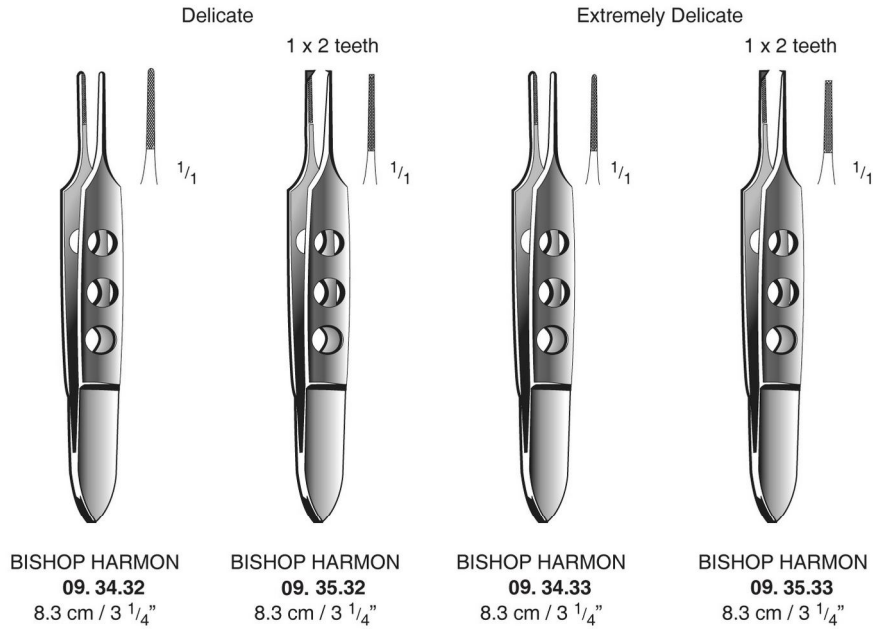

DESMARRES  
**09. 58.37 - 09. 58.39**  
 9.5 cm / 3 3/4"