

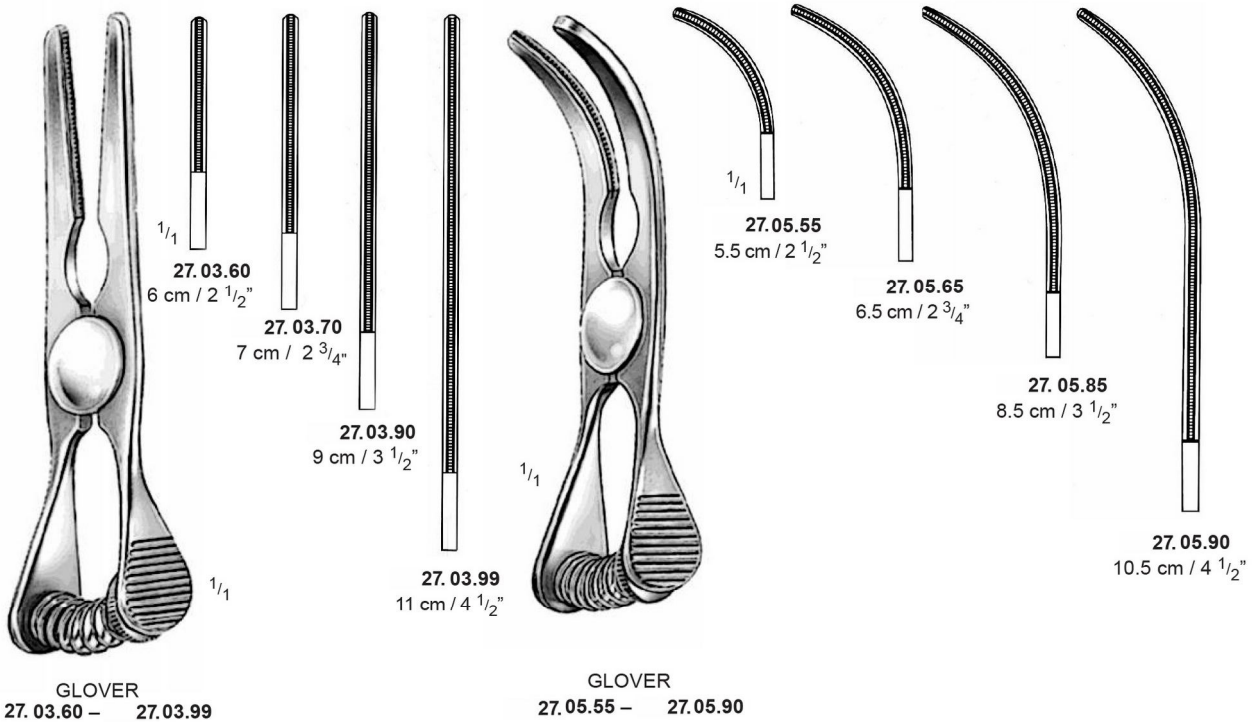

Cardiovascular Instruments
Instrumentais Cardiovasculares
Instruments Cardio-vasculaires

Tel# 0092-52-4260785
Fax# 0092-52-4266804
Email. Info@benison.com.pk

Atraumatic Bulldog Clamps

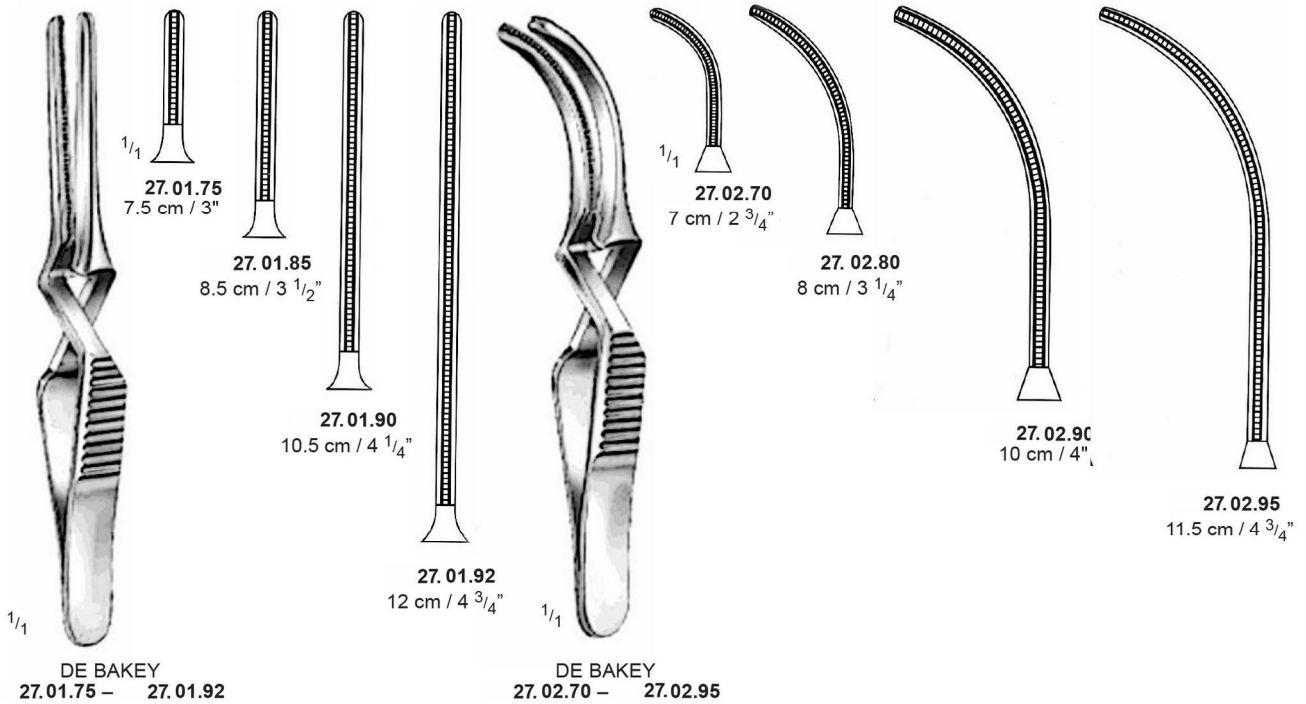

Atraumatic Cardiovascular Forceps

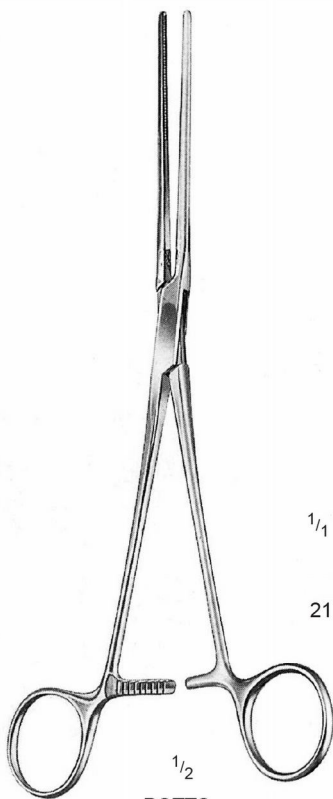

POTTS
27.06.21 - 27.06.22



27.06.21
21 cm / 8 1/4"

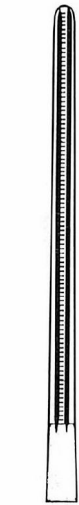

27.06.22
22 cm / 8 3/4"

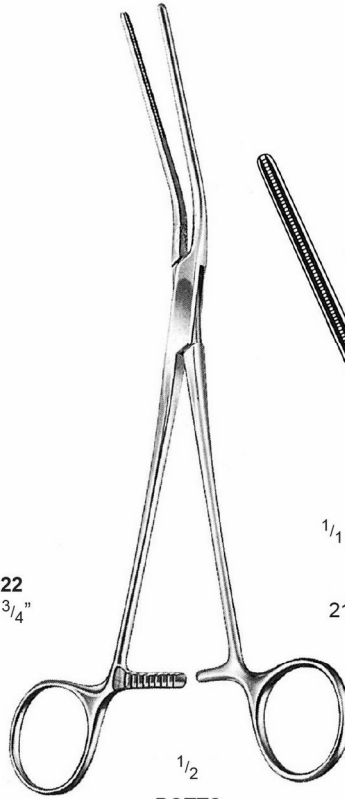

POTTS
27.07.21 - 27.07.22



27.07.21
21 cm / 8 1/4"

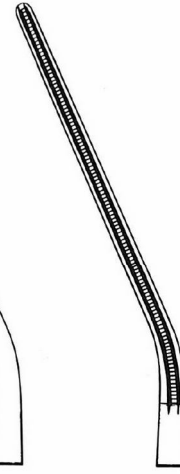

27.07.22
22 cm / 8 3/4"

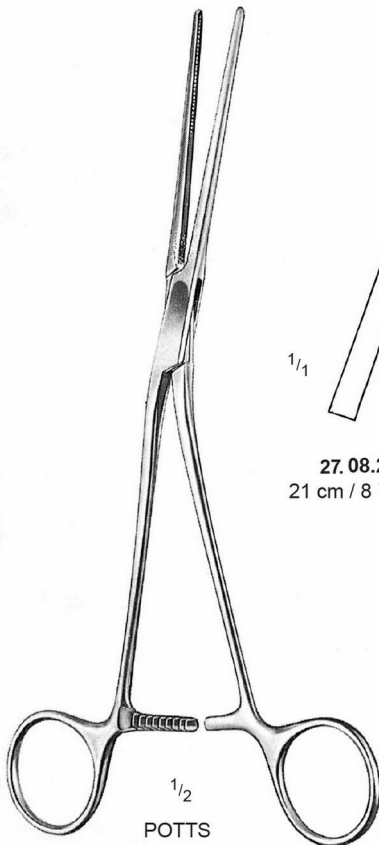

POTTS
27.08.21 - 27.08.22

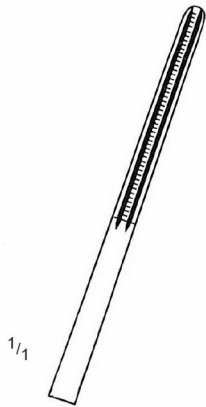

27.08.21
21 cm / 8 1/4"

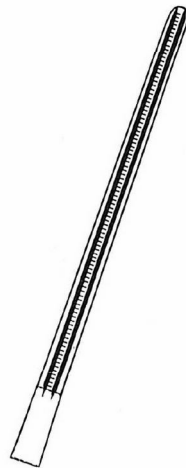

27.08.22
22 cm / 8 3/4"

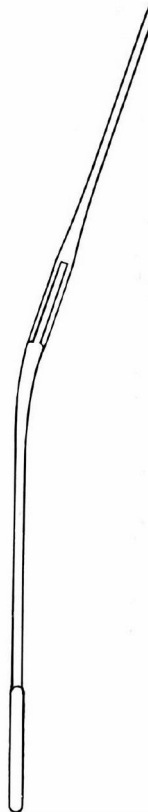

27.06.21 27.08.22 Coarctation Forceps

Atraumatic Cardiovascular Forceps

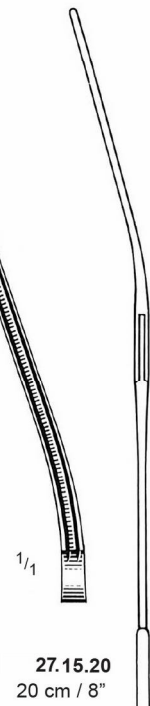
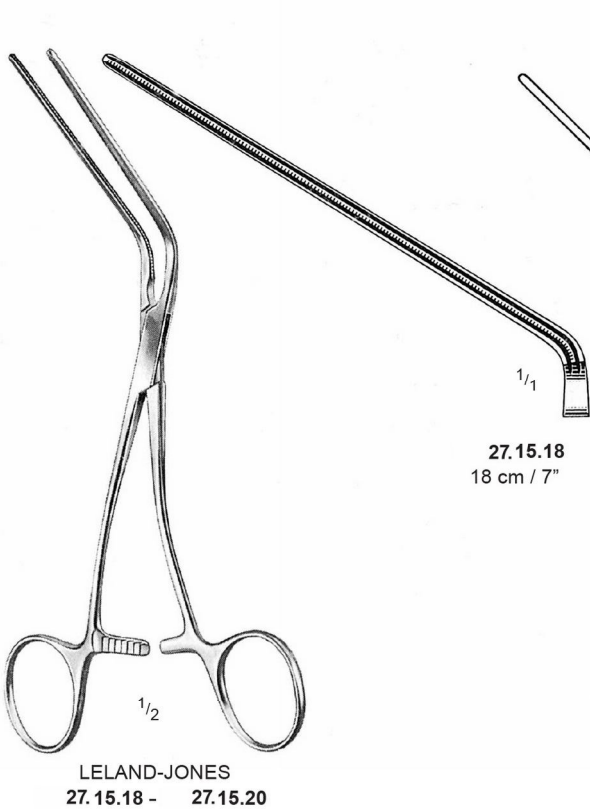
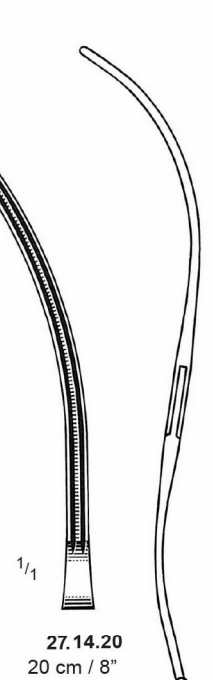
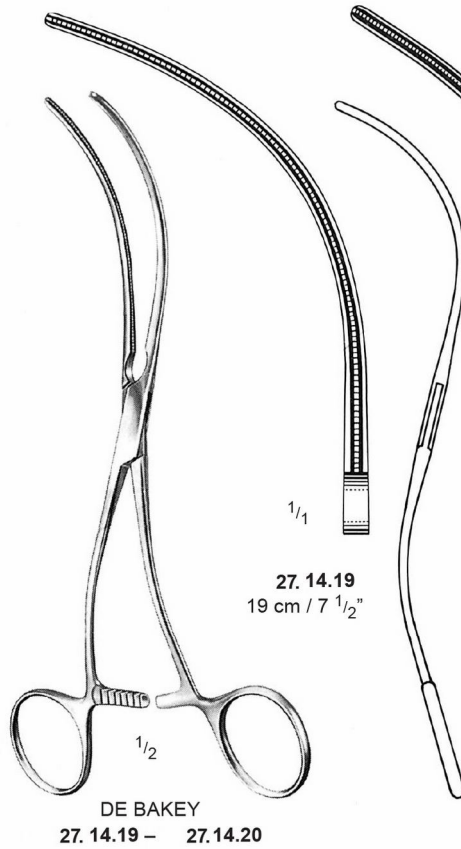
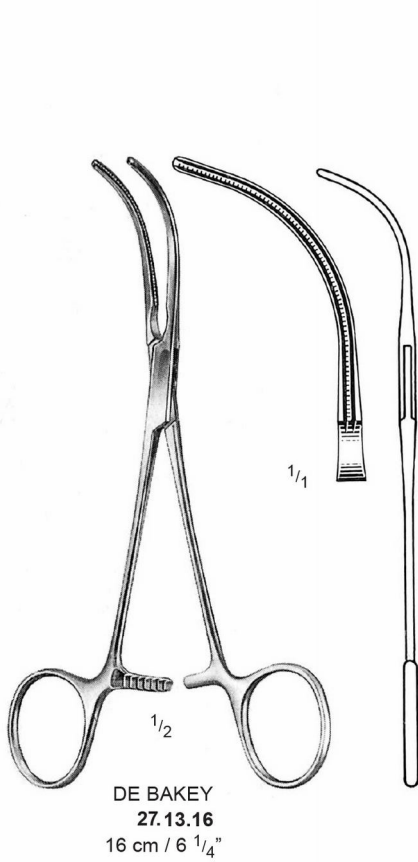

Atraumatic Cardiovascular Forceps

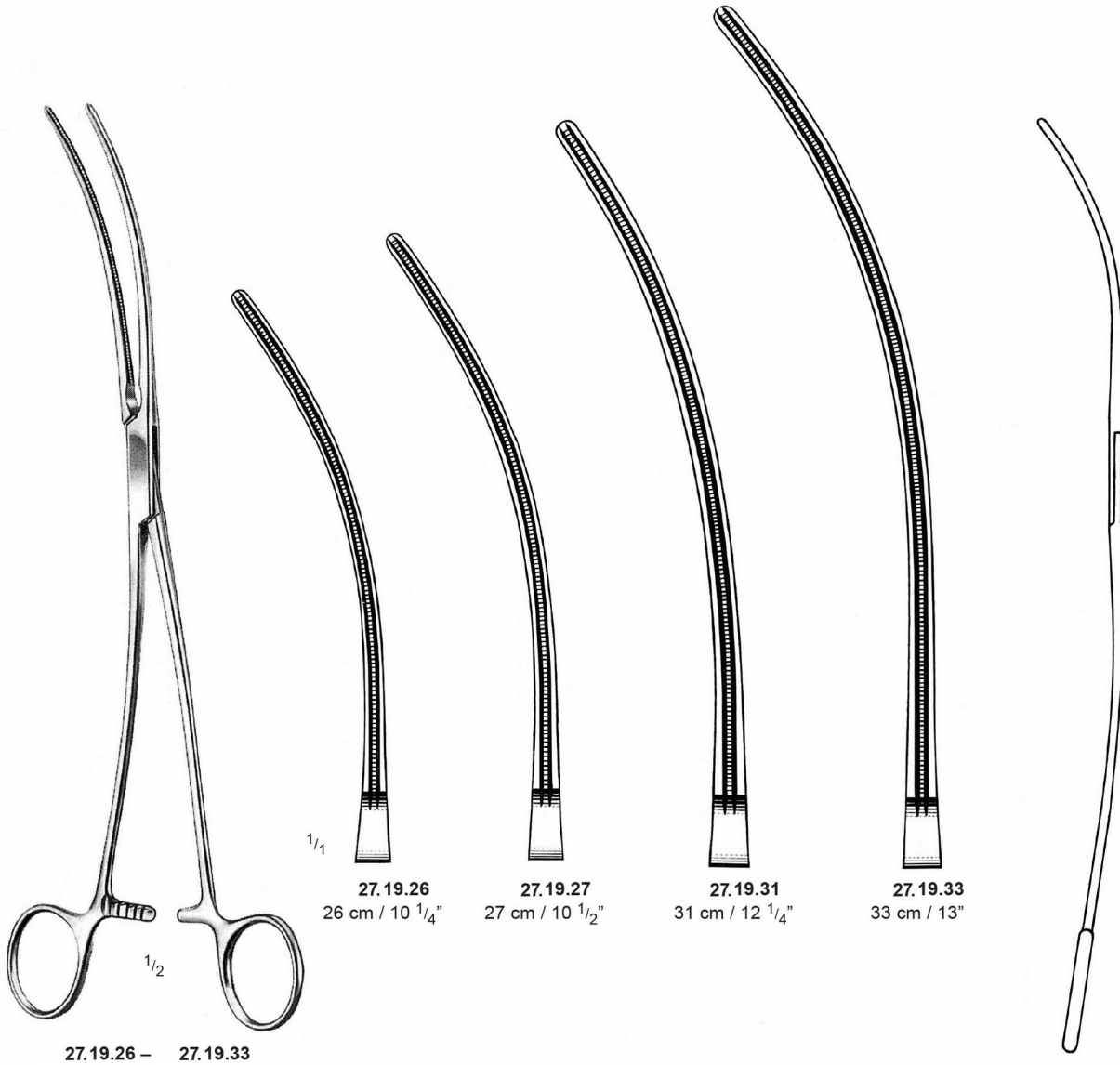

27.19.26 – 27.19.33 Aortic Aneurysm Clamps

Atraumatic Cardiovascular Forceps

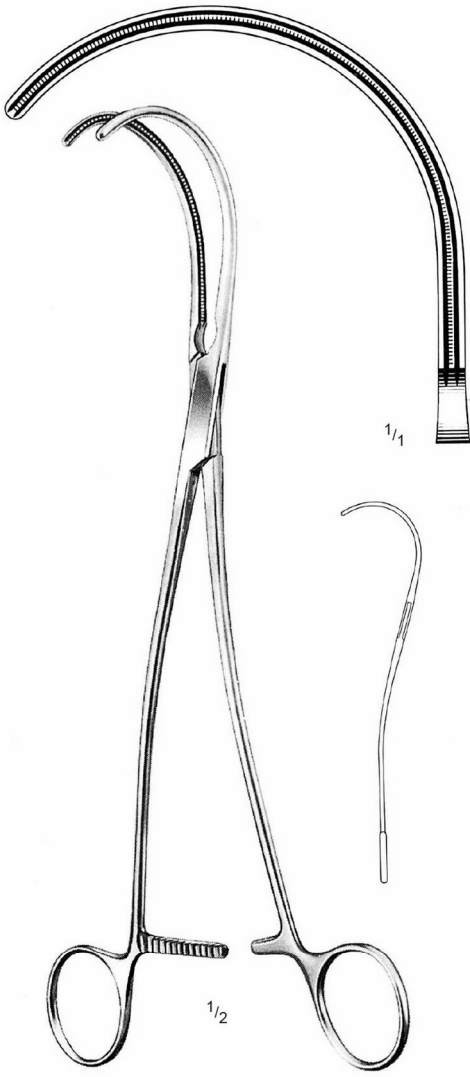

DE BAKEY
27.25.26
26 cm / 10 1/4"

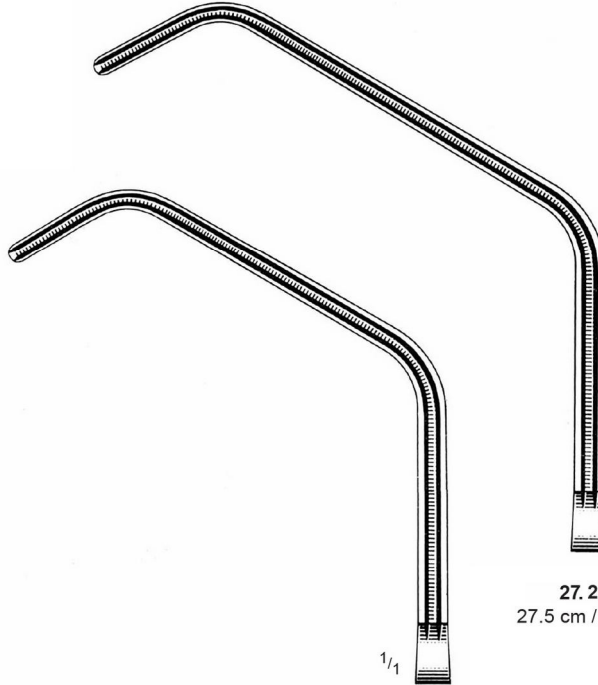

27.28.26
26.5 cm / 10 1/2"

27.28.27
27.5 cm / 10 3/4"



SATINSKY
27.28.20 - 27.28.27

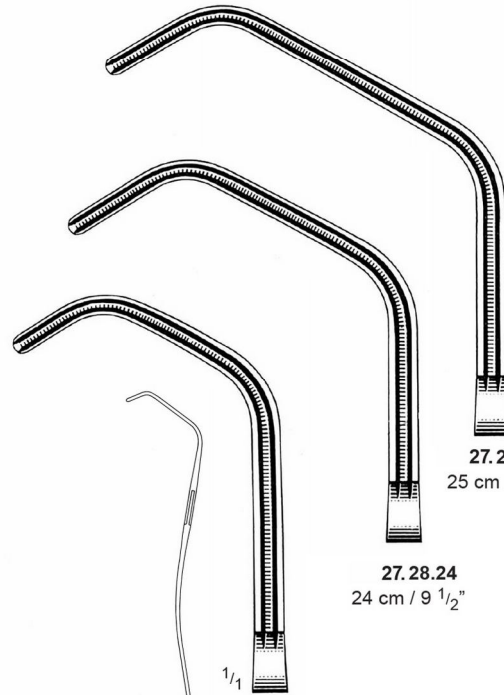

27.28.24
24 cm / 9 1/2"

27.28.25
25 cm / 10"

27.25.26 - Ligature Forceps
27.28.20 - 27.28.27 - Tangential Occlusion Clamps

Atraumatic Cardiovascular Forceps

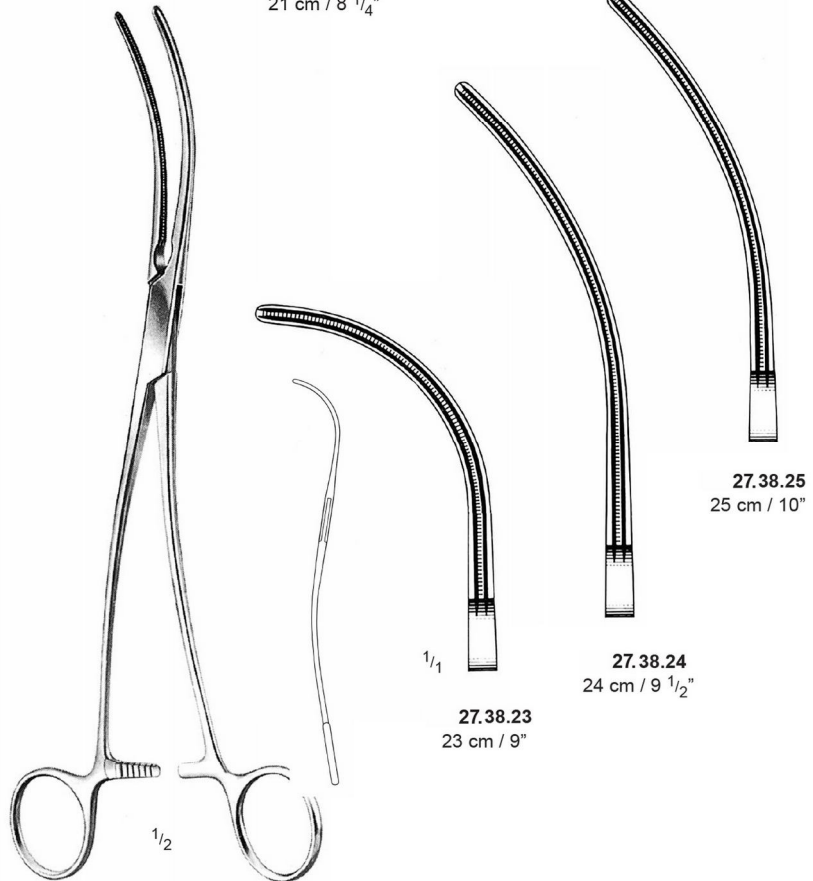
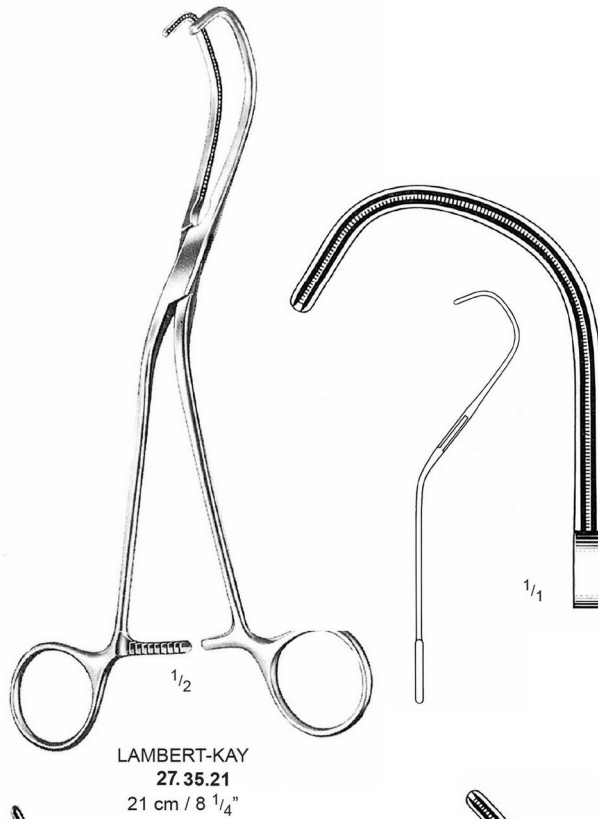
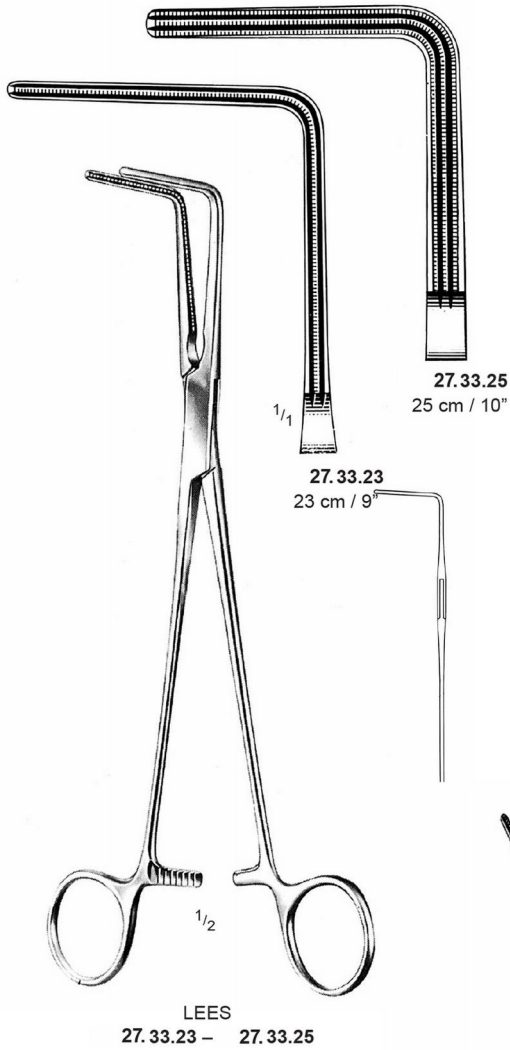

27.33.23 - 27.33.25 - Bronchus Clamps
27.38.23 - 27.38.25 - Aortic Aneurysm / Iliac Artery Clamps

DE BAKEY
27.38.23 - 27.38.25

Atraumatic Cardiovascular Forceps

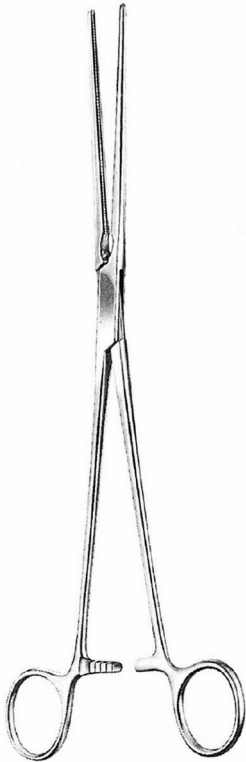

27.39.21 – 27.39.31

1/1



27.39.21
21.5 cm / 8 1/2"



27.39.23
23 cm / 9"



27.39.27
27 cm / 10 1/2"



27.39.31
31.5 cm / 12 1/2"

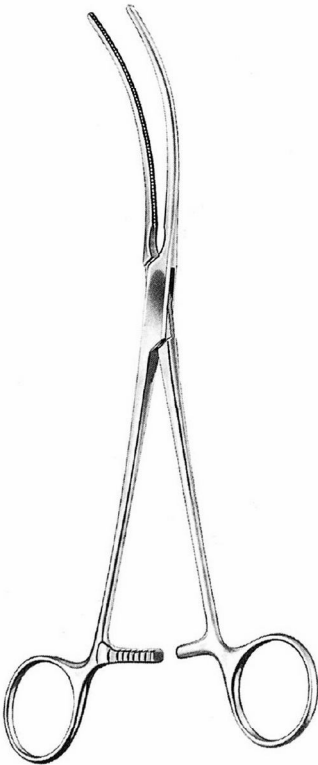

27.40.21 – 27.40.31

1/1

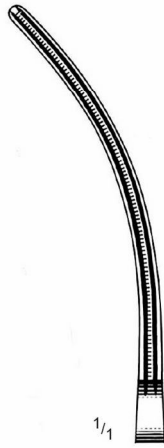

27.40.21
21.5 cm / 8 1/2"

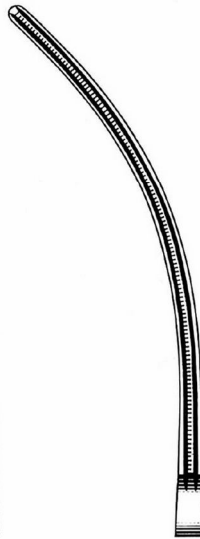

27.40.23
23 cm / 9"

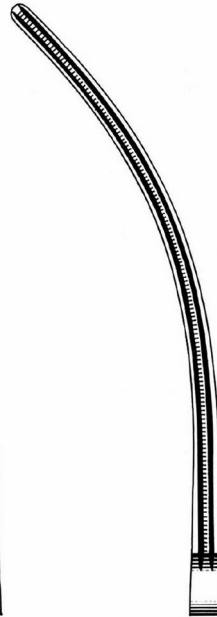

27.40.27
27 cm / 10 1/2"

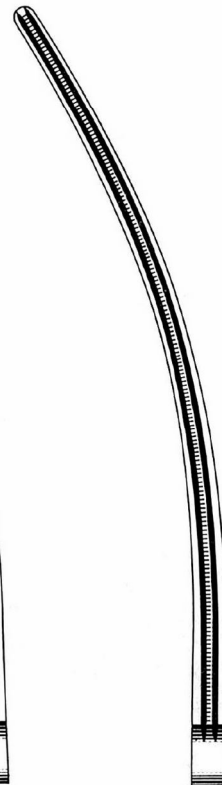

27.40.31
31.5 cm / 12 1/2"

27.40.21 – 27.40.31 Coarctation Clamps

Atraumatic Cardiovasculr Forceps

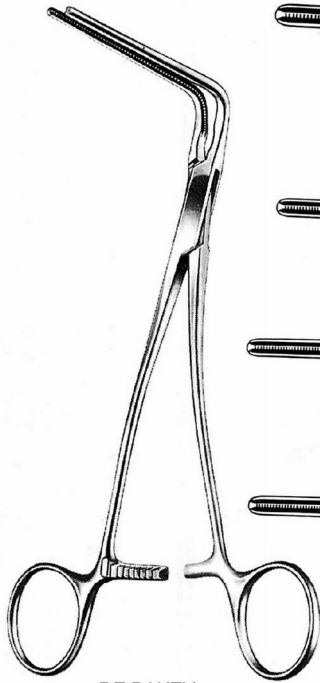

DE BAKEY
27.41.18 - 27.41.27

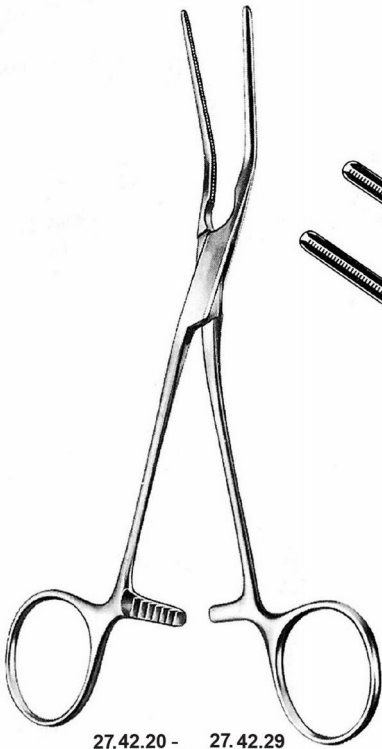
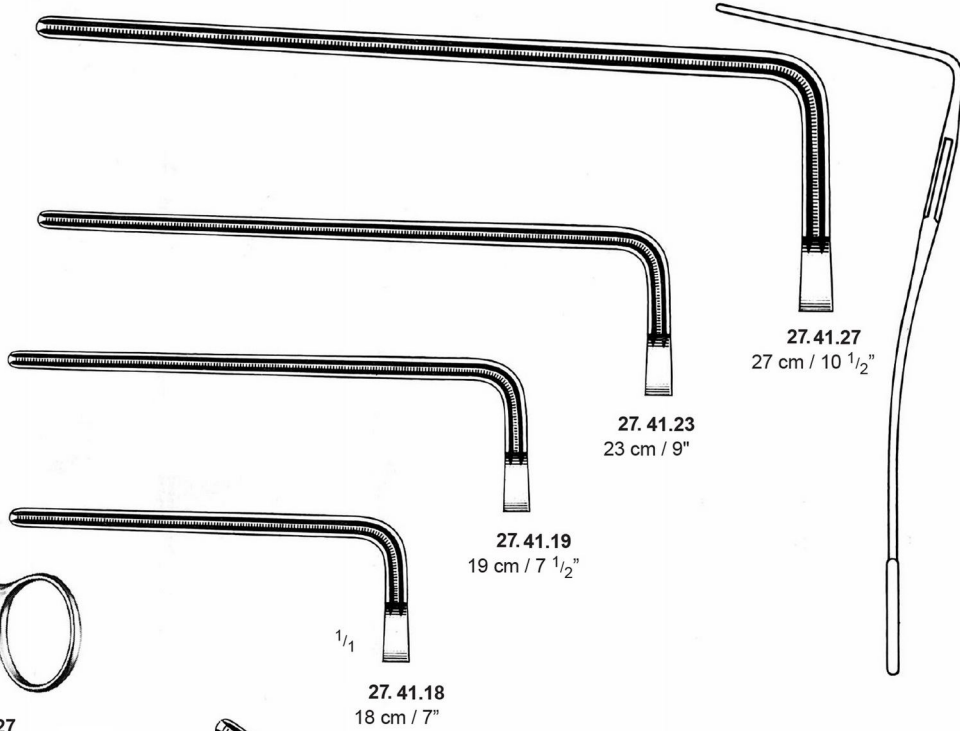

27.42.20 - 27.42.29

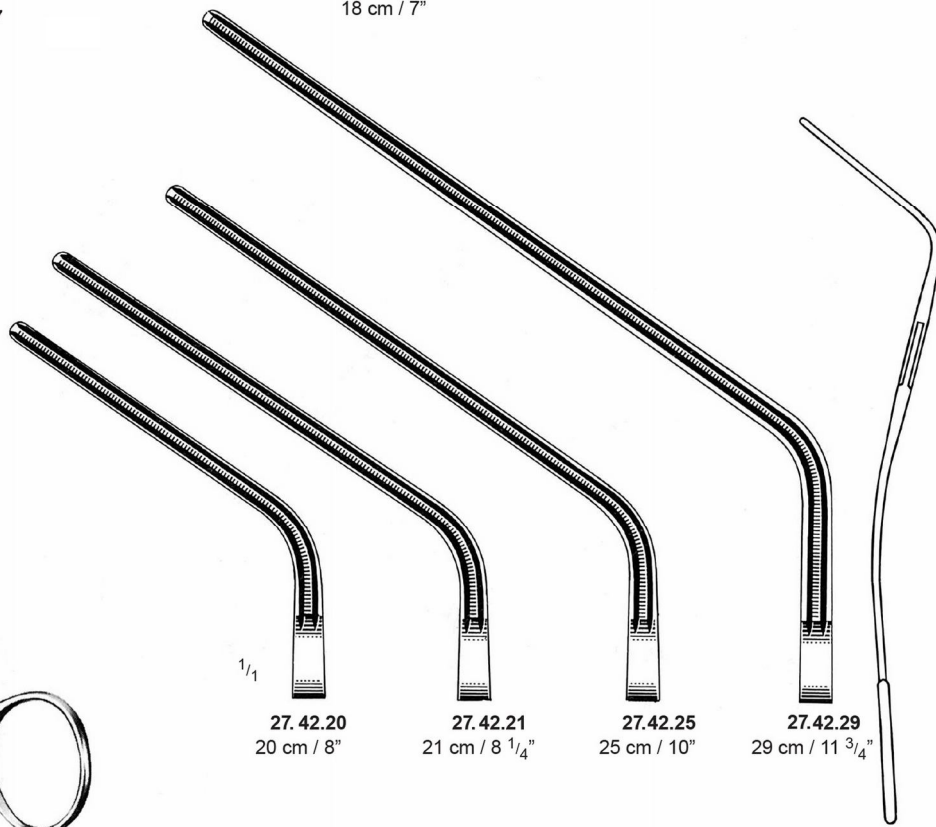

PAA. 42.20 – PAA. 42.29 – Multi Purpose Clamps

Atrauma Cardiovascula Forcep

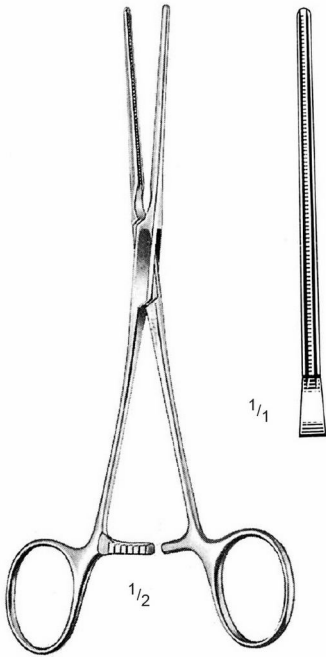

DE BAKY
27.46.17
17 cm / 6 3/4"

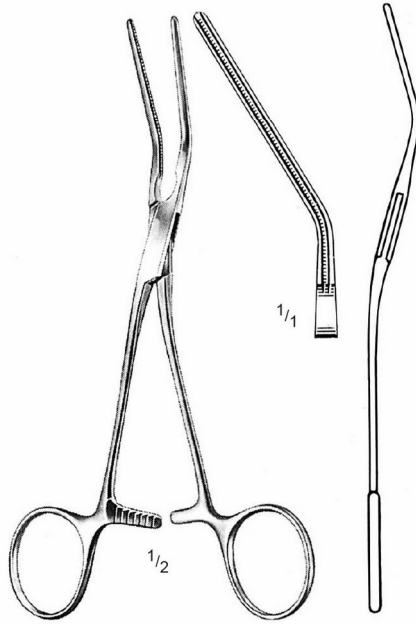

DE BAKY
27.47.16
16 cm / 6 1/4"

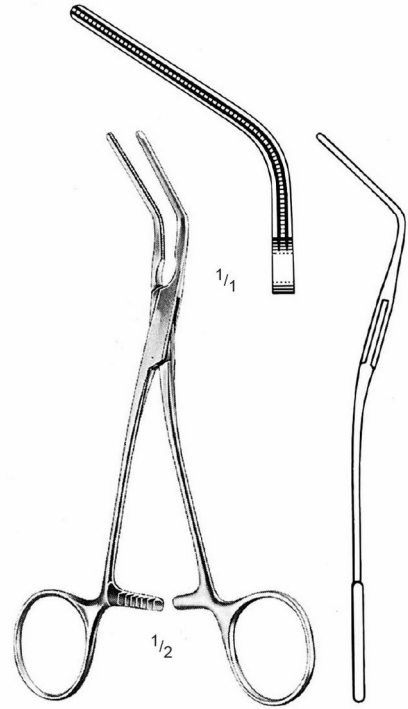

DE BAKY
27.48.15
15 cm / 6"

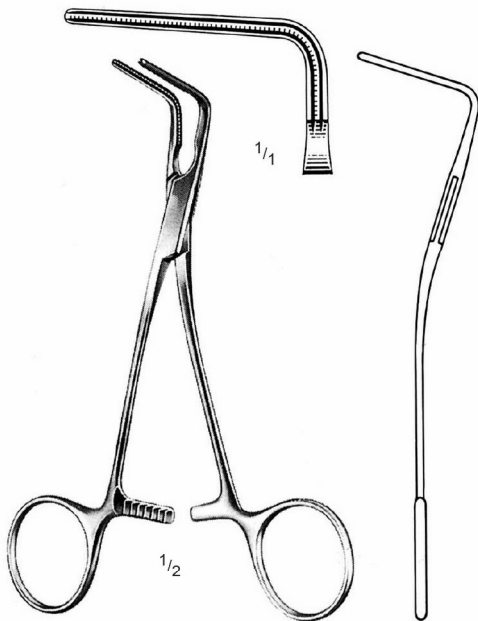

DE BAKY
27.50.15
15 cm / 6"

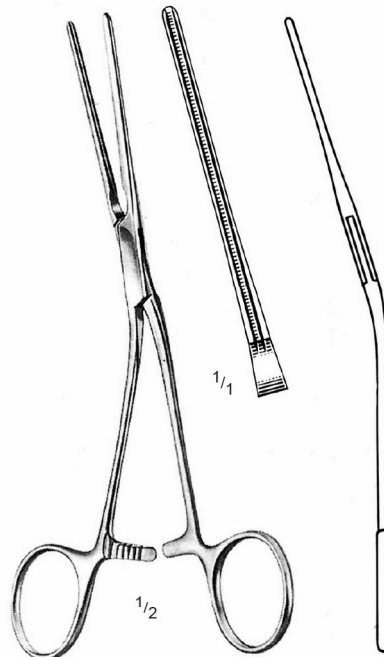

DE BAKY
27.51.17
17 cm / 6 3/4"

Atraumatic Cardiovascular Forceps

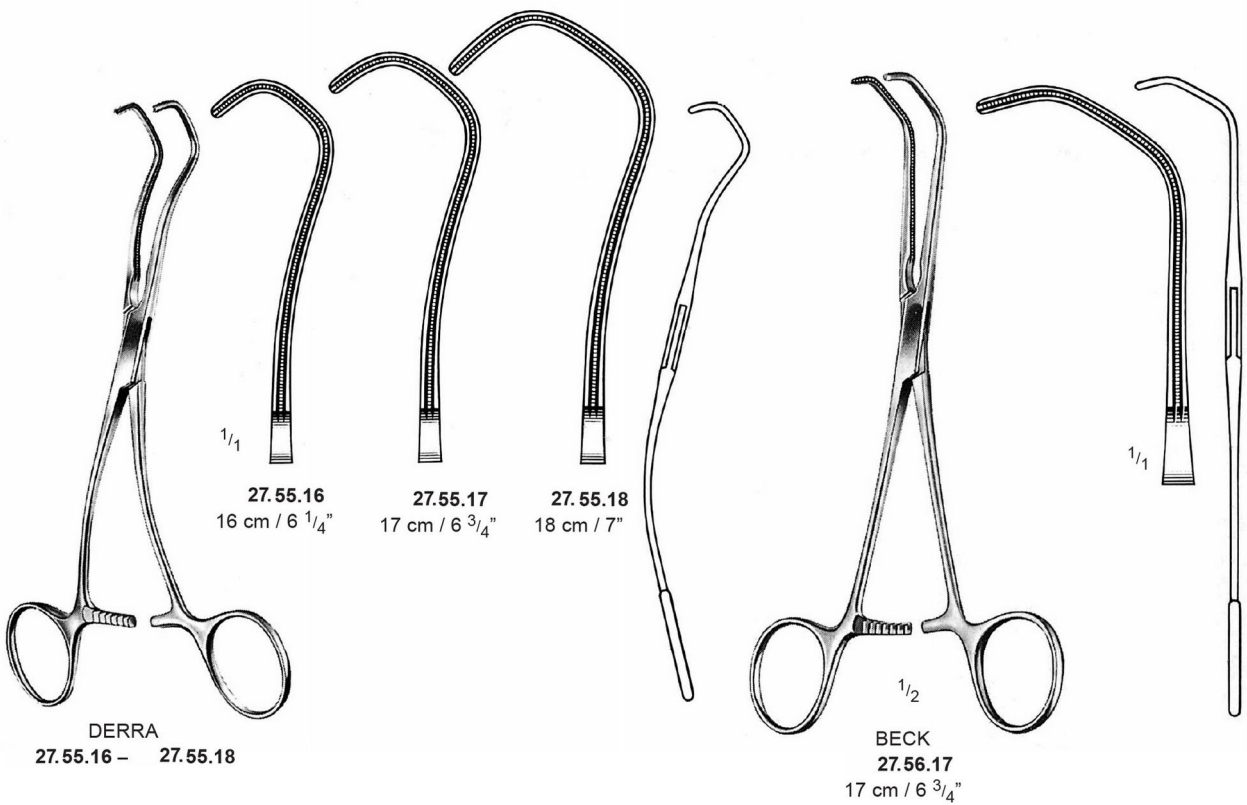
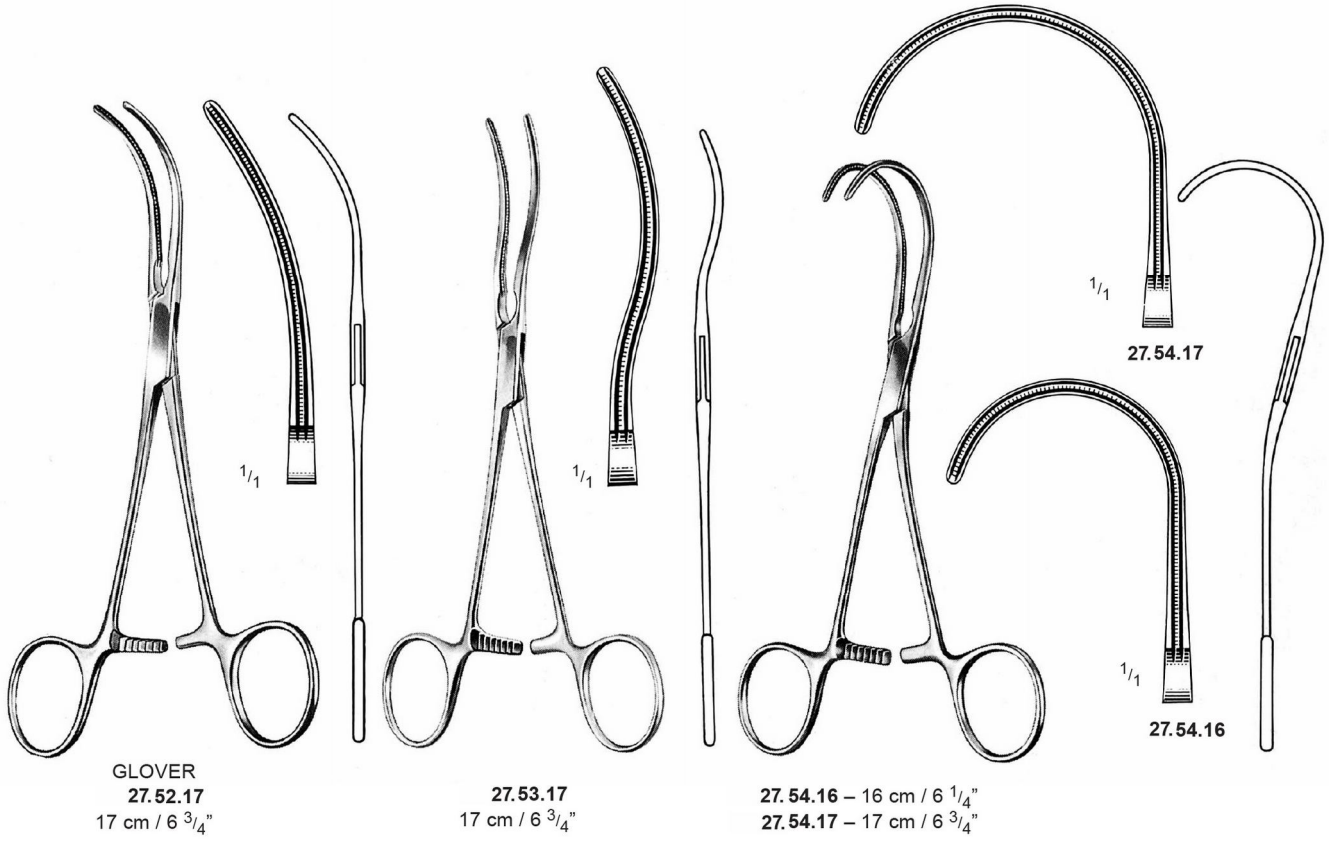

Atraumatic Bulldog Clamps

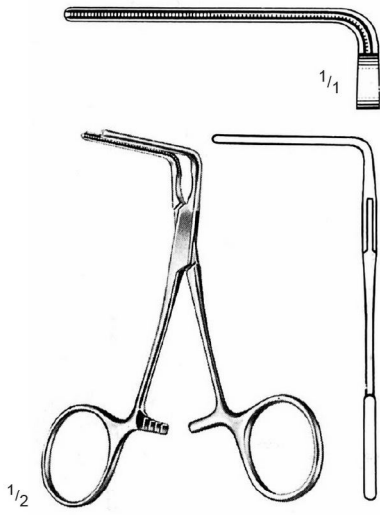

DE BAKEY
27.57.10
10 cm / 4"

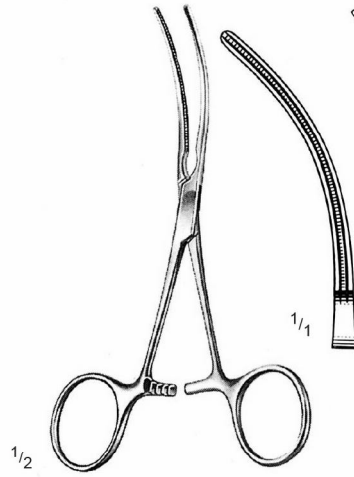

DE BAKEY
27.58.11
11 cm / 4 1/4"

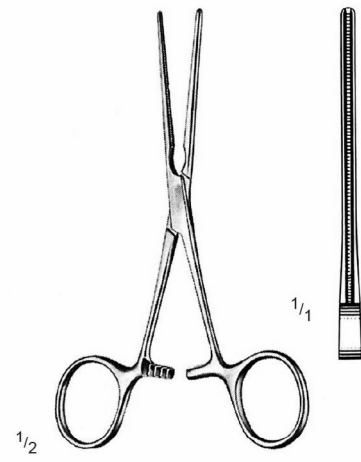

DE BAKEY
27.59.12
12 cm / 4 3/4"

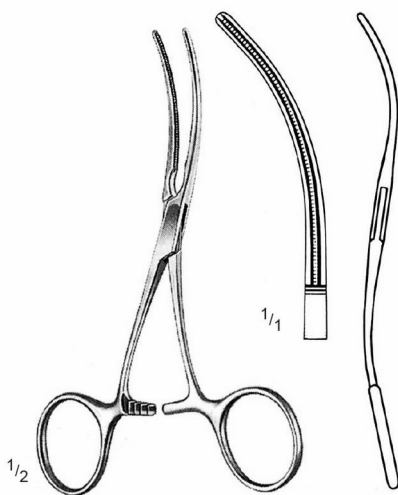

DE BAKEY
27.60.12
12 cm / 4 3/4"

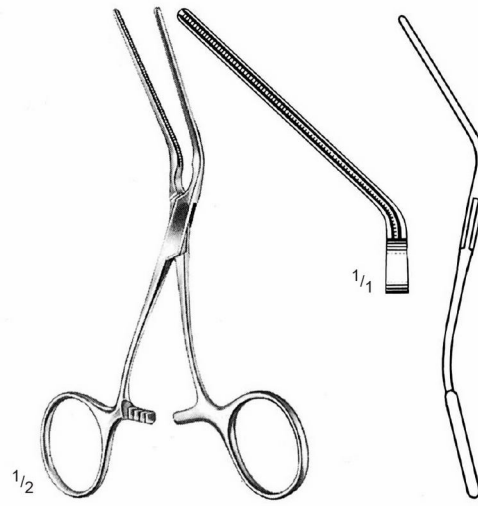

DE BAKEY
27.61.13
13 cm / 5"

Vascular Dilators

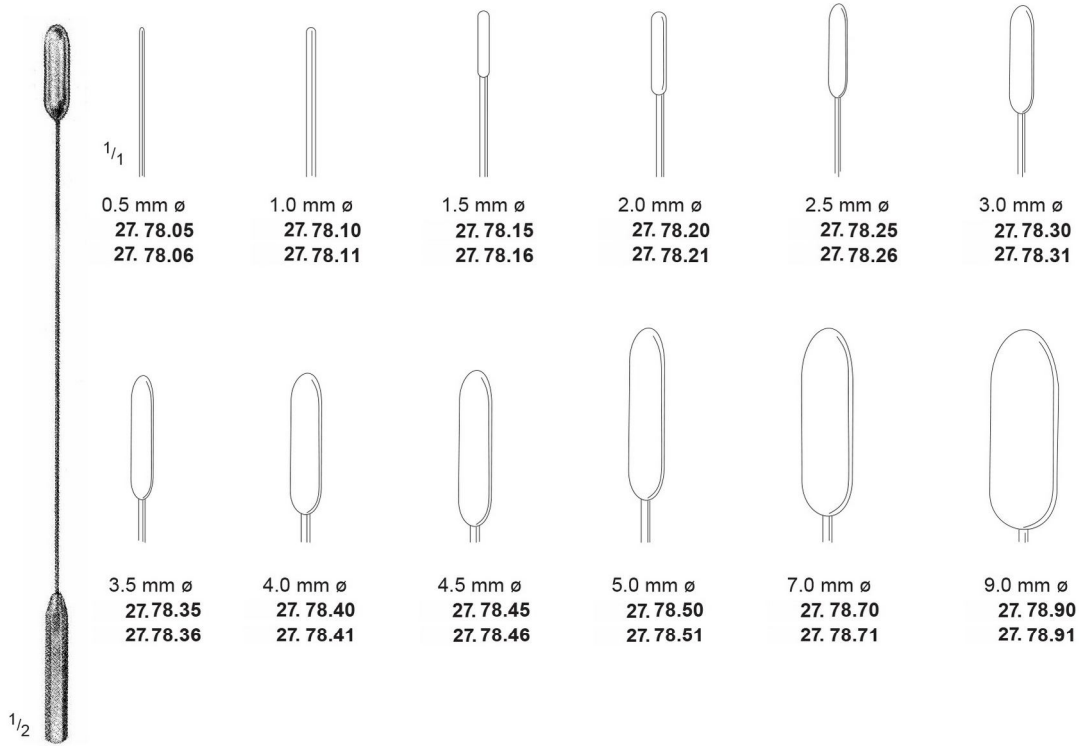

DE BAKEY

27.78.05 – 27.78.90 = 19 cm / 7 1/2"
27.78.06 – 27.78.91 = 35 cm / 14"



GARRETT
14 cm / 5 1/2"
27.79.190
Set of 9 pieces from
27.79.110 to 27.79.150

27.79.110	ø 1,0 mm
27.79.115	ø 1,5 mm
27.79.120	ø 2,0 mm
27.79.125	ø 2,5 mm
27.79.130	ø 3,0 mm
27.79.135	ø 3,5 mm
27.79.140	ø 4,0 mm
27.79.145	ø 4,5 mm
27.79.150	ø 5,0 mm



GARRETT
21 cm / 8 1/4"
27.79.290
Set of 9 pieces from
27.79.210 to 27.79.250

27.79.210	ø 1,0 mm
27.79.215	ø 1,5 mm
27.79.220	ø 2,0 mm
27.79.225	ø 2,5 mm
27.79.230	ø 3,0 mm
27.79.235	ø 3,5 mm
27.79.240	ø 4,0 mm
27.79.245	ø 4,5 mm
27.79.250	ø 5,0 mm

Aorta Dilators

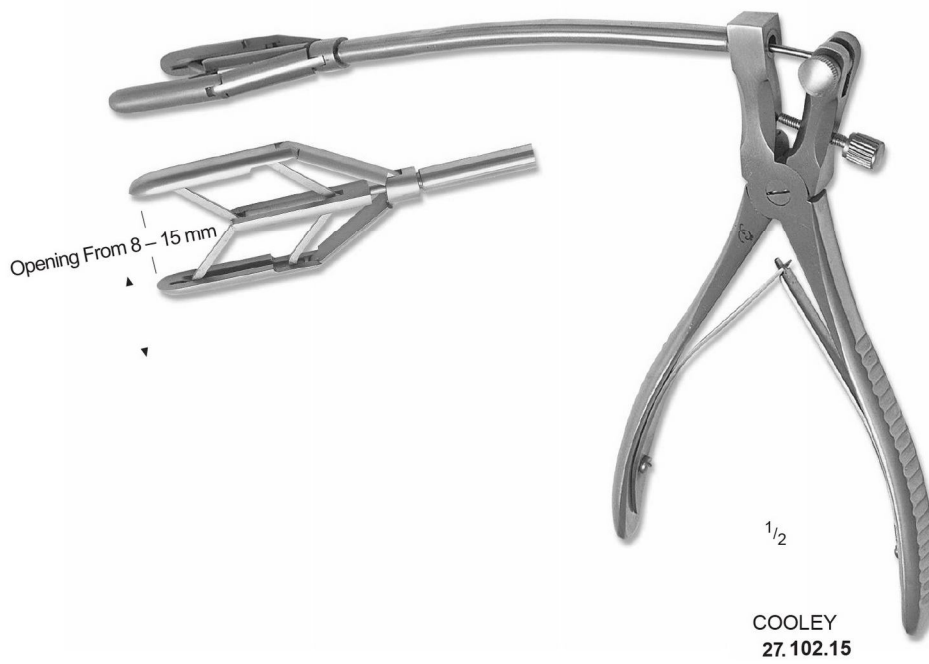
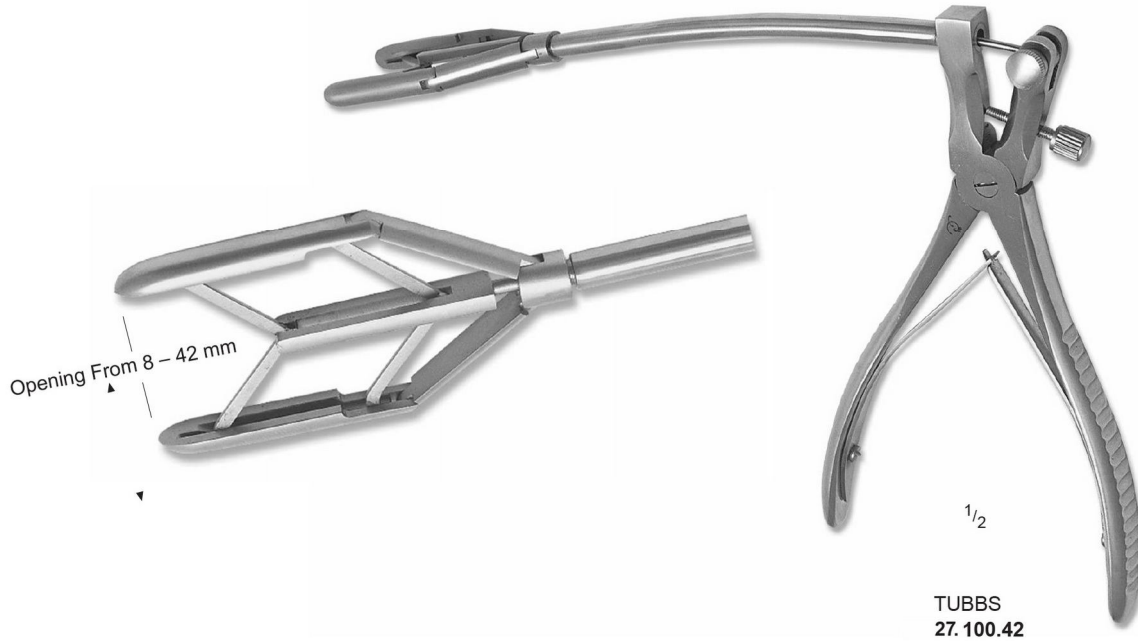

Vascular Scissors, with Tungsten Carbide T/C Inserts

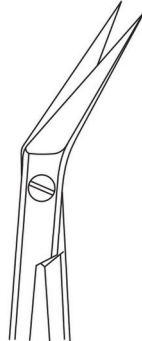

27.83.42
25°

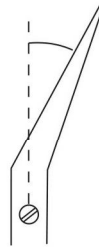

27.83.92
25°

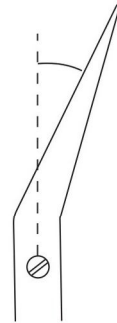

27.83.97
25°

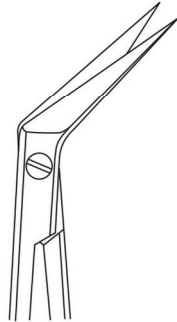

27.83.44
45°

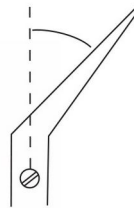

27.83.93
45°

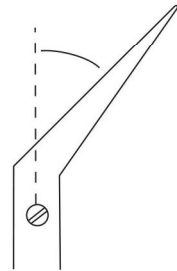

27.83.98
45°

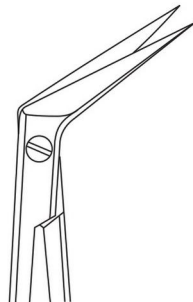

27.83.46
60°

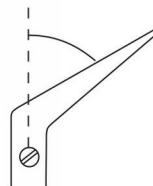

27.83.96
60°

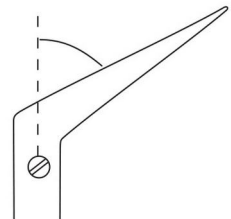

27.83.99
60°

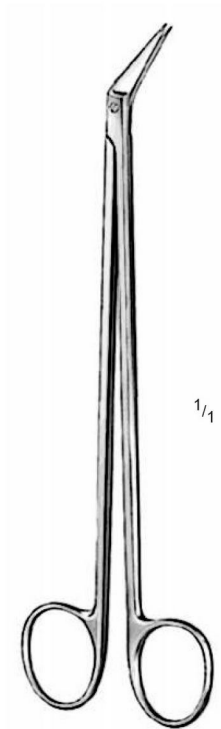

POTTS SMITH
27.83.42 - 27.83.46
19 cm / 7 1/2"

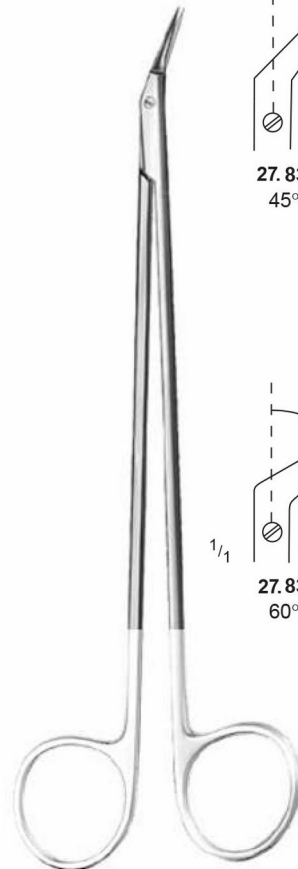

POTTS SMITH, T/C
27.83.92 - 27.83.96
19 cm / 7 1/2"

27.83.97 - 27.83.99
23 cm / 9"

Vascular Scissors



27.87.32
18 cm / 7"
25°



27.87.34
18 cm / 7"
45°



27.87.39
17 cm / 6 3/4"
90°

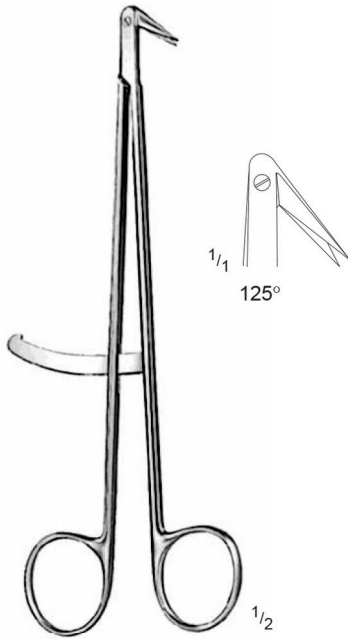

DIETRICH
27.85.41
18 cm / 7"

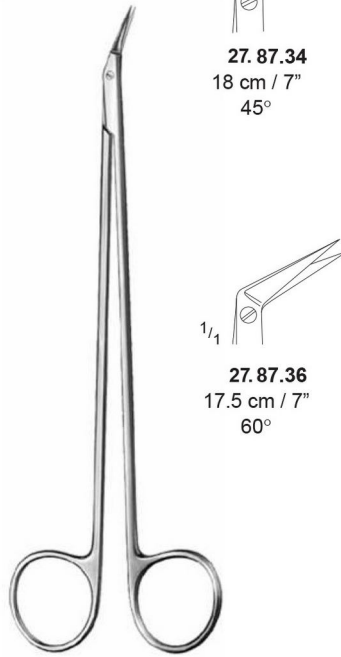

DIETRICH
27.87.32 - 27.87.40

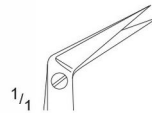

27.87.36
17.5 cm / 7"
60°



27.87.40
17 cm / 6 3/4"
125°