

Knives, Scalpels
Messer, Skalpelle
Bisturies
Bistouris
Bisturi

Scissors
Scheren
Tijeras
Ciseaux
Forbici

Forceps, Hemostatic Forceps
Pinzetten, Arterienklemmen
Pinzas, Pinzas hemostaticas
Pinces, Pinces hémostatiques
Pinzette, Pinze emostatiche

Needle holders
Nadel halter
Portagujas
Porte-aiguilles
Porta aghi

Retractors
Wundhaken
Separadores
Ecarteurs
Retrattori

Bone Cutting Forceps,
Bone Rongeurs
Hohlemeißelzangen,
Knochen Splitterzangen
Pinzas Cortentes para huesos
Pinces á os coupantes,
Pinces-gouges
Scalpellini e pinze alveolotome



Tel# 0092-52-4260785
Fax# 0092-52-4266804
Email. Info@benison.com.pk

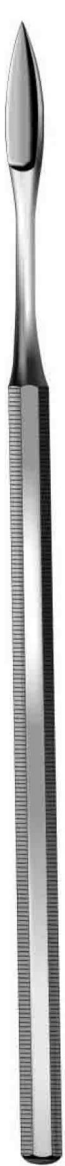

Ash
PE.25.01-
PE.25.03



1/1
PE.25.01
Fig. 1



PE.25.02
Fig.2



PE.25.03
Fig.3



1/1
PE.03.10
Fig.10

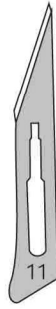

PE.03.11
Fig.11



Standard
PE.04.03
No.3



PE.09.04
No.4



PE.06.17
No.7K



PE.05.07
No.7



PE.10.40
No.3
straight

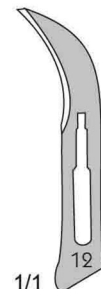

1/1
PE.03.12
Fig.12

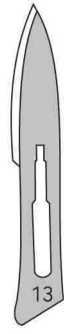

PE.03.13
Fig.13



1/1
PE.03.14
Fig.14

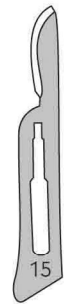

PE.03.15
Fig.15



Standard
PC.14.14
PC.14.64 "TC"
PC.18.14.
PC.18.64 "TC"
14,5 cm/ 5 3/4"
Blunt/ Blunt



Standard
PC.15.14
PC.15.64 "TC"
PC.19.14
PC.19.64 "TC"
14,5 cm/ 5 3/4"
Sharp/ Sharp



Standard
PC.16.14
PC.16.64 "TC"
PC.17.14
PC.17.64 "TC"
14,5 cm/ 5 3/4"
Sharp/ Blunt



Metzenbaum
PC.36.14
14,5 cm/ 5 3/4"



Metzenbaum
PC.37.14
14,5 cm/ 5 3/4"

Gum Scissors
Zahnfleischscheren
Tijeras para encias
Ciseaux á gengives
Forbrci per gengiva



Metzenbaum-Delicate
PC.42.14 14,5 cm/ 5 3/4"
PC.44.18 18 cm/ 7"



Metzenbaum-Delicate
PC.43.14 14,5 cm/ 5 3/4"
PC.45.18 18 cm/ 7"



PC.01.11-PC.08.91
11,5 cm/ 4 1/2"



PC.01.11

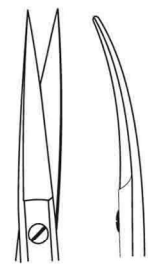

PC.02.11



PC.08.90



PC.08.91

Gum Scissors
Zahnfleissscheren
Tijeras para encias
Ciseaux á gengives
Forbici per gengiva

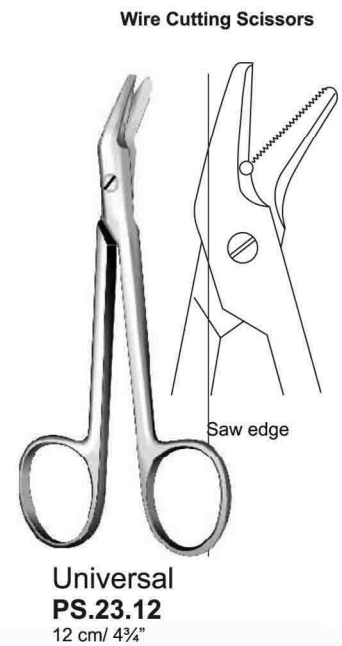
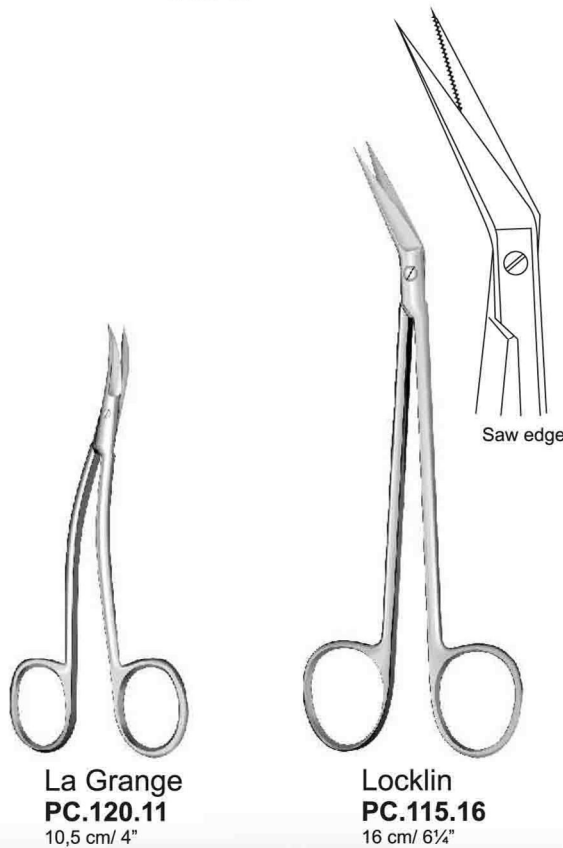
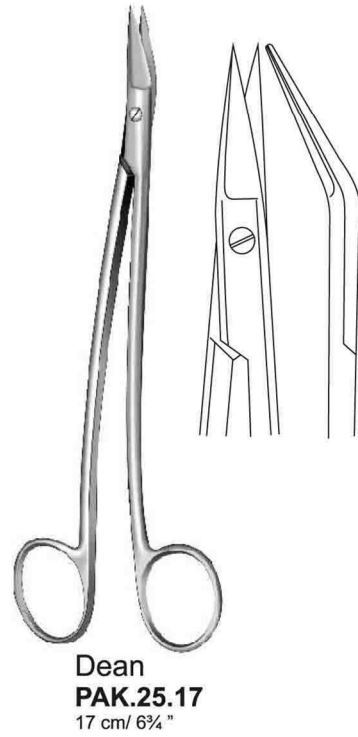
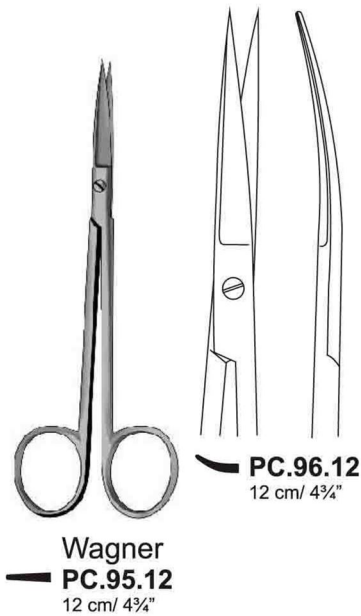
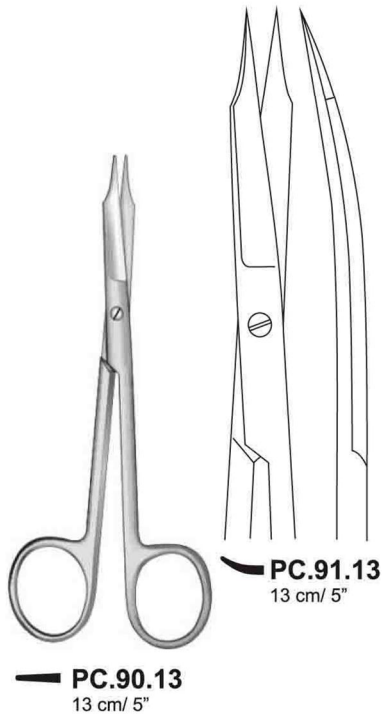

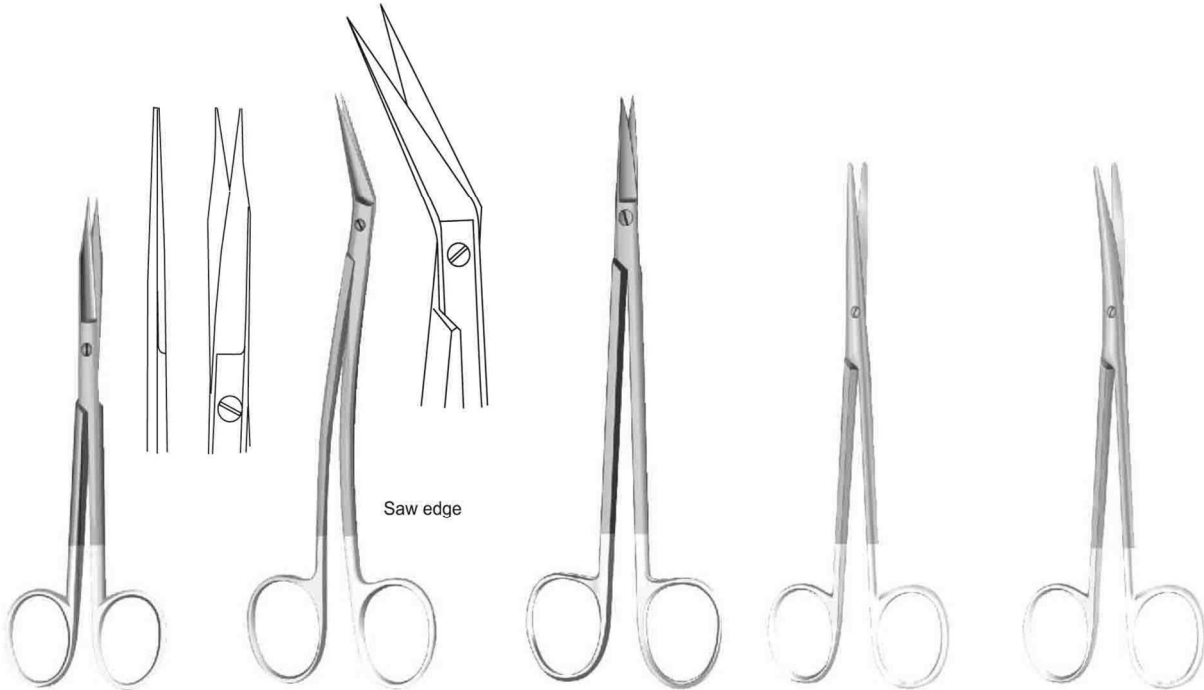





PC.91.53
13 cm / 5"

Locklin
PC.115.66
16 cm / 6 1/4"

Kelly
 **PC.46.66** 16 cm / 6 1/4"
 **PC.47.66** 16 cm / 6 1/4"

Metzenbaum
 **PC.36.64** 14 cm / 5 1/2"
 **PC.37.64** 14 cm / 5 1/2"
 **PC.38.70** 20 cm / 8"
 **PC.39.70** 20 cm / 8"

Metzenbaum-Fine
 **PC.42.64** 14 cm / 5 1/2"
 **PC.43.64** 14 cm / 5 1/2"
 **PC.44.70** 20 cm / 8"
 **PC.45.70** 20 cm / 8"

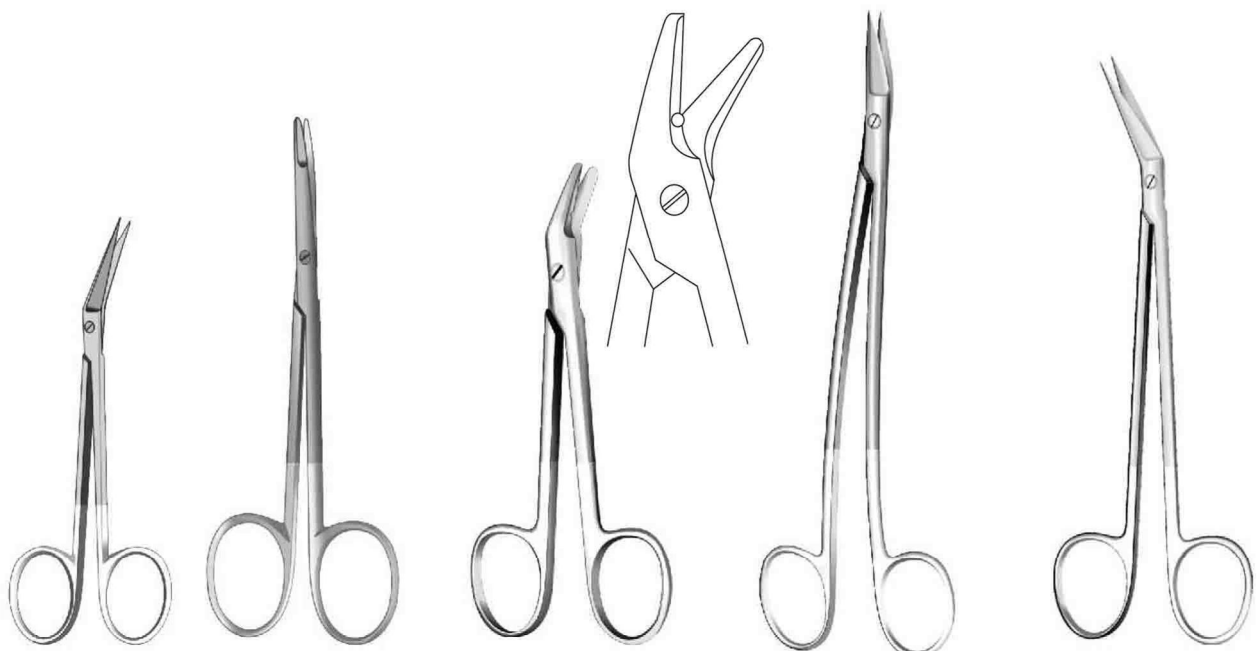

PC.08.92
11,5 cm / 4 1/2"

Ragnell (Killner)
PC.59.63
13 cm / 5 1/2"

Universal
PS.24.12
12 cm / 4 3/4"

Dean
PAK.25.57
17 cm / 6 3/4"

Locklin
PC.115.66
16 cm / 6 1/4"
Saw Edge

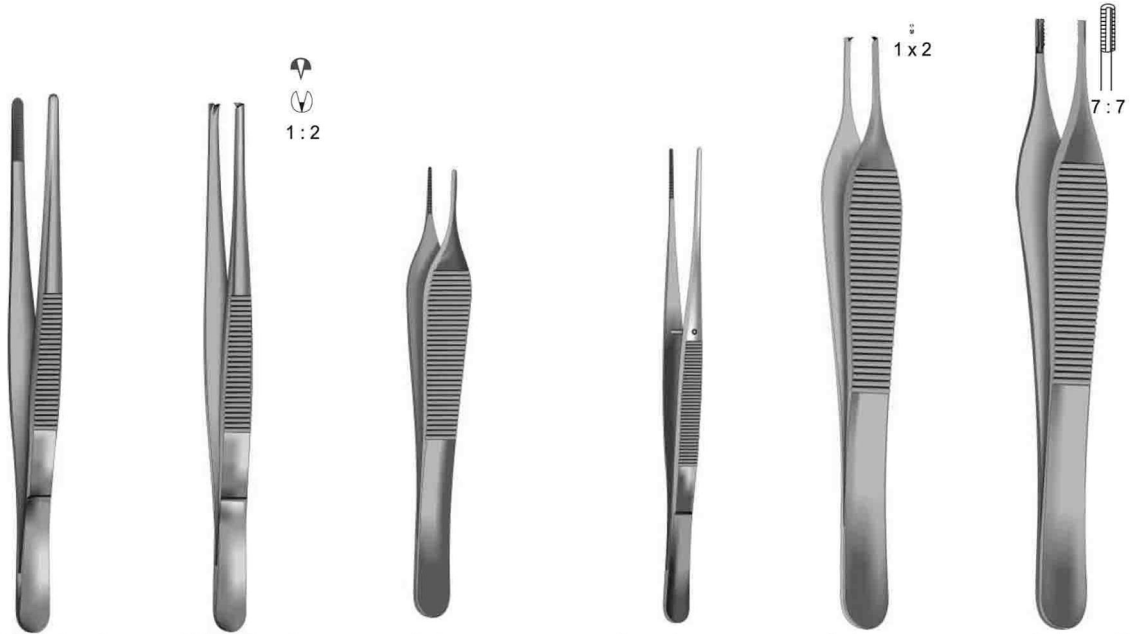

	Standard	Standard	Adson	Semken	Adson	Adson Brown
12 cm/ 4¾"	PF.01.11	PF.05.11	PF.15.12	PF.30.15	PF.16.12	PF.21.12
14.5cm/ 5¾"	PF.01.14	PF.05.14		15.5 cm/ 6"	PF.16.15	PF.21.15
15cm/ 6"	PF.01.15	PF.05.15	PF.15.15			
16 cm/ 6¼"	PF.01.16	PF.05.16				
18 cm/ 7"	PF.01.18	PF.05.18				
20 cm/ 8"	PF.01.20	PF.05.20				
25 cm/ 10"	PF.01.25	PF.05.25				

With Tungsten Carbide "TC"

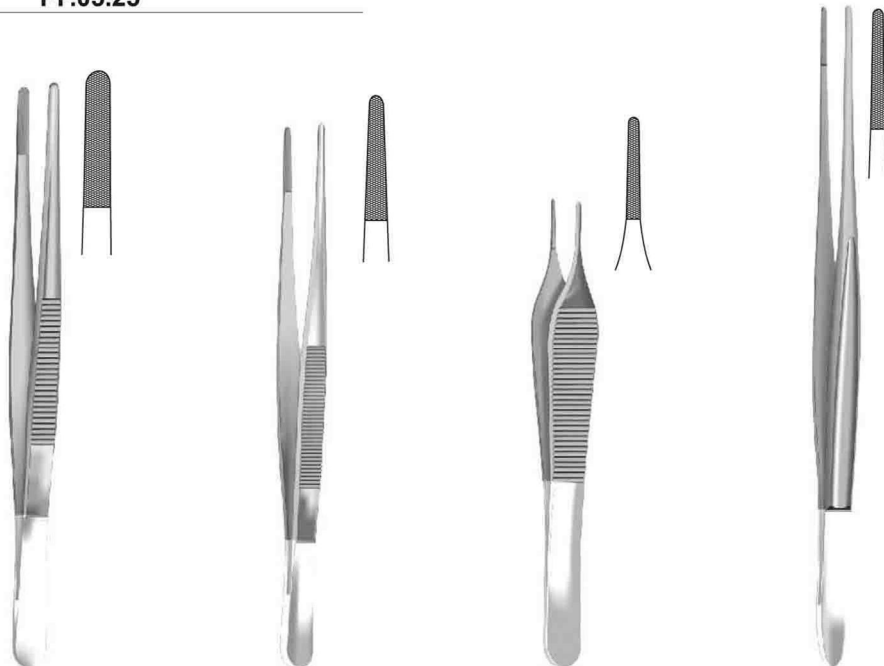

	Standard "TC"	Narrow "TC"	Adson "TC"	Cushing "TC"
12 cm/ 4¾"	PF.01.62	PF.03.62	PF.15.62	PF.52.67
14.5cm/ 5¾"	PF.01.64	PF.03.64		17cm/ 6¾"
15cm/ 6"	PF.01.65		PF.15.65	
16 cm/ 6¼"	PF.01.66	PF.03.66		
18 cm/ 7"	PF.01.68	PF.03.68		

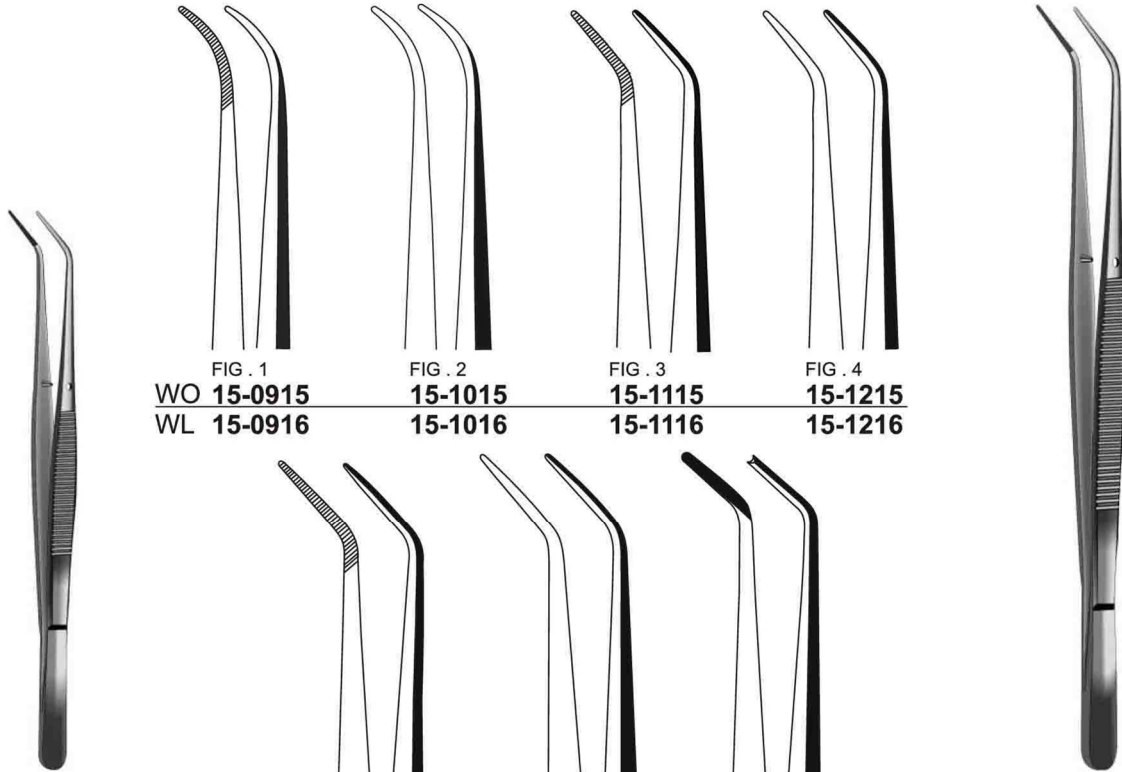

FIG . 1	FIG . 2	FIG . 3	FIG . 4
WO 15-0915	15-1015	15-1115	15-1215
WL 15-0916	15-1016	15-1116	15-1216

London College
 15 cm/ 6"
15-0915 - 15-1515
 WO: Without Lock
15-0916 - 15-1516
 WL: With Lock

FIG . 5	FIG . 6	FIG . 7
WO 15-1315	15-1415	15-1515
WL 15-1316	15-1416	15-1516

Flagg
 16 cm/ 6¼"
15-1616 Smooth
15-1626 Serrated

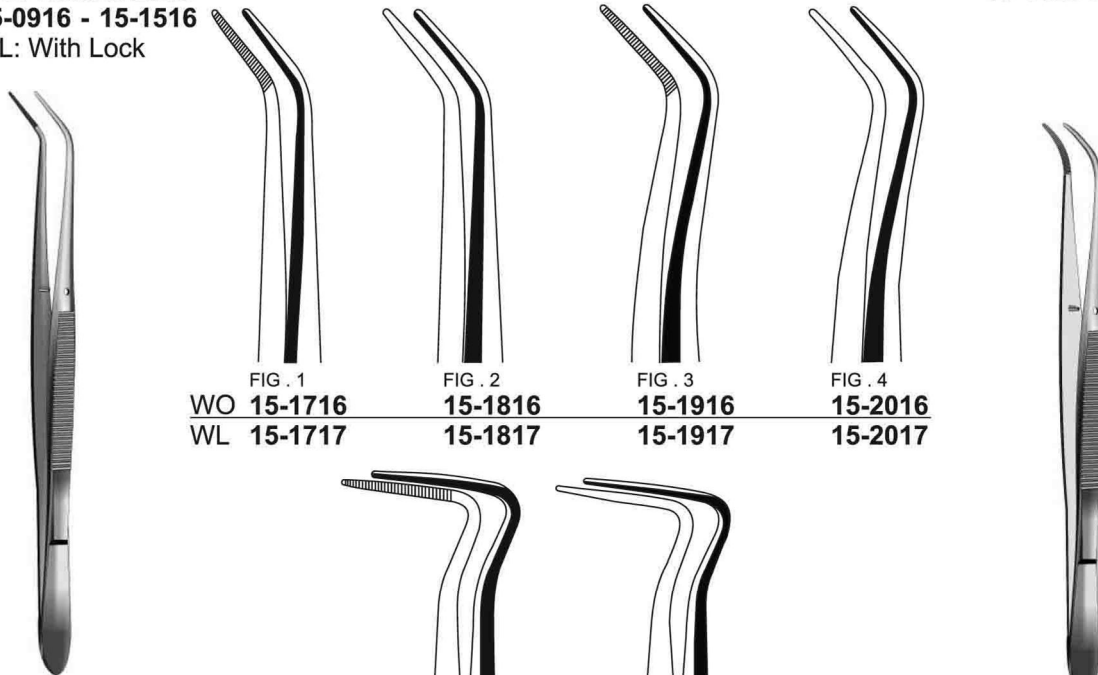

FIG . 1	FIG . 2	FIG . 3	FIG . 4
WO 15-1716	15-1816	15-1916	15-2016
WL 15-1717	15-1817	15-1917	15-2017

Meriam
 16 cm/ 6¼"
15-1716 - 15-2216
 WO: Without Lock
15-1717 - 15-2217
 WL: With Lock

FIG . 5	FIG . 6
WO 15-2116	15-2216
WL 15-2117	15-2217

Perry
 13 cm/ 5"
15-2410 Serrated
15-2413 Smooth



Albrecht
15-2516 Sharp
15-2517 Blunt
16 cm/ 6¼"

USA-Mod.
15-2615
15 cm/ 6"

15-2715
15 cm/ 6"

Caulk
15-2815
16,5cm/ 6½"

15-2915
15 cm/ 6"

Articulating Forceps

Miller
15-3415
15cm/ 6 "

USA-Mod.
15-3016
16 cm/ 6¼"

USA-Mod.
15-3116
16 cm/ 6¼"

USA-Mod.
15-3216
16 cm/ 6¼"

Crane-Keplan
15-3301
14 cm/ 5½"

Crane-Keplan
15-3302
14 cm/ 5½"



Jones
PI.19.06 6 cm/ 2 1/2"
PI.20.09 9 cm/ 3 1/2"



Backhaus
PI.25.08 8 cm/ 3 1/4"
PI.25.10 11 cm/ 4 1/2"
PI.26.13 13 cm/ 5"

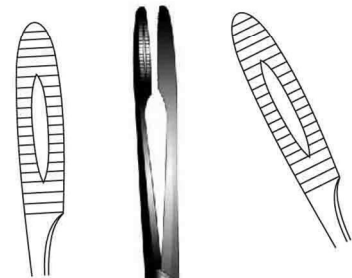

PG.11.20
PG.13.26

PG.12.20
PG.14.26

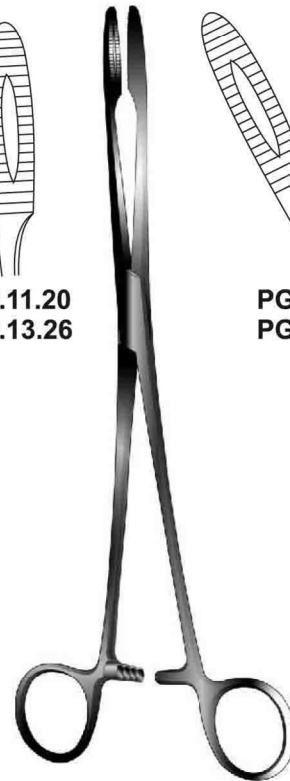

Gross-Maier
PG.11.20 - PG.13.26
PG.12.20 - PG.14.26
20cm/ 8" 26cm/ 10 1/4"

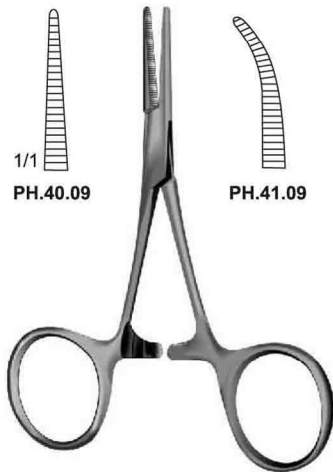

1/1
PH.40.09

PH.41.09

Hartmann
PH.40.09 - PH.41.09
10 cm/4" Straight 10 cm/4" Curved



PH.10.12

PH.11.12

Halstead
PH.10.12 - PH.11.12
12 cm/4 3/4" Straight 12 cm/4 3/4" Curved

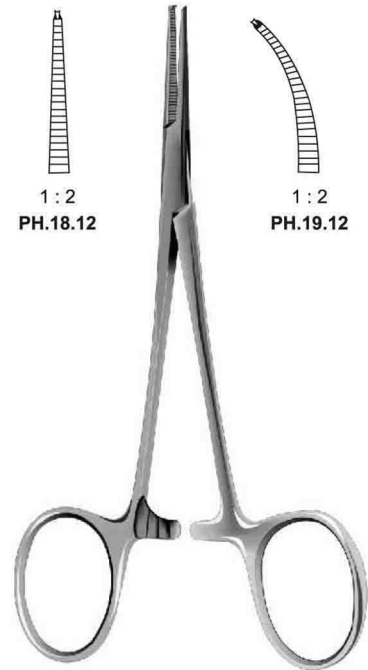

1 : 2
PH.18.12

1 : 2
PH.19.12

Halsted-Mosquito
PH.18.12 - PH.19.12
12,5 cm/5" Straight 12 cm/5" Curved

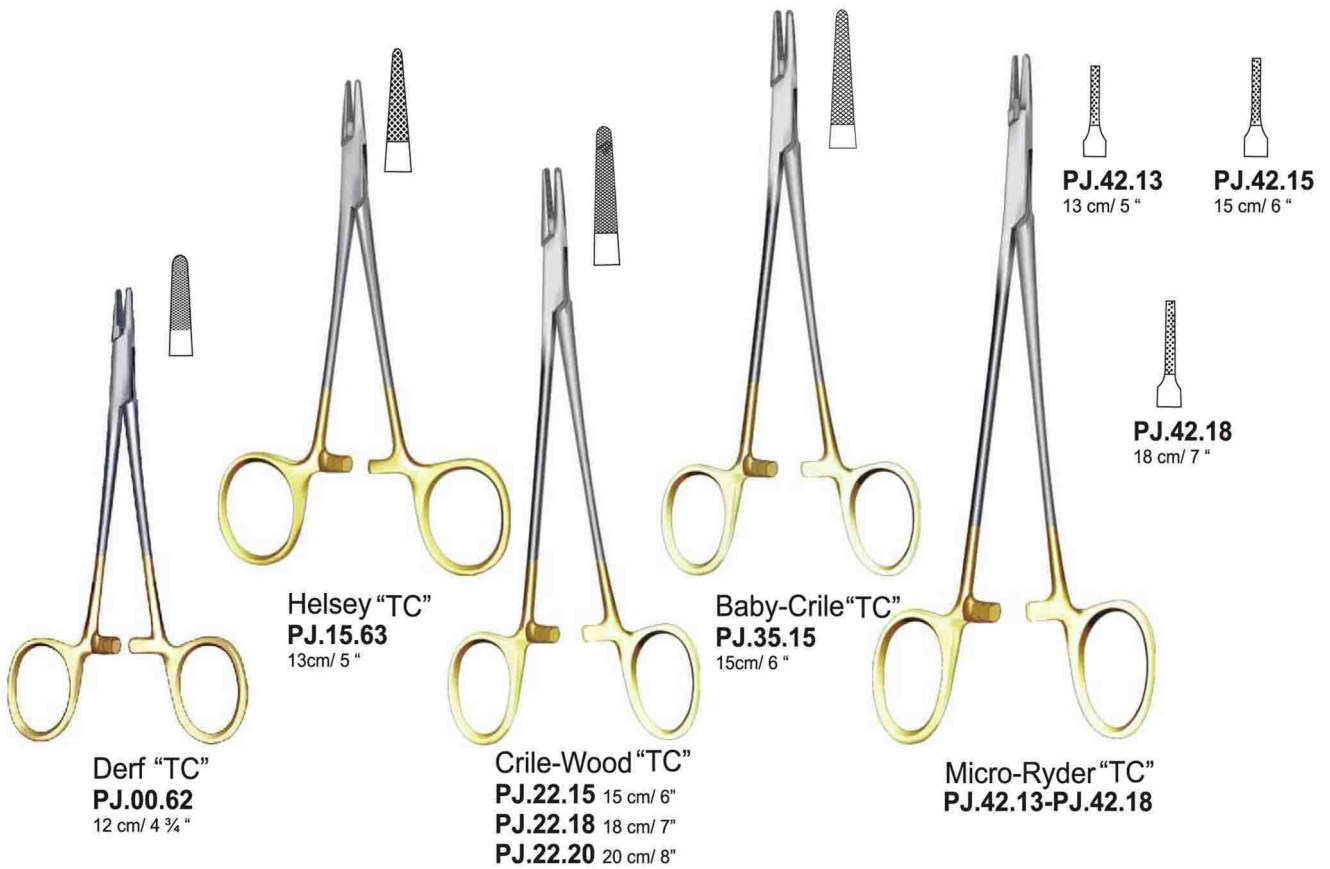



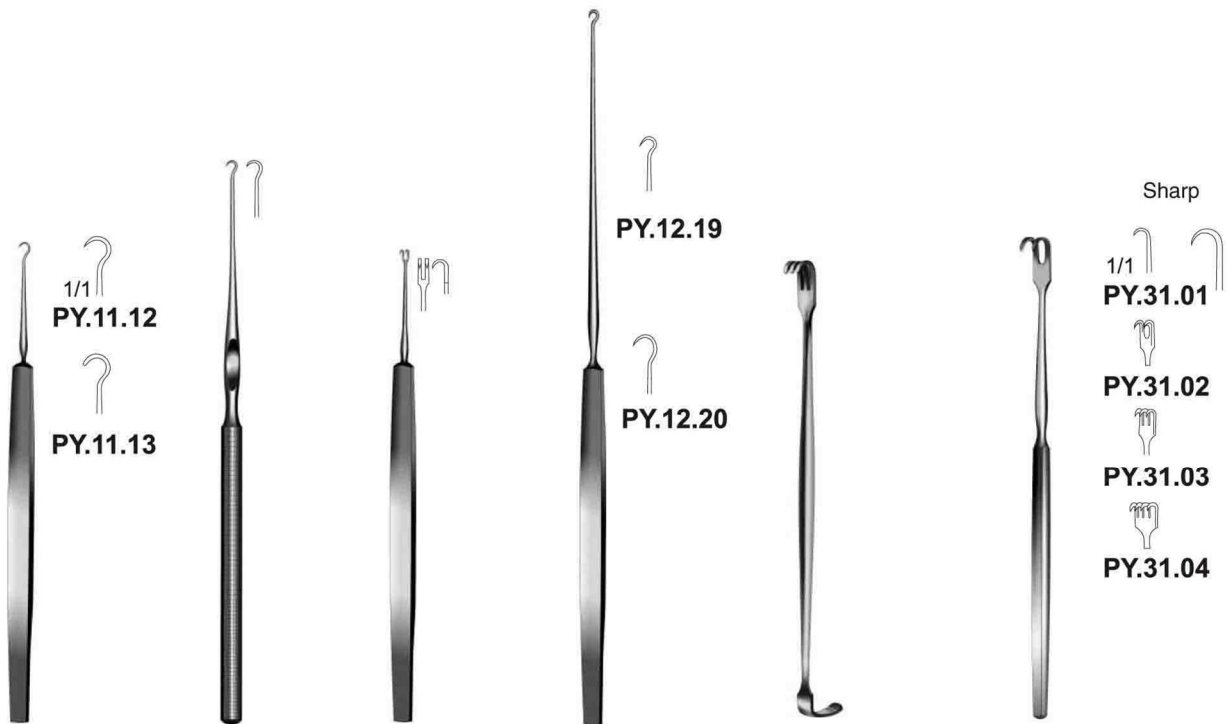

Frazier
PY.11.12-
PY.11.13
13 cm/ 5 ¼"

Kilner
PAE.11.15
15 cm/ 6 "

Guthrie
PY.25.13
13 cm/ 5"

Gillies
PY.12.19-
PY.12.20
19 cm/ 7"

Senn-Miller
PY.01.16
16 cm/ 6¼"

PY.31.01 -
PY.31.04
16 cm/ 6¼"

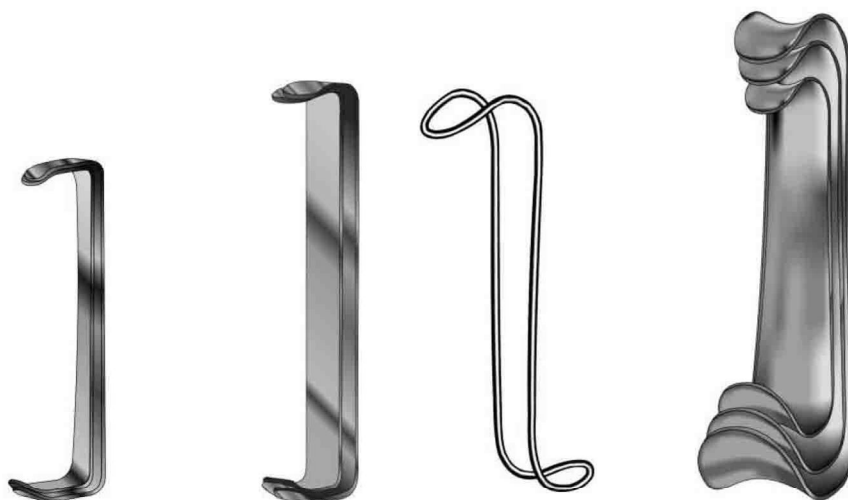

Farabeuf
PY.46.12
12 cm/ 4 ¾"

Farabeuf
PY.47.15
15 cm/ 5"

Collin-Hartmann
PY.45.14 14 cm/ 5 ½"
PY.45.16 16 cm/ 6 ¼"

Roux
Roux Set of 3.
PY.49.00 Set of 3
PY.49.01 Fig.1
PY.49.02 Fig.2
PY.49.03 Fig.3

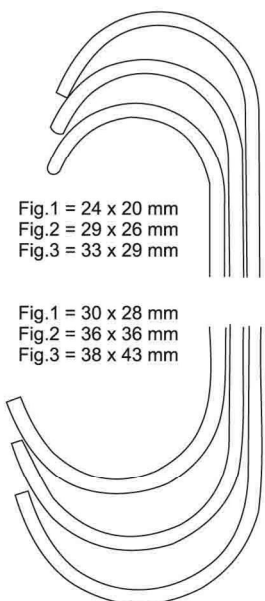
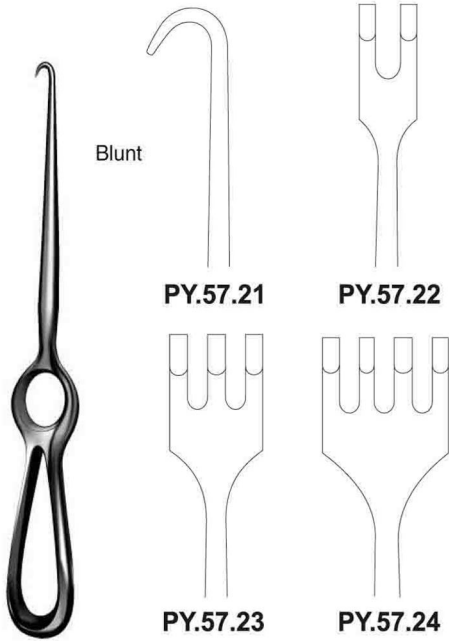

Fig.1 = 24 x 20 mm
Fig.2 = 29 x 26 mm
Fig.3 = 33 x 29 mm

Fig.1 = 30 x 28 mm
Fig.2 = 36 x 36 mm
Fig.3 = 38 x 43 mm



Blunt

PY.57.21

PY.57.22

PY.57.23

PY.57.24



11 x 40 mm PAS.12.40

11 x 55 mm PAS.12.55

11 x 80 mm PAS.12.80

Volkmann
PY.57.21-PY.57.24
21.5 cm/ 8 1/2"

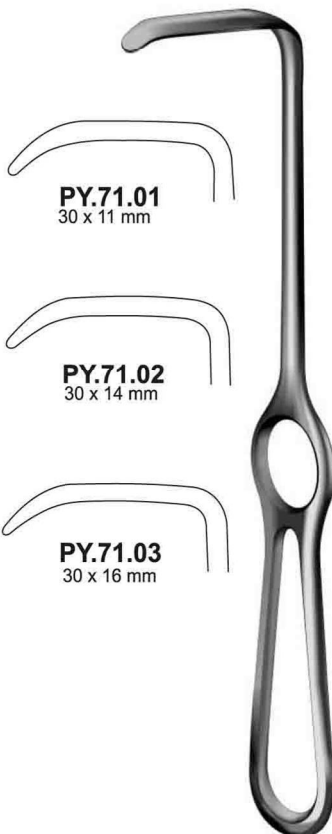

PY.71.01
30 x 11 mm

PY.71.02
30 x 14 mm

PY.71.03
30 x 16 mm

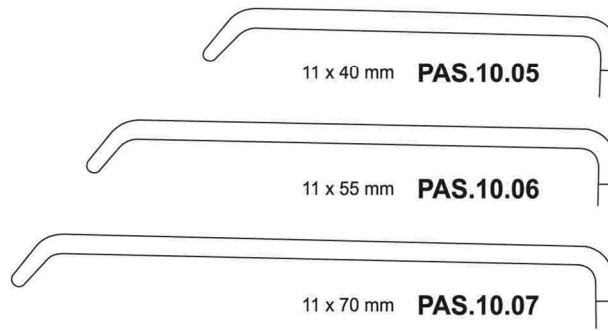

11 x 40 mm PAS.10.05

11 x 55 mm PAS.10.06

11 x 70 mm PAS.10.07

Obwegeser
PAS.12.40-
PAS.12.80
22 cm/8 3/4"

Langenbeck
PY.71.01- PY.71.03
21cm/ 8 1/4"

Obwegeser
PAS.10.05 -
PAS.10.07
21,5 cm/8 1/2"



Williger
PT.11.17
17 cm/6 3/4"



Williger
PT.12.04
16 cm/6 1/4"



Freer
PAM.28.21
21.5 cm/ 8 1/2"



PT.19.20
17,5 cm/7"



Molt
PT.19.21
19 cm/7 1/2"

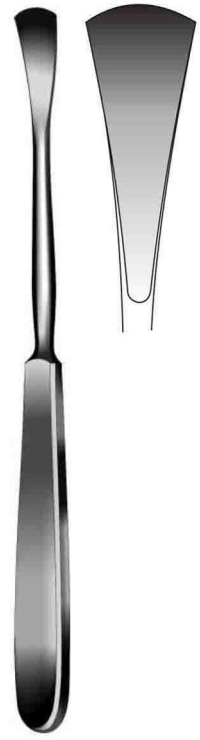

Lengenbeck
PT.37.35
19 cm/7 1/2"

Bone Nibblers.

- 1mm
PAC.37.01
- 2mm
PAC.37.02
- 3mm
PAC.37.03



Citelli
PAC.37.01-
PAC.37.03
17 cm/6 3/4"

- 4 x 4 mm
PAC.36.01
- 5 x 5 mm
PAC.36.02
- 6 x 6 mm
PAC.36.03

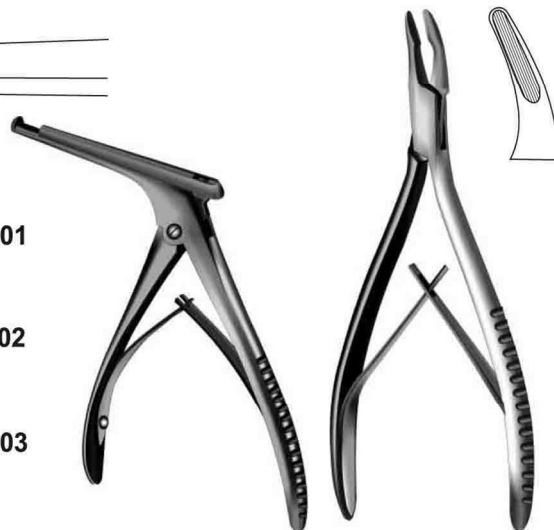

Kerrison
PAC.36.01-
PAC.36.03

Friedman
PX.01.14
14 cm/5 1/2"

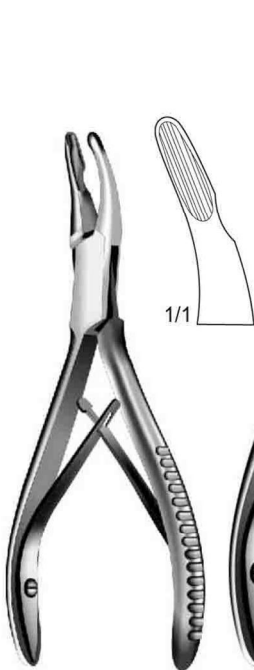

Cleveland
PX.04.14
14 cm/5 1/2"



Cleveland 4A
PX.04.17
17 cm/6 3/4"



Luer
PX.20.65
15 cm/6"



Luer
PX.20.75
15 cm/6"

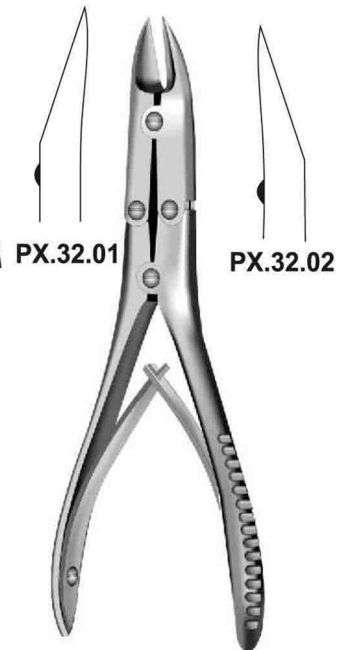

Bohler
PX.32.01-PX.32.02
15 cm/6"

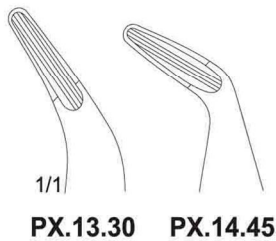

PX.13.30 PX.14.45



PX.15.90

Blumenthal
PX.13.30-
PX.15.90
16 cm/6"

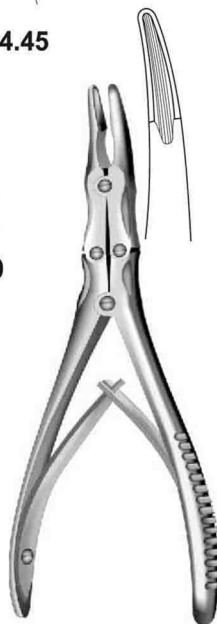

Beyer
PX.31.16
15,5 cm/6"



Beyer
PX.31.18
18 cm/7"



Cleveland 5 S
PU.04.14
14cm/5 1/2"



Cleveland 5
PU.05.17
17 cm/6 3/4"

Dermal Punch, Probes Gauze Packer
 Lip Retractor Tongue Depressor
 Hauttrephines Knopfsonden Tamponstopfer
 Lippenhalter, Zungenspatel
 Trepanos Cutaneos estiletos abotonados,
 Taponadoresl Separadores de los labios bajaleguas
 Trepans cutanes sondes porte
 tampones ecarteurs des levres
 Aspiratori per soliva porta tamponi, Separatore
 del labbro, Spatola per Lingua

- 2 mm ○ PAE.10.62
- 3 mm ○ PAE.10.63
- 4 mm ○ PAE.10.64
- 5 mm ○ PAE.10.65
- 6 mm ○ PAE.10.66
- 7 mm ○ PAE.10.67
- 8 mm ○ PAE.10.68



Keyes
PAE.10.62-
PAE.10.68



Farrell Ø 0.9 mm
PB.16.12 12 cm/ 4 ¾"
PB.16.14 14 cm/ 5 ½"
PB.16.16 16 cm/ 6 ¼"



Bowmann
PAB.94.00
Set of 4
PAB.94.01 Fig 1+2
PAB.94.03 Fig 3+4
PAB.94.05 Fig 5+6
PAB.94.07 Fig 7+8



Ø 1.5 mm	Ø 2 mm	
PB.01.10	PB.02.10	11 cm/ 4 ¼"
PB.01.13	PB.02.13	13 cm/ 5"
PB.01.14	PB.02.14	14 cm/ 5 ½"
PB.01.16	PB.02.16	16 cm/ 6 ¼"



Luniatchek
PAK.30.19
 19 cm/7 ½"



Luniatchek
PAK.30.20
 19 cm/7 ½"

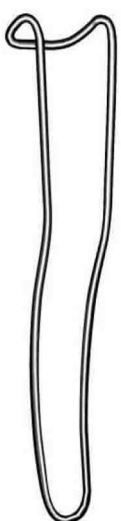

Sternberg
PAS.03.15
 14 cm/5 ½"

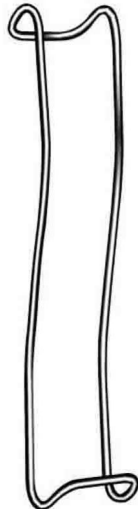

Sternberg
PAS.03.16
 16 cm/6 ¼"



Bruenings
PAS.05.18
 19 cm/7 ½"



PAS.03.16
 Wood
 16 cm/ 6 ¼"



Kroenig
PAS.03.14
 15 cm/6"



Mayo
PAS.04.17
 17 cm/6 ¼"

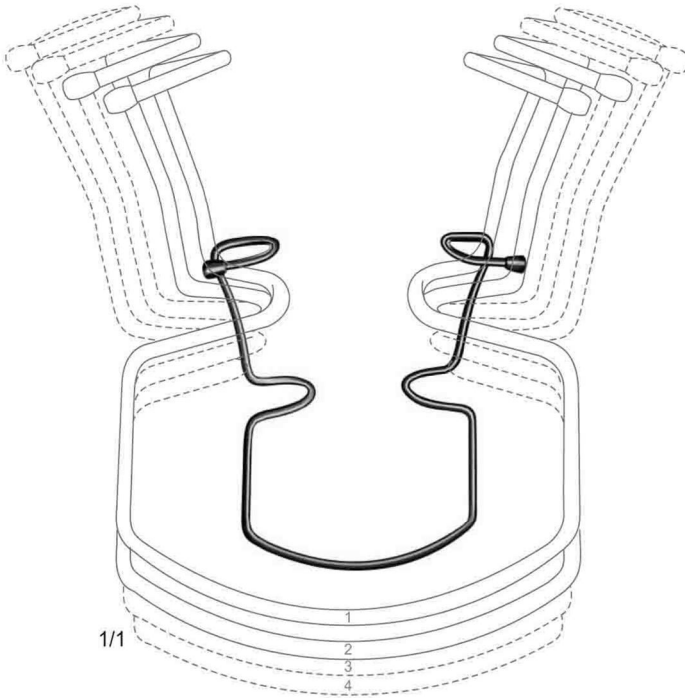

Oringer
PAQ.01.00 Fig.1
PAQ.01.02 Fig.2
PAQ.01.03 Fig.3
PAQ.01.04 Fig.4
PAQ.01.13 Set of 4

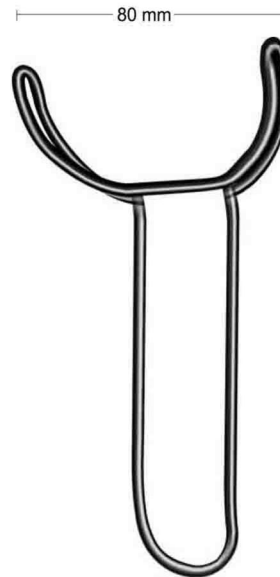

Vestibelum-Haken
PAQ.01.15
15cm/ 6"



Heister
PAQ.05.05
13 cm/ 5"

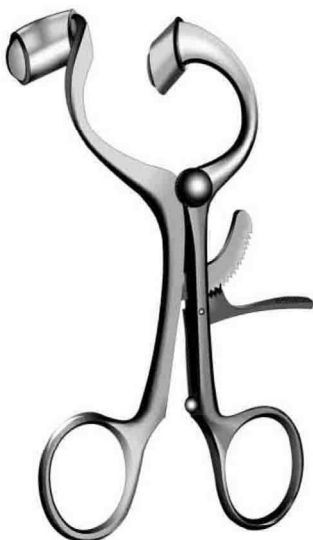

Molt
PAQ.07.15
15cm/6"



Jennings
PAQ.09.09 9 cm/ 3 1/2"
PAQ.09.11 11 cm/ 4 1/4"
PAQ.09.13 13 cm/ 5"
PAQ.09.15 15 cm/ 6"



Roser-Konig
PAQ.13.45 16 cm/6 1/4"
PAQ.13.50 20 cm/7 1/2"



Denhart
PAQ.14.60
13 cm/5"

 Fig. 1
PV.37.11

 Fig. 21
PV.37.12

 Fig. 31
PV.37.14
Passow
PV.37.11-
PV.37.14
 12 cm/ 4 3/4"

Parsch
 13,5 cm/5 1/2"

17 cm/6 3/4"

Parsch
 13,5 cm/5 1/2"

17 cm/6 3/4"

	PV.05.03	PV.05.53	PV.06.03	PV.06.53
3 mm	PV.05.03	PV.05.53	PV.06.03	PV.06.53
4 mm	PV.05.04	PV.05.54	PV.06.04	PV.06.54
5 mm	PV.05.05	PV.05.55	PV.06.05	PV.06.55
6 mm	PV.05.06	PV.05.56	PV.06.06	PV.06.56



4 mm

PAN.28.04

7 mm

PAN.28.07

12 mm

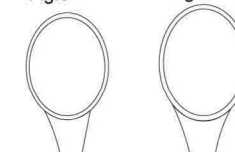
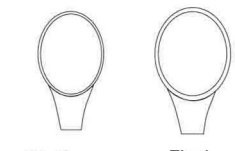
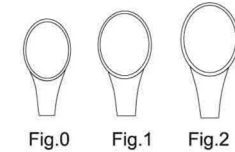
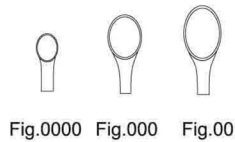
PAN.28.12
Cottle
PAN.28.04-
PAN.28.12

Volkmann
PW.14.22-PW.14.56
 17 cm/6 3/4"

PW.21.10
PW.21.11
PW.21.12
Williger
PW.21.10-
PW.21.12
 13,5 cm/5 1/4"

Parsch
PW.30.15
 15 cm/6"

Fig. 1

Parsch
PW.31.15
 15 cm/6"

Fig. 2

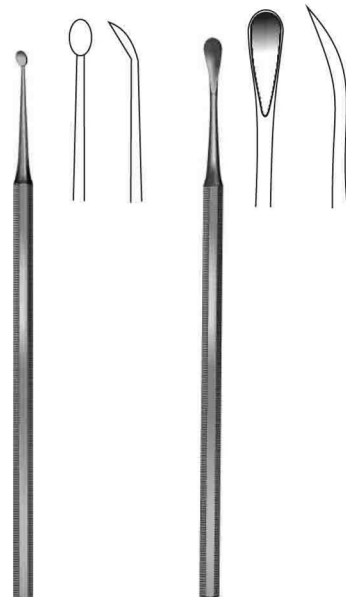
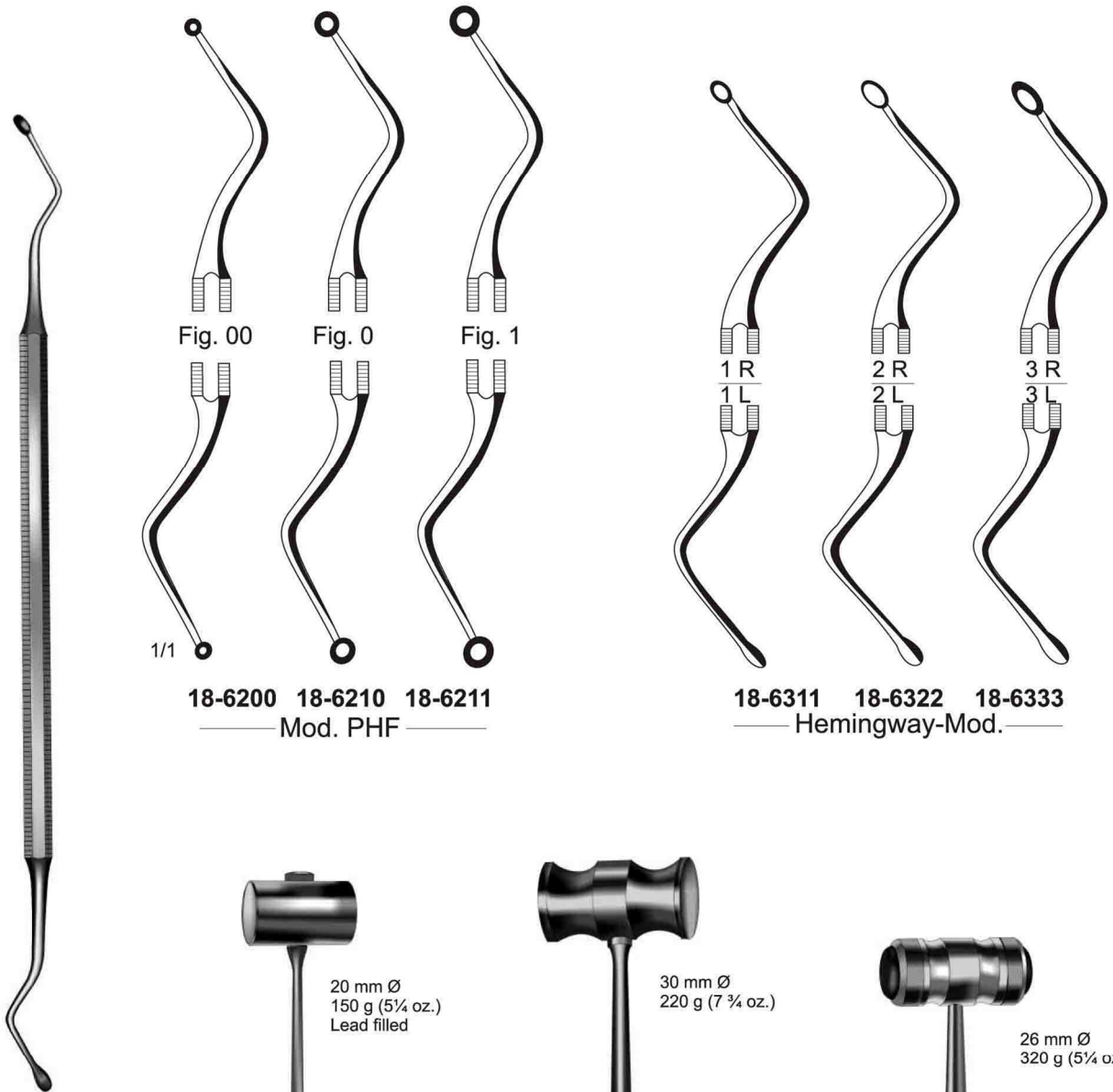

18-6200 18-6210 18-6211
Mod. PHF

18-6311 18-6322 18-6333
Hemingway-Mod.

18-6200-18-6211
18-6311-18-6333



20 mm Ø
150 g (5¼ oz.)
Lead filled

PM.01.16
16,5 cm / 6½"



30 mm Ø
220 g (7¾ oz.)

Collin
PM.05.20
20 cm / 8"



26 mm Ø
320 g (5¼ oz.)

With interchangeable
ferrozell faces
fiber
18cm

Mead
PM.06.19
Massive - solid
17 cm / 6¾"

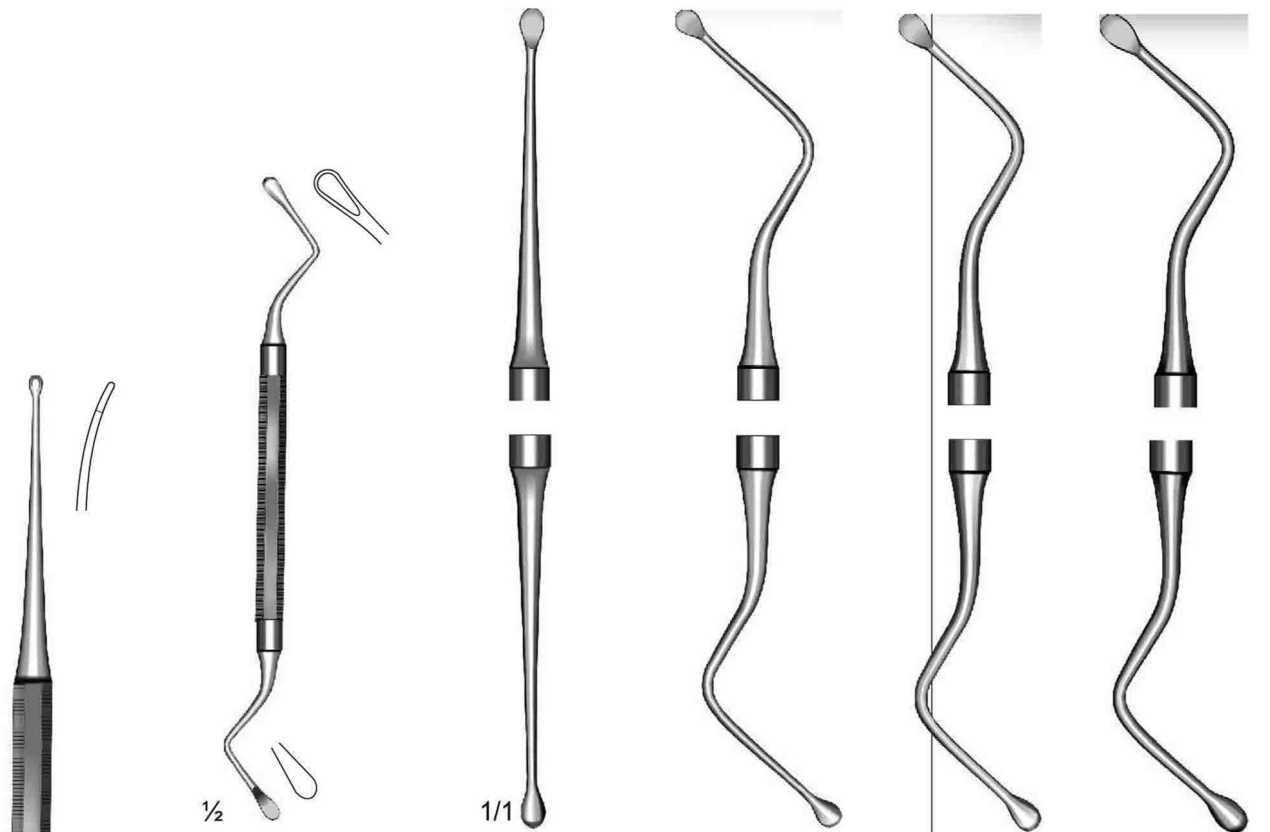

1/2

1/1

Miller-Colbrun
18-6411 - 18-6444

18-6411

18-6422

18-6433

18-6444

Miller-Colburn

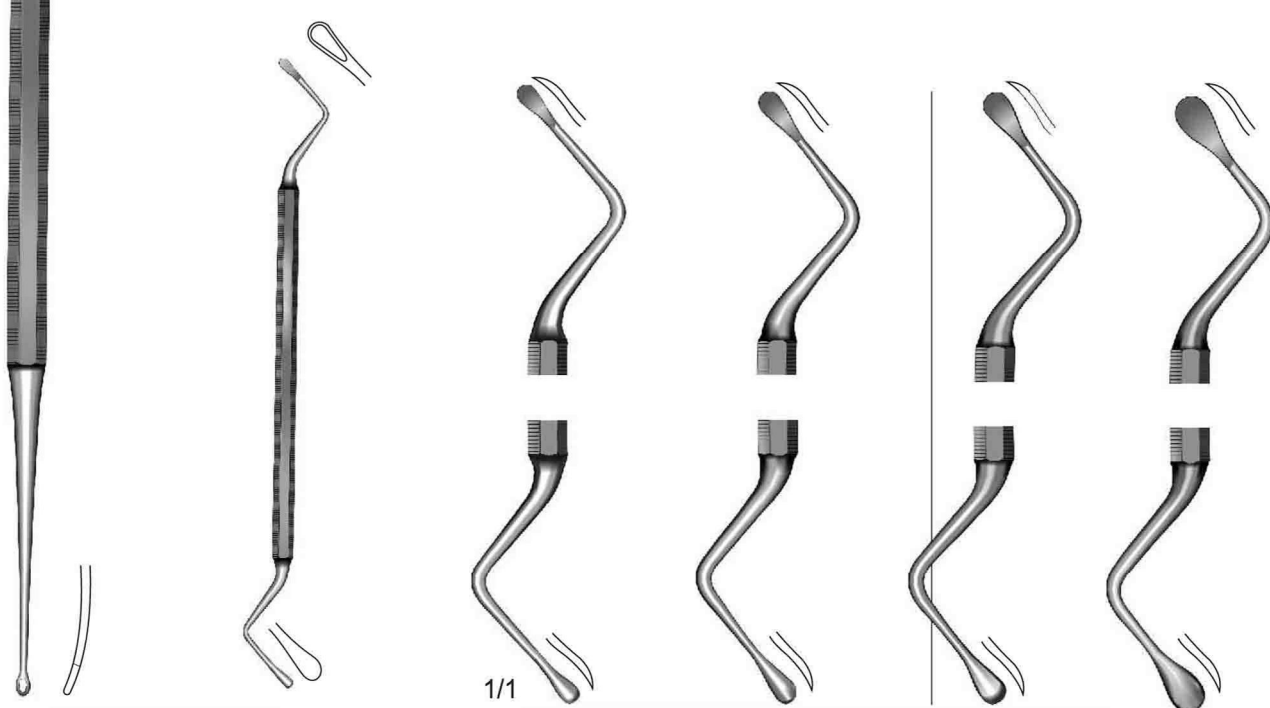

1/1

18-6401

Lucas
18-6501 - 18-6504

18-6501

18-6502

18-6503

18-6504

Lucas



Wieder
**PAS.02.21-
PAS.02.22**

